

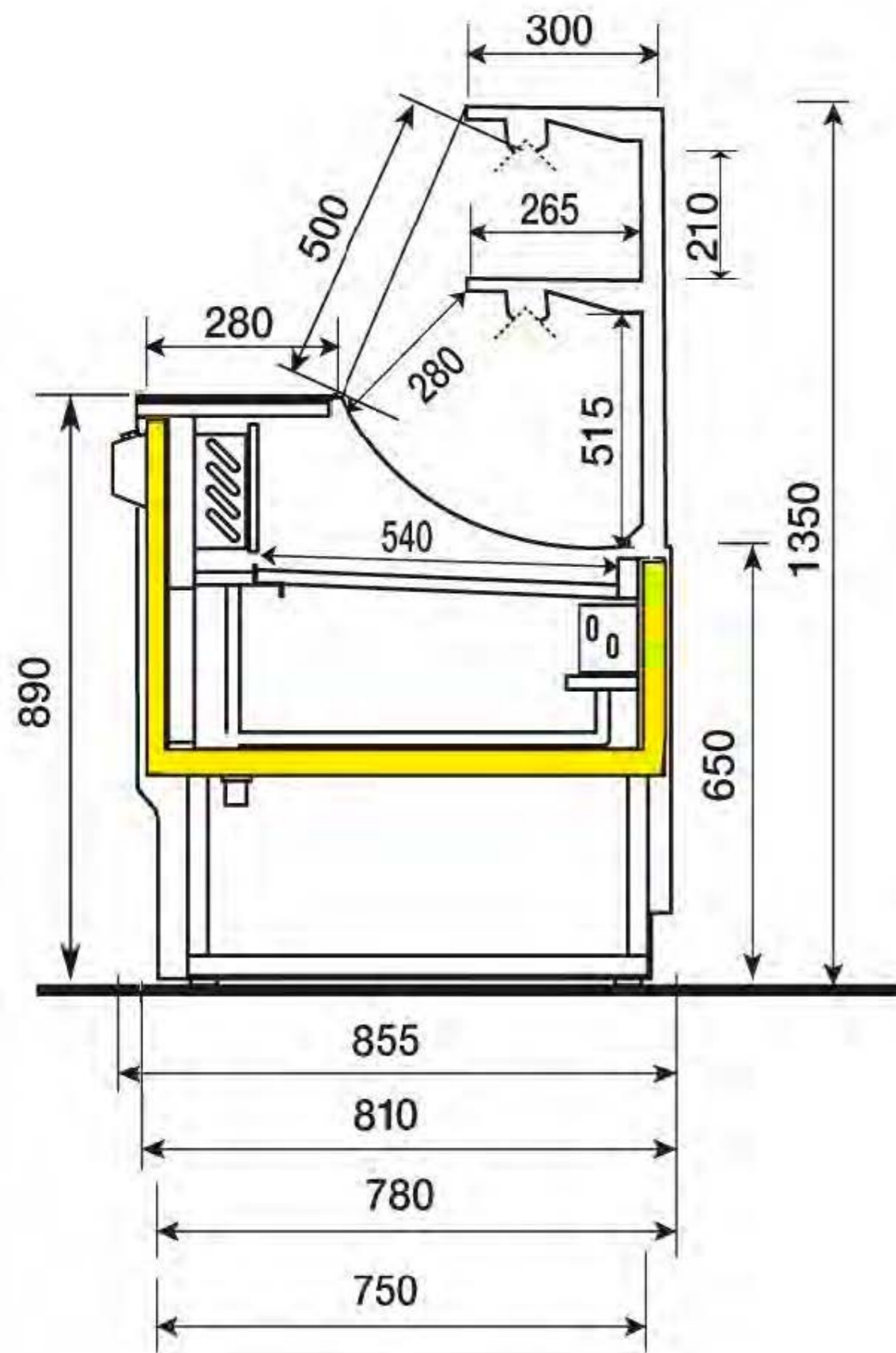

MOD : OL200/A2-R/R2

Production code : OC200PSSG170H

08/2023



MODELLO	LUNG. LENGTH LAENGE LONGUEUR	MOTORE COMPRESSOR KOMPRESSOR COMPRESSEUR	ILLUMINAZIONE LIGHTING BELEUCHTUNG ILLUMINATION	QUANTITA' GAS GAS QUANTITY GAS MENGE QUANTITE' DE GAS (KG.)	TIPO DI GAS KIND OF GAS GAS-TYP TIPE DE GAZ	HP	Potenza frigorifera Refrigeration power Kalteleistung Puissance frigorifique Watt (-10°C)	Watt assorbiti Watt absorbed Nennleistungsaufnahme Watts absorbés
	STATICO - STATISCH - STATIC - STATIQUE - ESTATICA							
ORLEANS	100	EMT6144U	2 x 14w	0,065	R 290	1/4 HP	338	193
	150	EMT6144U	2 x 28w	0,075	R 290	1/4 HP	338	193
	200	EMT6165U	2 x 35w	0,095	R 290	1/3 HP	484	274
	250	NEK6210U	4 x 21w	0,105	R 290	1/2 HP	690	373

S= ASPIRAZIONE - SUCTION - ASPIRATION - SAUG
D= MANDATA - DISCHARGE - DECHARGE - DRUCK

Modello ORLEANS	Revisione: 00
Codice: OC	Data: 01-01-2018