

08/2021

Mod: R020/B5-R2

Production code: TB200PSSND97H

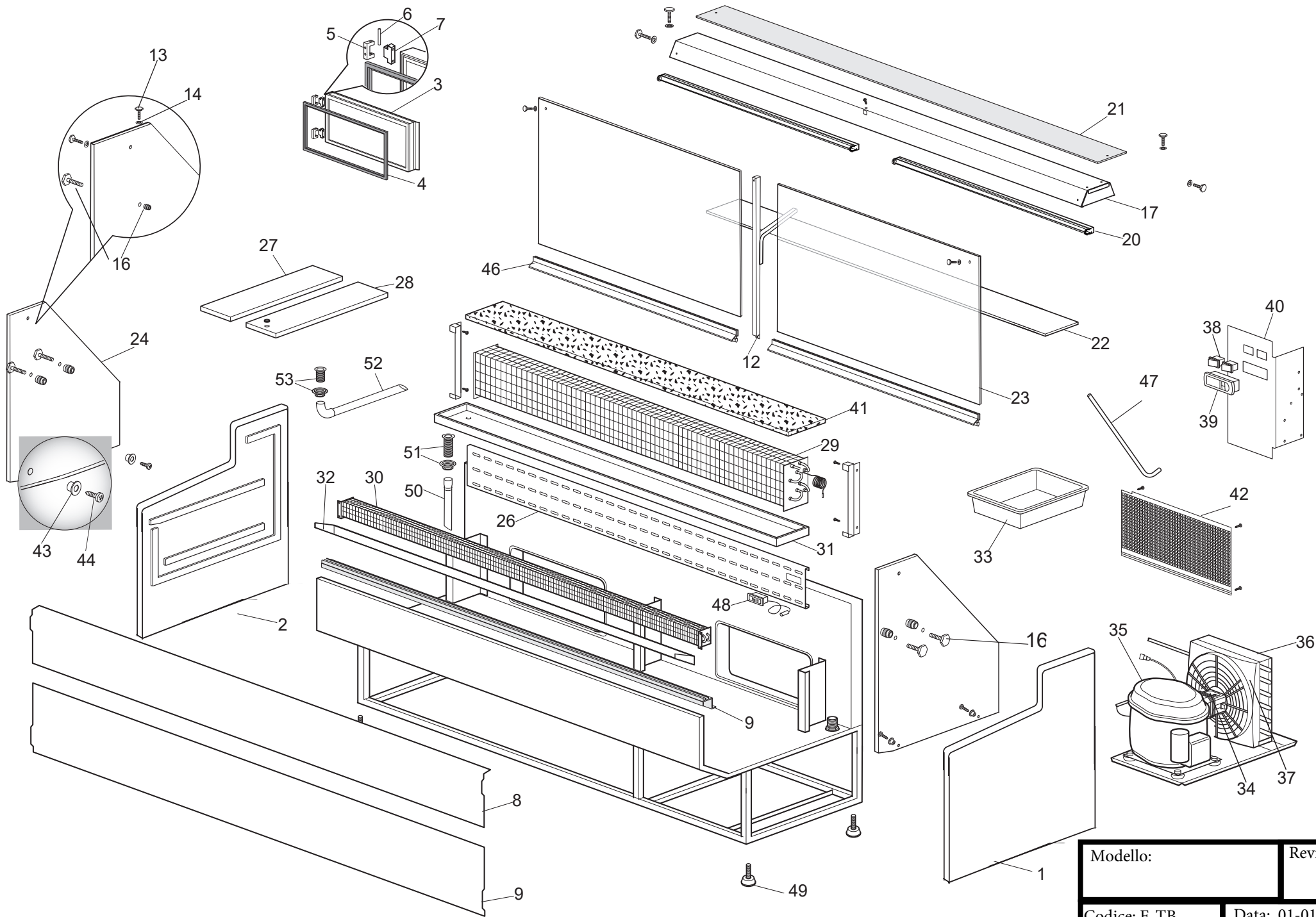

Modello:	Revisione:
Codice: E-TB	00
Data: 01-01-2020	