



MOD : OL250/A2-NN

Production code : OL250NNG170H

08/2023

1. IMPORTANT INSTRUCTIONS AND SUGGESTIONS

Before using the equipment it is important to read these instructions carefully and keep them, as well as the **CE** Certificate of conformity (that is included inside the envelope), for future reference.

Inside this manual, the following signs are used to highlight particularly important information:

⚠ ATTENTION

The risks described with this symbol indicate a danger that, if not avoided, could cause injuries for the users and/or damages to the equipment.

ⓘ OBLIGATION

This symbol indicate an OBLIGATION; it marks operations that have to be performed and if are not respected there could be injuries to the user, or the safety of the staff could be jeopardised, or the equipment could be damaged.

🚫 PROHIBITION

This symbol indicates a PROHIBITION; it marks prohibited operations that if not respected could damage the user, or jeopardise the safety of the staff and/or damage the equipment.

AN IMPROPER USE OF THE EQUIPMENT CAN BE DANGEROUS. THE MANUFACTURER CANNOT BE HELD RESPONSIBLE FOR ANY DAMAGE RESULTING FROM IMPROPER, ERRONEOUS AND UNREASONABLE USE.

Before connecting the refrigerated unit, make sure that the power supply voltage is as indicated on the label (fig. C). To guarantee the electrical safety of this equipment, it must be connected to a grounded power socket in compliance with the current legislation of the destination country.

For usage of the unit, as every electrical device, basic rules have to be followed:

- 🚫 During the use of the equipment it is forbidden:
 - to touch or plug the equipment with damp or wet hands or feet;
 - to use the equipment with barefoot;
 - to pull the electrical cable to unplug it;

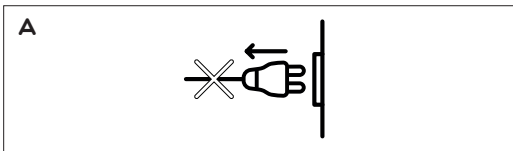

- to expose the equipment to the atmospheric agents (sun, snow, rain, etc.);
- to wash the equipment with water jets;
- to allow children to use the equipment without adult supervision and make sure that they do not play with the equipment;
- to start any cleaning or maintenance operation without unplugging or disconnecting the equipment;
- to cover the cabinet with clothes or other things during its working;
- store combustible materials such as paper, rags, cloths, chemicals, etc. on the surface under the unit.

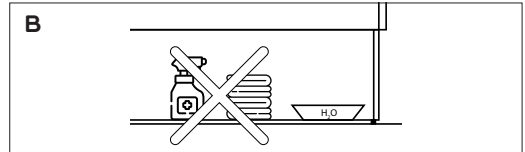

- the refrigerated showcase is designed and built for the exclusive display of fresh foodstuffs. It is forbidden, therefore, to introduce any other type of different goods such as pharmaceuticals, fishing lures, etc.

- ⓘ In case of breakdown or bad functioning, disconnect the unit and do not attempt to make any modification.

- ⚠ This appliance is not intended for use by persons (including children) with reduced physical, sensory or mental capabilities, or lack of experience and knowledge, unless they have been given supervision or instruction concerning use of the appliance by a person responsible for their safety.

2. USE AND CONSERVATION OF THE MANUAL

- ⚠ Read carefully this manual before putting the equipment into operation or before making any operation on it. Otherwise you could not be able to identify possible dangers that could cause death or bad injuries to yourself or other people.

This manual has the purpose of giving all the necessary information for a correct use and for an independent and safe management of the equipment.

The users and the technicians must carefully read the instructions contained in this manual and its attachments, before making any operation on the equipment.

If in doubt about the correct interpretation of the information given in the manual, contact the producer to have the necessary explanations.

- ⓘ Keep this manual, and all the attached documentation, in good conditions, readable and complete in all its parts.

Keep the documentation near the equipment and in an accessible place and known to all operators and

maintenance personnel and generally to all the people that for different reasons have to operate with the equipment.

- ⊘ It is forbidden to remove, edit or otherwise modify the manual pages and their content.

The manufacturer accepts no responsibility for any damage to people, animals and things, caused by the failure to observe the warnings and operating procedures contained in this manual.

- ⚠ This manual is an integral part of the equipment and has to be kept for future reference.
- ⚠ This manual has to be delivered together with the equipment if it is given/sold to another user.
- ⚠ In case the manual is lost or deteriorated, require a copy to the Manufacturer specifying the identification details of the equipment that are indicated in the identification plate: model name, serial number and production year.

3. HANDLING AND TRANSPORT

The equipment is packed in a wooden crate which is suitable for lifting by fork lifts or transpallette, in order to avoid possible damages. The equipment must be moved by qualified personnel. The packing containing the equipment has to be handled carefully, using a fork lift, avoiding impacts or falls due to a bad slinging, that could damage the integrity of the product.

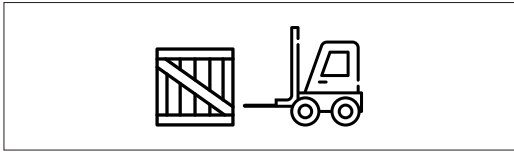

It is recommended to use proper individual protection devices according to the laws of the country (ex. approved gloves of class II, shoes, etc.).

- ⊘ During the handling of the equipment to install it on its place, never pull it on its side ends.

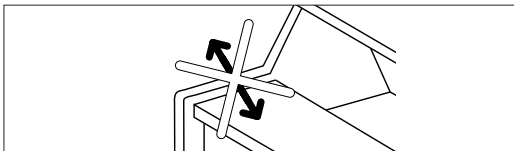

4. UNPACKING

The packing materials can be recycled, therefore they must not be dispersed, but they have to be disposed in the special waste plan for recycling. Keep the packing away from children. It is advisable to use a wooden board for any handling of the equipment in order to avoid damage.

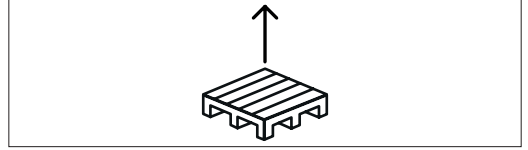

- ⚠ Carefully unpack the cabinet.
- ⓘ During the unpacking pay attention to the various components.
- ⊘ During the unpacking it is prohibited to throw parts necessary for the assembling away, considering that in some models there are glasses and also inside the packing you will find all the necessary assembling parts (for example screws).

5. STORAGE

In case of prolonged stop of the equipment, after having used it, make a full cleaning of the equipment and keep it away from all weathers.

6. COMPLAINTS

On receipt of the refrigerated equipment, verify immediately if there are transport damages. In case the unit is damaged in any way, notify immediately the driver and, within 3 days, the shipping company by registered letter. Every complaint must arrive at the manufacturer within 8 days from receipt of the equipment. After this term, the manufacturer will not take any responsibility. The manufacturer is not responsible for any damage caused to the refrigerated cabinet during the transport and storage.

7. INTENDED USE AND WORKING TEMPERATURE

This equipment is manufactured to store foodstuffs and is manufactured in conformity with the ambient conditions of climatic class 3 (25°C – 60% R.H.) according to the standard UNI EN ISO 23953:2006, and the refrigeration power has been calculated referring to the climatic class 3.

The refrigerated unit maintains its performance characteristics with an ambient temperature and relative humidity of no more than the ones indicated in the table, ensuring

the exchange of air in the environment even when the room is closed:

Max. allowed ambient temperature	R.H. Max allowed relative humidity
+25°C	60%

⚠ In case the ambient conditions are not included in the above mentioned ones, a lower performance must be expected.

The ambient where the equipment is installed has to be proper and in conformity with the hygienic and sanitary rules in force.

8. IDENTIFICATION - PLATE DATA

C

MODELLO :		1	
MATRICOLA / SERIAL NO. :		CODICE / CODE :	
2		3	
ANNO DI FABBRICAZ. / MANUFACT. YEAR :		4	
5	REFRIGERANTE / COOLING FLUID :	Q.TA REFRIG. / WEIGHT COOLING FLUID :	6
7	8	9	10
6	11	12	13
9	POT. ASSORBITA / INPUT POWER :	TENSIONE VOLTAGE :	14
13	W	230 V / 50 Hz ~	MAX PRESS. kPa (bar) :
8	14	1800 (18)	
CAP. NETTA CELLA / NET LOAD RESERVE :		Lt	
CLASSE CLIMATICA / CLIMATIC CLASS 3/ SN			
POTENZA MAX EROGABILE SE DOTATO DI PRESA: 1000 W			

A serial plate is affixed behind the equipment, stating all its identification and characteristic data:

- 1) Manufacturer's name and address
- 2) Equipment name and description
- 3) Equipment code
- 4) Equipment serial number
- 5) Kind of refrigerant fluid
- 6) Mass of refrigerant gas with which the unit has been loaded (only for equipment with built-in motor)
- 7) Production year
- 8) Climatic class
- 9) Supply voltage and frequency
- 10) GWP
- 11) CO₂
- 13) Absorbed electrical power
- 14) Max. pressure inside the circuit

9. INSTALLATION

The equipment must be installed in a suitable, not windy place and on a level floor in order to prevent noise and vibrations during the working of the unit and also to avoid higher energy.

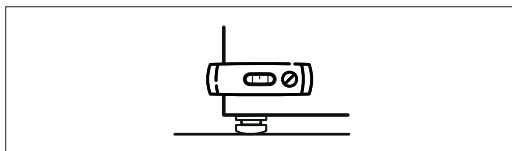

- ⊘ During the installation procedure, it is prohibited to:
- Tilt the cabinet, as the lubricating oil contained in the cabinet itself could enter the cold circuit and the latter could suffer irreparable damage.
 - Correct possible imperfections of the floor level with pieces of wood, carton or similar, but use only the feet screwing or unscrewing them (without taking them off) until you reach a perfect levelling.
 - Install the equipment near sources of heat such as radiators, direct or indirect sunlight or other equipment which produce heat;

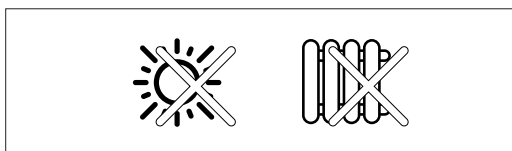

- Install the equipment in line with draughts coming from doors, windows, cooling fans or air-conditioning systems.

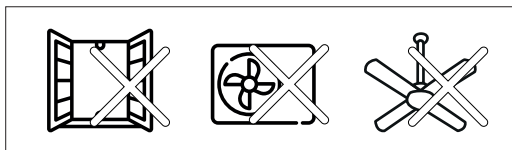

- Close or obstruct the ventilation openings of the refrigerating unit, because this would stop the airflow which cools the refrigeration unit causing bad working.

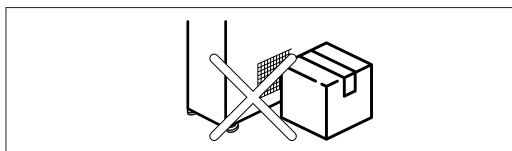

10. ASSEMBLING

The equipment has to be completed according to the assembly instructions contained in the paper box coming along with the packaging. The appliance must be placed on the location and set by specialized personnel.

11. ELECTRICAL POWER/CONNECTION

- ⚠ The equipment has to be completed with the assembling of the shelves and for some models also of the glasses that have to

be assembled by qualified people after the equipment has been positioned on its place. The assembling instructions are contained in the envelope that is supplied inside the packing.

The equipment has to be positioned on its definitive place and levelled by qualified people.

The unit is equipped with the plug and electrical cable mod. Schuco. It can also be a British G Type.

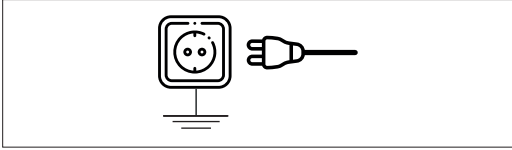

The cable has to be connected at 3 mt. max. to a 0,03A differential fused isolator. NEVER CONNECT THE CABLE TO MAIN SUPPLY LINE DIRECTLY.

Verify that the power supply voltage is as indicated on the machine rate plate (fig. C).

Power supply	
230 V	50 Hz single phase
220 V	60 Hz
110 V	60 Hz

To ensure correct operation, the maximum voltage variation must be between +/- 6% of the nominal value.

We recommend to connect the unit to a dedicated circuit and not to use damaged sockets, extension sockets or multiple sockets.

In case of incompatibility between the socket and the plug of the refrigerated cabinet, the plug should be replaced with a suitable one by a qualified technician.

For units with electric sockets the maximum rating is 1000 W.

- ⊘ During the electrical connection it is forbidden:
 - To use adapter sockets or extension sockets.
 - To connect other appliances to the same power socket.
 - To pull the electrical cable or the unit to unplug the equipment from the socket (fig. A).
 - To use extension sockets, worn down cables, cables with damaged or fissured insulation as they are very dangerous: they could cause sparks, electric shock and fire.
 - It is absolutely prohibited to pass cables and connect other sockets under the cabinet.

- ⚠ During the electrical connection verify:
 - The power supply cable has to be laid in such a way as to prevent it from being damaged or becoming hazardous to people and things.
 - In case the power supply cable is damaged, it should be replaced only by a qualified technician (electrician) with an equivalent cable.

- The cable of the equipment should be checked regularly. If it should result that the cable is damaged or deteriorated, disconnect the equipment and do not use it and let the cable be replaced with an original replacement part by an authorised technician.
- Protect the cable in such a way as to prevent twisting or interlacement with other cables, trample on, crushing, stretching.
A wrong installation could cause damages to people, animals or things, for which the manufacturer cannot be deemed responsible.

12. FIRST CAREFUL CLEANING

- ⓘ DURING THE WHOLE CLEANING OPERATION USE WORKING GLOVES OF CLASS II TO PROTECT YOUR HANDS ALL THE TIME AND THE PERSONAL PROTECTIVE EQUIPMENT ACCORDING TO THE LAW OF YOUR COUNTRY.

Before switching on the unit, take away the protective film that covers some external and internal parts of the cabinet (for example display surface, shelves, front decoration panels, etc.). Clean the refrigerated cabinet thoroughly, both inside and outside, using warm water (max. 30°C) and a solution of bicarbonate of soda (1 tea spoon every 2 liters) or white vinegar. Carefully dry the unit with a soft cloth.

- ⊘ During the cleaning operation it is forbidden:
 - To use detergent products, metal pads or abrasive substances that could damage the aesthetic appearance of the equipment.
 - To use sharp objects (any damage resulting from the use of these objects will not be covered by warranty).
 - To spray water directly on the electric parts and to wet the electrical parts (fans, lighting, electrical cables, etc.).
 - To wash the refrigerated cabinet with water jets.

Once the cleaning is finished, switch the unit on through the ON/OFF switch and wait until the cabinet reaches the proper temperature for the products that have to be displayed. It will take approx. 3 hours for the cabinet to reach the proper temperature. The products to be displayed will have to be already cold according to the cabinet temperature.

- To switch off the display:
- Set the thermostat to 0.
 - Switch off using the ON/OFF switch.
 - Turn off the light using the ON/OFF switch.
 - Unplug the power cord.
 - Wait five minutes.
 - Clean the display.

13. LOADING INDICATIONS

This refrigerated cabinet is proper for the preservation of foodstuffs if the following rules are respected:

a) arrange the goods in the space provided in such a way that they never exceed the loading line, so as not to prevent proper air circulation.

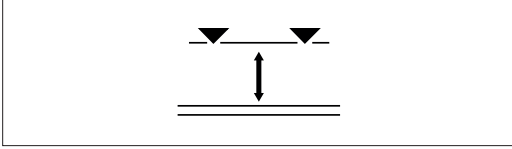

⚠ The loading line is indicated by a label on the glass. In the event of wear, replacement or repositioning, the loading line shown must be at the height of 15 cm.

b) arrange the goods evenly, without leaving any empty areas;

c) ensure correct goods rotation by removing those that have been in the cabinet the longest first. Avoid the display of fresh meat for more than 4 hours.

14. CONTROL DEVICES

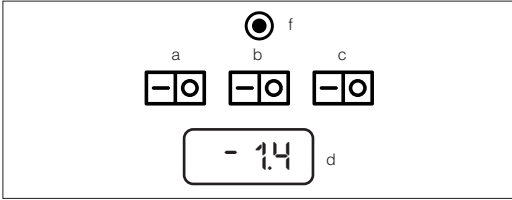

a- is for switching the unit on or off.

b- light

c- fog prevention heater (optional).

d- Electronic thermostat

e- Electric outlet (optional)

f- Thermal-magnetic circuit breaker

15. DIGITAL /MECHANICAL CONTROLLER

The thermostat is already set at the factory. In case the temperature is altered, the manufacturer will not take any responsibility. Any modification will have to be made by qualified people.

16. TEMPERATURE

The thermostat regulates the temperature into the equipment and the working temperature is already preset at the factory.

A lower performance must be expected from the refrigerated unit when:

- the equipment is set on the lowest temperature

- the equipment is positioned in an ambient with higher temperature or relative humidity than above indicated

- the amount of displayed goods exceeds the maximum recommended and the proper air circulation is prevented. In those cases the goods are kept at higher temperatures, the refrigerating unit has to run non-stop and ice may form on the evaporator. It is necessary therefore to turn the equipment off to allow the complete melting of the ice. During this phase do not use any kind of sharp object to make the melting of the ice quicker, because you could cause big damages to the equipment. Once the ice is completely melted, switch the equipment on through the ON/OFF switch (as indicated in paragraph 12).

17. DEFROSTING

The defrosting takes place automatically during the running of the unit. The defrosting cycles are 6 a day and last for about 40' each.

Defrosting must be done manually by turning off the display unit as and when necessary.

During the defrosting phase the temperature of the unit could be altered, but when this cycle is over, in a short time the working temperature will return to normal.

⚠ The defrost water is collected in a bowl, which must be emptied when necessary. The bowl is supplied with the unit and must be placed under the drain on the right as seen from the service side, as shown in figure B.

Display units with electric evaporation are also available (optional).

18. PERIODICAL MAINTENANCE AND CLEANING

We suggest to carry out a daily/weekly cleaning of the external parts of the equipment and a monthly thorough cleaning of the internal parts of the refrigerated cabinet for the good working, the good preservation of the food and the aesthetics preservation of the equipment. The cleaning has to be made by qualified people, who should know the procedure described in this paragraph.

Attention! Before starting any cleaning operation it is necessary to turn off the equipment by the on/off red switch and to unplug or disconnect the equipment by the general power security switch of your shop.

⚠ DURING THE WHOLE CLEANING OPERATION USE WORKING GLOVES OF CLASS II TO PROTECT YOUR HANDS ALL THE TIME AND THE PERSONAL PROTECTIVE EQUIPMENT ACCORDING TO THE LAW OF YOUR COUNTRY.

Remove all goods from the refrigerated unit and keep them in a fridge or in a refrigerated ambient suitable for their preservation. Carefully and thoroughly clean the

display surface, the shelves, the glasses with specific cleaners for any surface.

- ⊘ Do not use acid and alkaline detergents, chemical / organic solvents, unknown chemical composition detergents.

During the maintenance and cleaning it is forbidden to use abrasive substances and/or sharp tools which can damage the unit.



After every cleaning operation it is necessary to rinse with warm water and dry the unit with a soft and clean cloth.

Clean the condenser, after having removed the cover grid, with a dry paint brush (do not use iron brushes) or a vacuum cleaner, removing all dust and possible deposits on the fins.

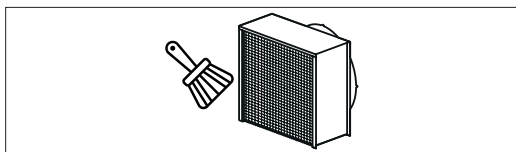

- ⚠ During the maintenance and cleaning pay attention not to bend or damage the fins and the whole refrigerating unit.

Never neglect this operation, as it is basic for the good working of the unit and to avoid possible breakings. When you have finished this operation, fit the cover grid in its original position.

When the cleaning operation is over, make sure that everything is clean and dry before connecting the equipment to the power supply again. When the unit reaches the correct working temperature, it is possible to reload it. In case of long absences (i.e. holidays etc.) the unit has to be unplugged, emptied completely, cleaned and dried to prevent bad smells.

A correct maintenance of the equipment can considerably prolong its life.

19. TECHNICAL ASSISTANCE - SERVICING

- ⚠ If the equipment does not run properly or does not work at all, in your own interest before calling for servicing, we suggest to check the following points:
 - if the plug is well inserted in the socket;
 - if the power reaches the socket to which the equipment is connected;
 - if the thermostat is set as recommended;
 - if the network voltage is the same as requested for the equipment (+-6%);
 - if the evaporator is covered with ice (in this case

- proceed as indicated at paragraph 16);
- if the condenser is clean (paragraph 18);
- if there are air draughts, if the cabinet is installed in the correct position (see paragraph 9) and if the ambient temperature is as indicated (see paragraph 7).

20. REPLACEMENT OF LED CEILING LAMP

The replacement and the substitution of led ceiling lamp must be made by qualified technician and when the unit is disconnected from the power net.

Before replacing the led ceiling lamp disconnect the equipment by the general power supply. During the whole replacement operation use proper working gloves.

21. EMERGENCY SITUATIONS

Devices to be used in case of fire: powder-extinguishers or liquid- extinguishers complying with the current legislation.

22. DISMANTLING THE UNIT

- ⚠ The unit must be disposed of in accordance with your country's waste management legislation.
- ⚠ IN CASE OF REQUEST FOR SERVICE, CONTROL AND/OR REPLACEMENTS YOU WILL HAVE TO CONTACT THE SUPPLIER WHERE THE CABINET WAS BOUGHT.

23 . ATTACHMENTS

1. EC declaration of conformity
2. Thermostat instructions.
3. Assembly instructions



Keep the counter away from free flames or sources of ignition.

⚠ IN CASE OF DAMAGE
Keep the counter away from free flames or sources of ignition
Thoroughly ventilate the area for a few minutes. Switch off the counter and disconnect the power plug. Contact customer service. The more refrigerant is inside the unit, the larger the environment where it is located must be.
In smaller environments leaks can lead to the formation of a flammable air/gas mix. The volume of the room where the counter is located must be at least 19 m³ for every refrigerant system present.

STANDARDS AND RECOMMENDATIONS FOR DISPLAY COUNTERS WITH R290 - PROPANE - REFRIGERANT GAS

ZOIN SRL refrigerated display counters with R290 gas contain a quantity of gas of less than 150 g.

It is however necessary to take the following precautions:

- Do not obstruct the vents.
- Do not use mechanical devices or other means to accelerate the defrosting process other than those recommended by the manufacturer.
- Do not store explosive substances inside the units, such as pressurised containers filled with flammable propellants.
- All repairs must always be carried out by qualified personnel complying with the safety standards for this type of gas.
- All equipment used for such activities must be suitable for this type of gas.
- When replacing components, these must only be replaced with original components approved for the specific use.
- The disposal of the counter should be entrusted to a specialist disposal centre in accordance with the laws of the country of installation.

⚠ The cooling circuit contains pressurised R290 gas. It can explode if heated.

⚠ THIS PRODUCT CONTAINS HFC, A COOLANT WITH A HIGH GREENHOUSE EFFECT POTENTIAL, IN A HERMETICALLY SEALED UNIT AND THE COOLANT LOAD IS LESS THEN 3 KG.

WARNING: DISPLAY COUNTERS FILLED WITH R290 REFRIGERANT



The R290 refrigerant gas is compatible with the environment but highly flammable. Pay the utmost attention during the transport, installation and disposal of the counter, to avoid damage to the pipes of the refrigerant circuit.

ELECTRICAL DIAGRAM

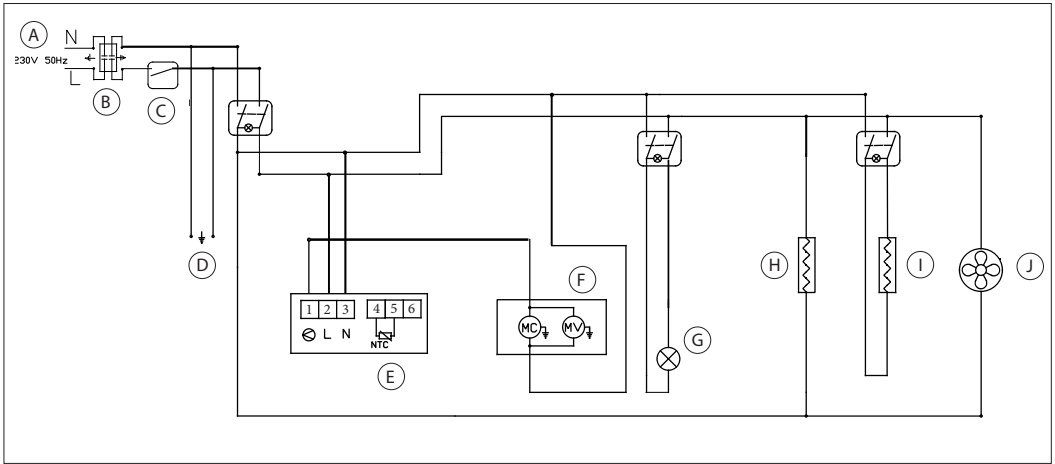
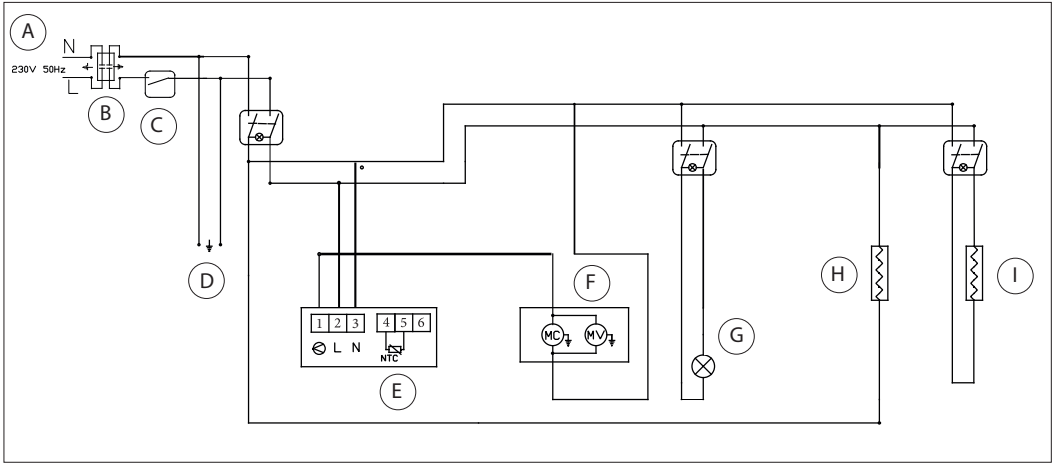

- A - PLUG
- B - FILTER
- C - MAGNETOTHERMAL SWITCH
- D - MAX. SOCKET 1000 W (OPTIONAL)
- E - UNIT THERMOSTAT
- F - WITH UNIT
- G - LIGHT
- H - ELECTRIC TANK RESISTANCE (OPTIONAL)
- I - FOG PREVENTION HEATER (OPTIONAL)
- J - EVAPORATOR FAN