

MOD : CSL2509-VTM

Production code : HPL/2504

04/2026



Connection diagram

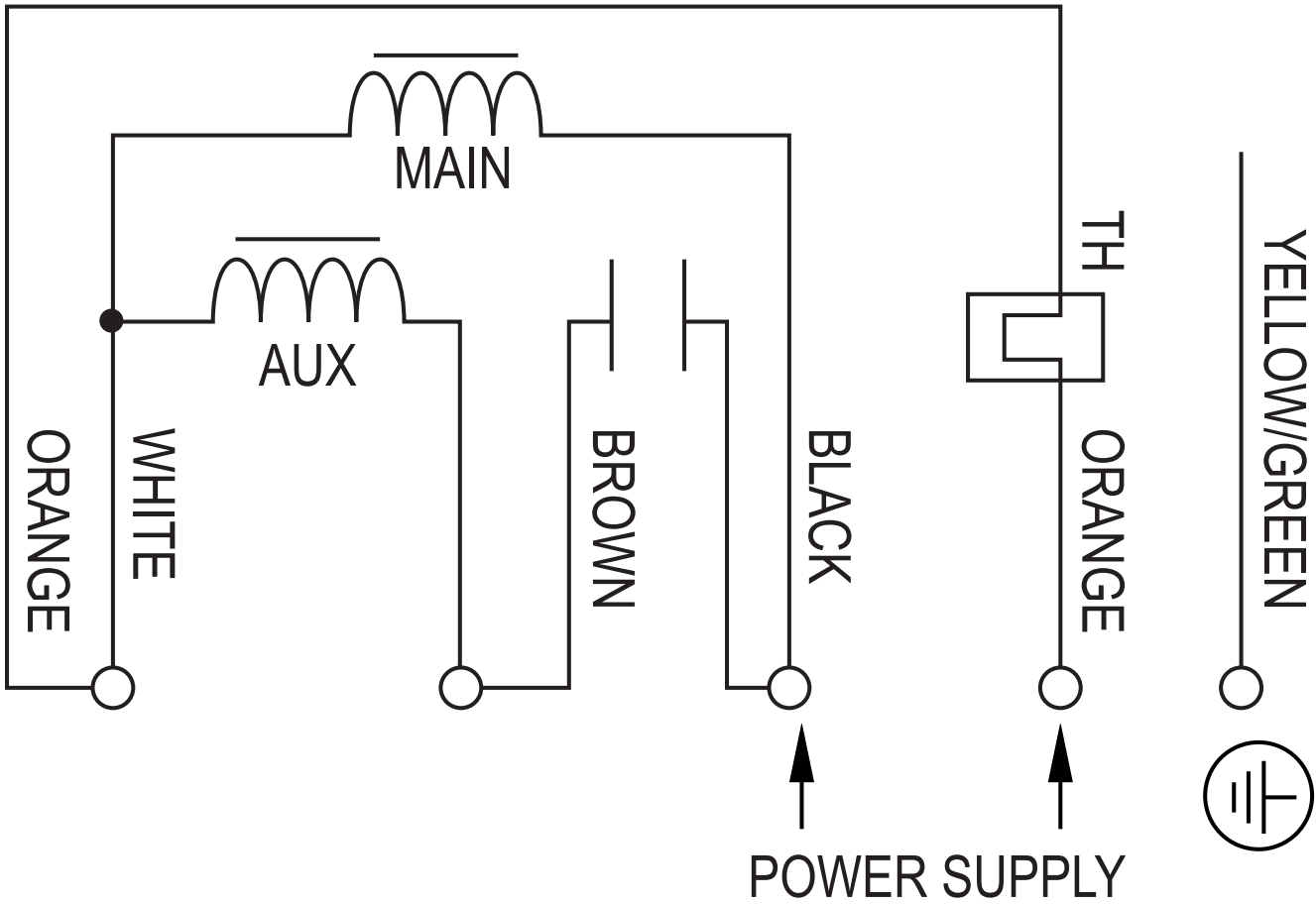

BLACK
BLUE
RED
YELLOW
BROWN
GREEN
WHITE
YELLOW/GREEN
ORANGE
GREY
VIOLET
SPEED 1,2,3,4
PHASE
NEUTRAL