

MOD : CSL1507-VTM

Production code : HPL/1504

04/2026

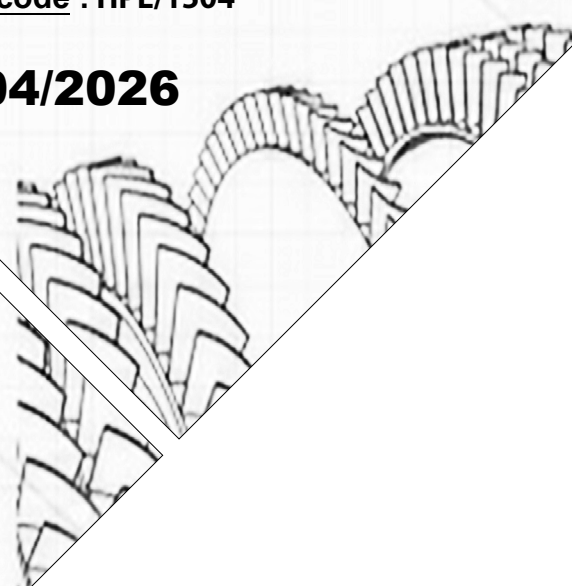

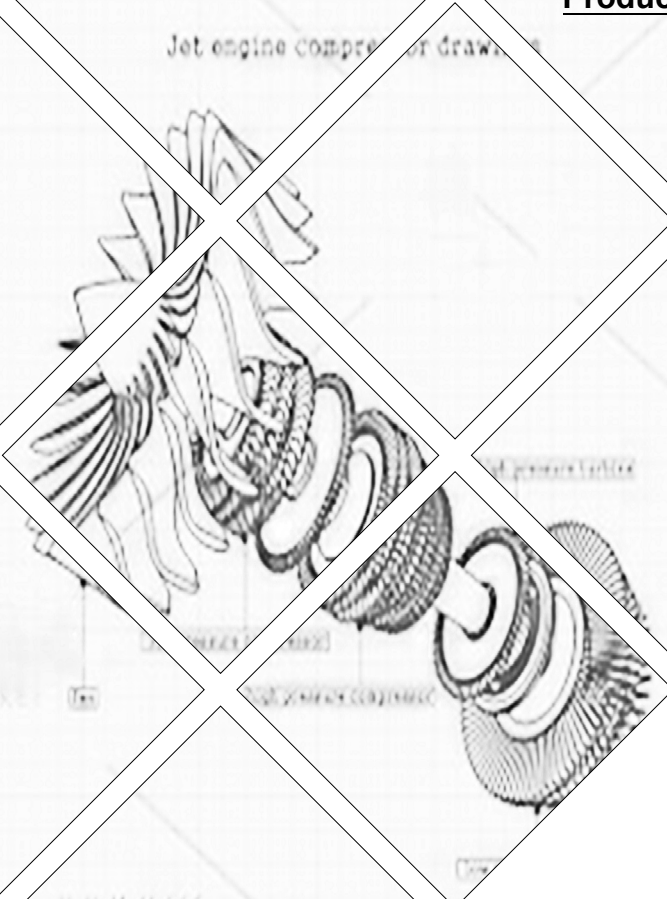
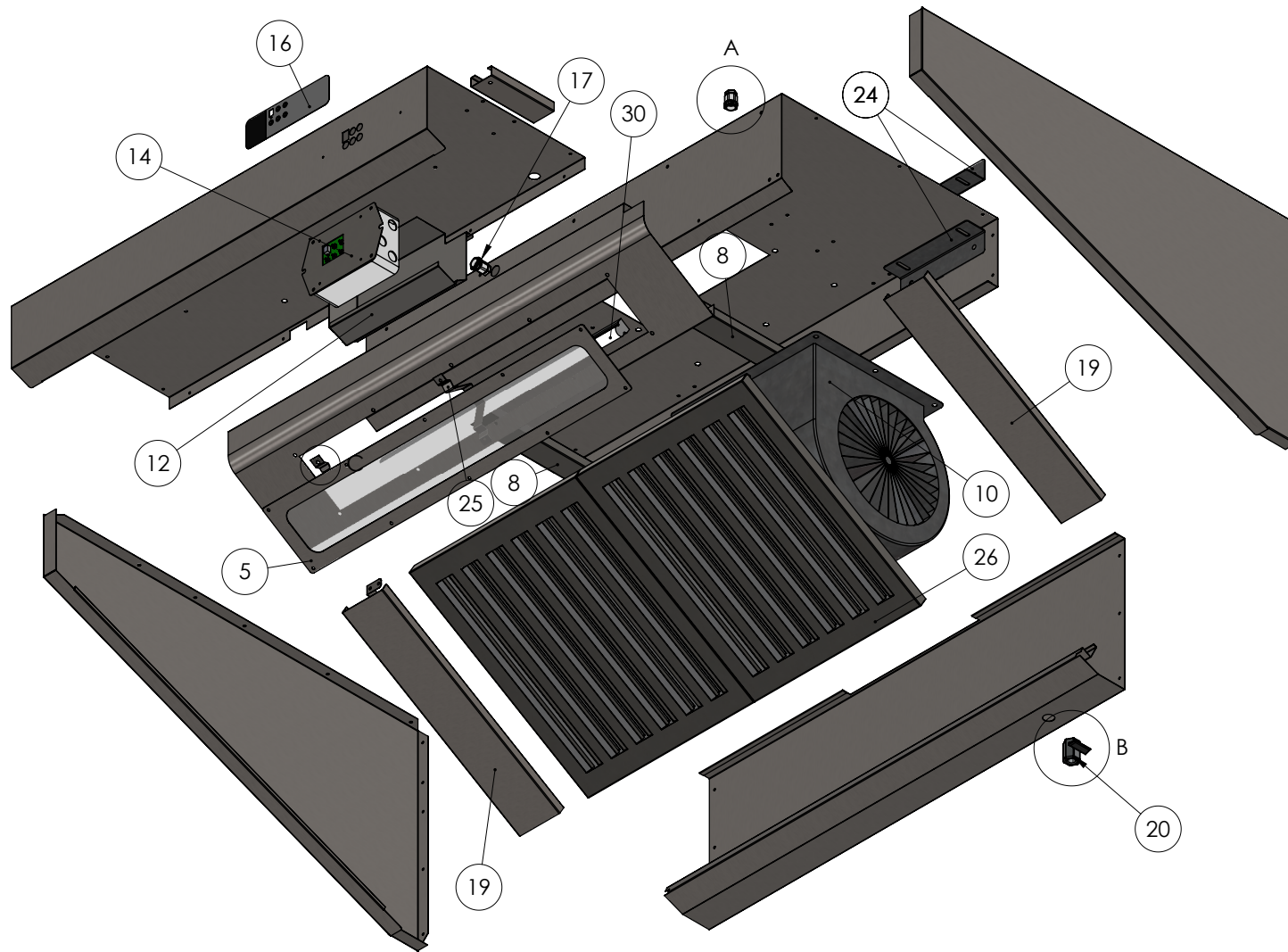

DÉTAIL A
ECHELLE 1 : 2

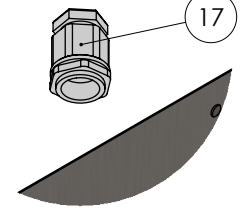

DÉTAIL B
ECHELLE 1 : 2

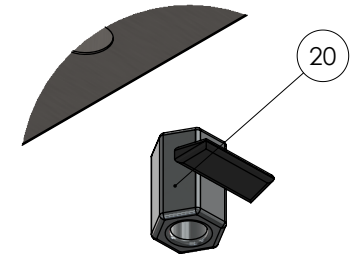

DÉTAIL C
ECHELLE 1 : 2

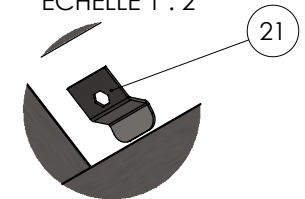

Rev.	n°	Description	Auteur
	A		
mercredi 25 septembre 2018 13:37:41	B		

création: mardi 12 mai 2015 15:31:43	A3H	Composant: Eclaté HPL	
	Echelle 1:20	n°plan:	
		emplacement: O:\solidworks\STANDARTS\HOTTES\hpl\AP PROUVE 160520\	



Dessinateur: A.Augello

matière:	
nom client :	Vérifié par:
n°commande:	

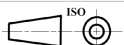

Liste des pièces de rechange conseillée HOTTE CSL

<u>numéro</u>	<u>Code interne</u>				<u>dénomination</u>	<u>designation</u>
	CSL1007-VTM	CSL1507-VTM	CSL2009-VTM	CSL2509-VTM	FR	UK
5	O0550	O0551	O0552	O0553	Cache lumière	Light cover
8	O0506	O0506	O0506	O0506	omega support moteur	Omega engine support
10	DDM 7/7-C	DDM 7/7-C	DDM 8/9T-C	DDM 8/9T-C	ventilateur ERP2015	Fan ERP2015
12	O0505	O0505	O0505	O0505	cache display	Display cover
14	FE230KIT+BOX	FE230KIT+BOX	FE230KIT+BOX	FE230KIT+BOX	variateur + box isolé	dimmer + isolated box
16	FE230KIT-LEXAN	FE230KIT-LEXAN	FE230KIT-LEXAN	FE230KIT-LEXAN	lexan pour variateur	lexan for dimmer
17	CM/04A	CM/04A	CM/04A	CM/04A	presse-étoupe conique PG11	conical cable gland PG11
19	O0801	O0801	O0801	O0801	intercalaire	intercalary
20	RG-C	RG-C	RG-C	RG-C	robinet à graisse	grease faucet
21	O0508	O0508	O0508	O0508	support plexi	plexi support
24	HPLPF	HPLPF	HPLPF	HPLPF	patte de fixation murale	wall mounting bracket
25	O0509	O0509	O0509	O0509	support LED	support LED
26	AA/4050-S	AA/4050-S	AA/4050-S	AA/4050-S	filtre labyrinthe 400x496x25	labyrinth filter 400x496x25
30	LED-060-HPL	LED-120-HPL	LED-150-HPL	LED-150-HPL	LED linear /8w/4000K	LED linear /8w/4000K