

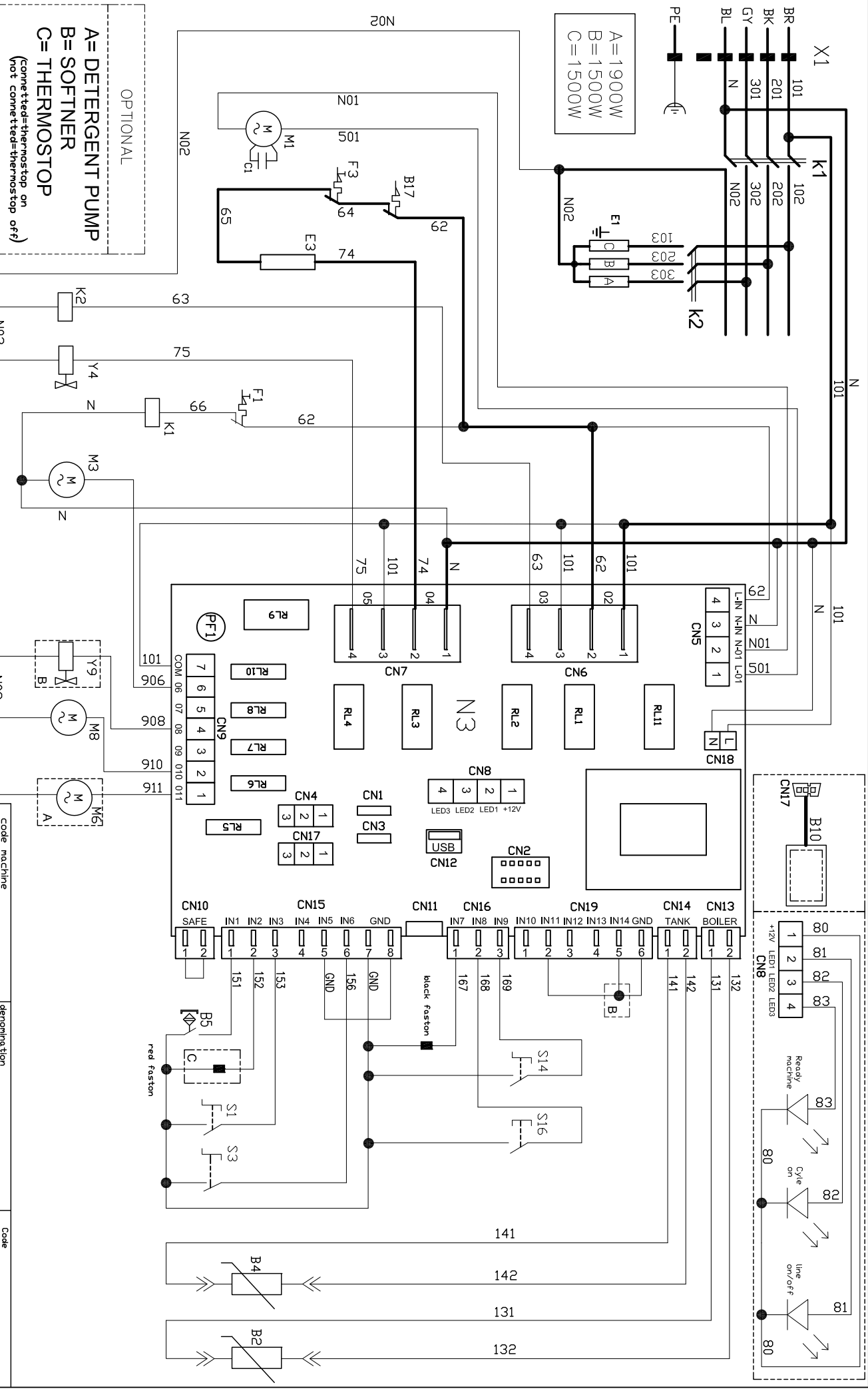

**MOD : DC502/6-PSD5**

**Production code : 919868**

**03/2026**



OPTIONAL

A= DETERGENT PUMP  
 B= SOFTNER  
 C= THERMOSTOP  
 (Cometted=thermostop on  
 (not cometted=thermostop off))

A= 1900W  
 B= 1500W  
 C= 1500W

n° MODIFICA	DESCRIZIONE	SOSTITUISCIE	DATA
-1	Aggiunto optional addolcitore su CN9,		

Code	denomination	total blact	N°blact	Next blact
1349	WIRING DIAGRAM	4	1	-

Code	n°/file	mod
1349	1349	-1

  

Code machine	re-examined	date	date	date	date
LA 500 (SP)		15/03/17	15/03/17	15/03/17	15/03/17

  

Code	validated by	date
1349	Bertolini	15/03/17

400v 3N 50hz 5,4kw 16A

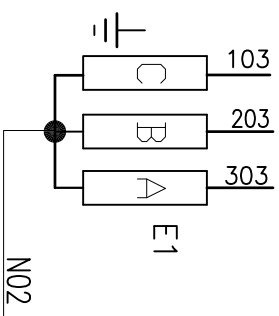
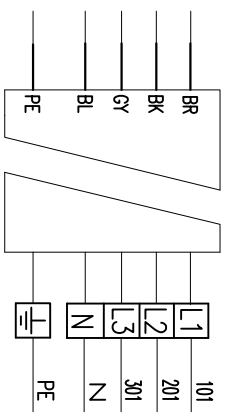
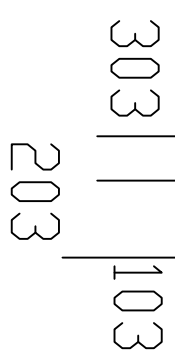
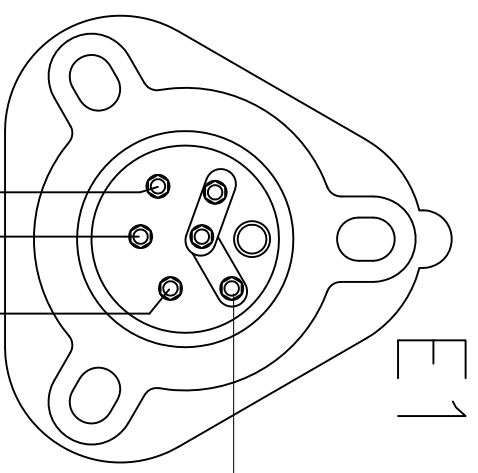

230v 3 50hz 5,4kw 16A

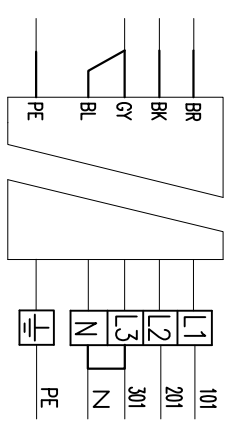
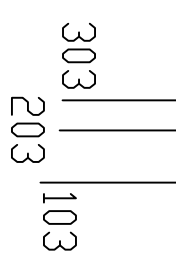
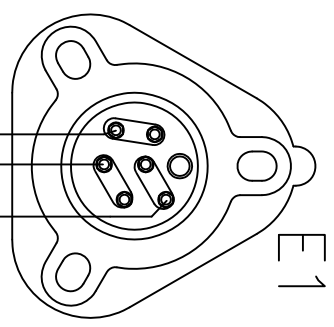

230v 1N 50hz 3,5kw 16A

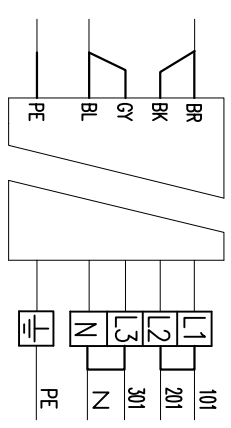
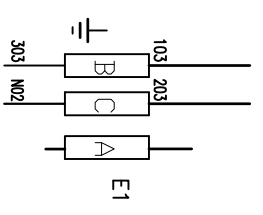
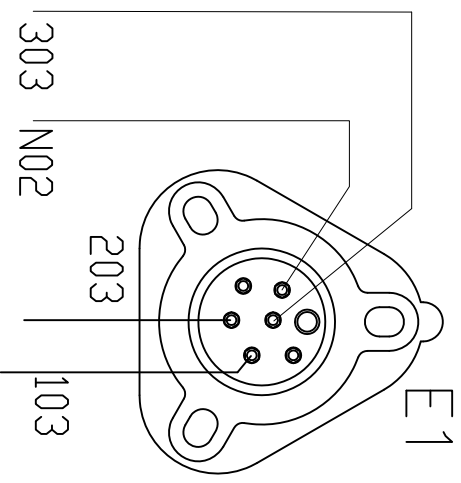

DESCRIZIONE

SOSTITUISCE

DATA

A= 1900W  
B= 1500W  
C= 1500W

code machine

re-examined

inspected by

validated by

date

date

date

demonstration

WIRING DIAGRAM

Diswashers

total Blatt

nr Blatt

next Blatt

Code

1349

n°file

1349a

mod

-1

01 02 03 04 05 06 07 08 09 10 11 12 13 14 15 16 17 18

**\*  
OPTIONAL**

**Front panel**

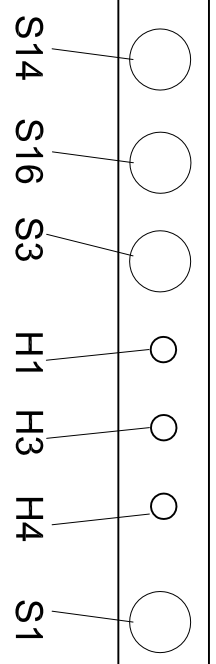

**REAR**

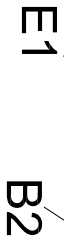
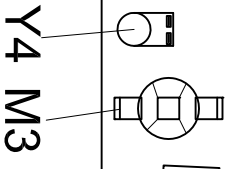
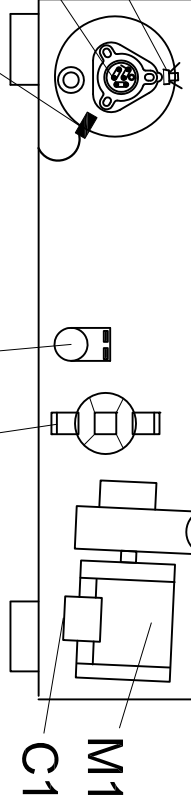
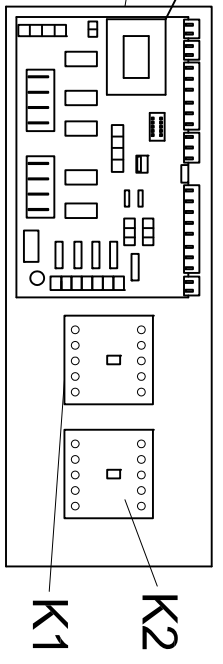
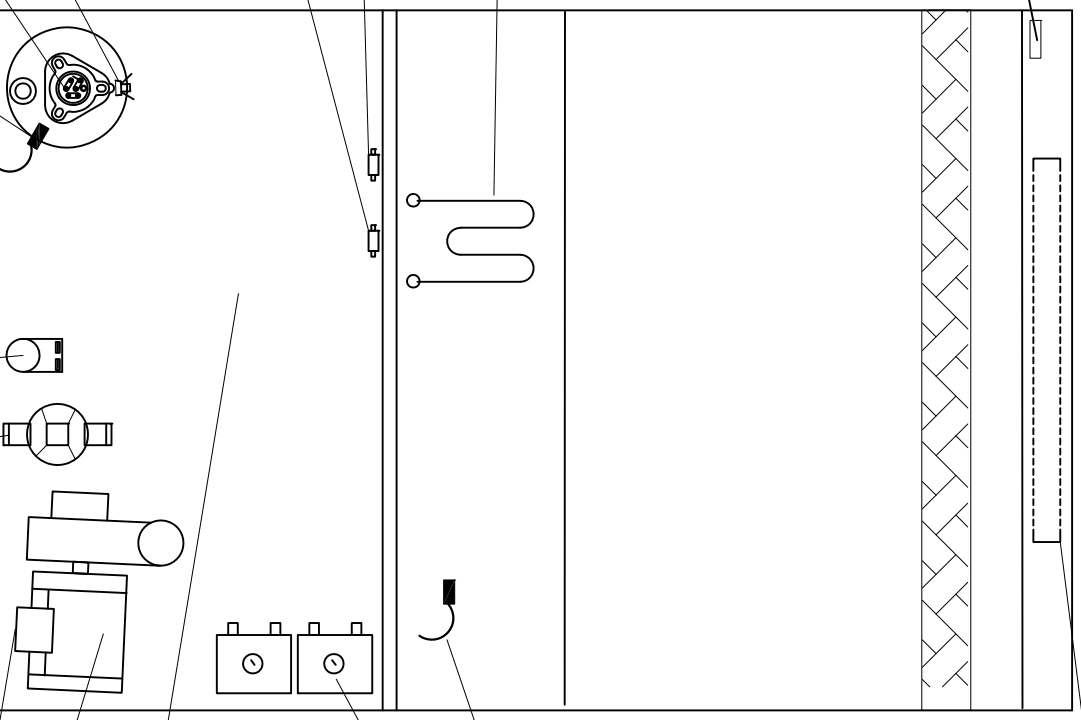
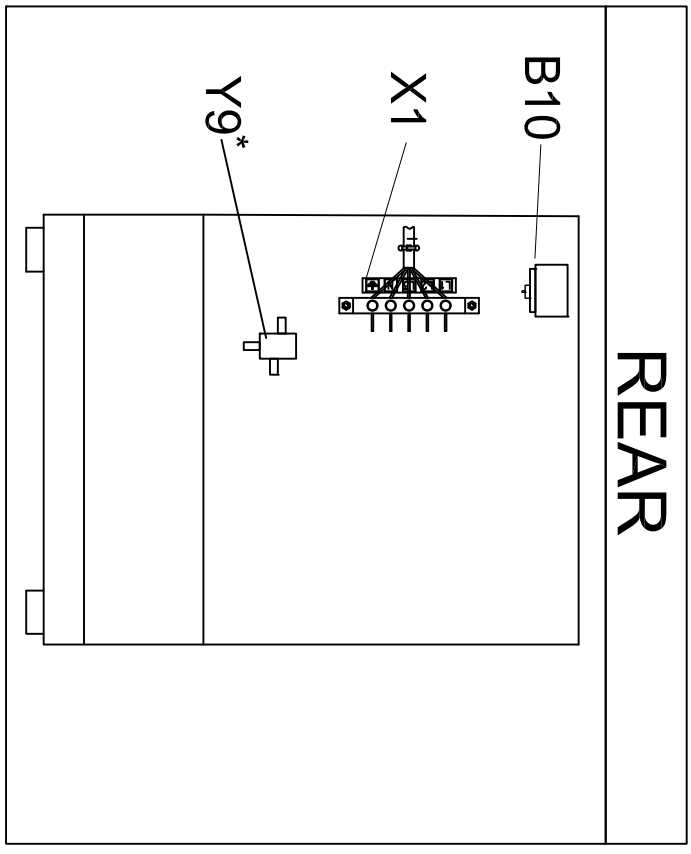

n° MODIFICA		DESCRIZIONE		SOSTITUISCE		DATA		Code	
code machine		denomination		re-examined		date		1349	
—		TOPOGRAPHIC		15/03/17		15/03/17		n° file	
Inspected by		total sheet		date		N° sheet		mod	
Bertolini		4		15/03/17		3		1349T	
Validated by		Next sheet						-1	

B2	Boiler probe	Temperaturfühler Durchlauferhitzer	Sonde surchauffeur	Sonda boiler	Palpador de temperatura calderin	Sonda de temperatura caldera
B4	Tank probe	Tanktemperaturefühler	Sonde cuve	Sonda vasca	Palpador de temperatura en la cuba	Sonda de temperatura tanque
B5	Door switch	Reed- Türsicherheitkontaktschalter	Micro contact de porte	Micro porta	Interruptor de puerta	Micro-interruptor porta
B10	Tank level control	Tankniveauschalter	Pressostat de cuve	Controllo livello vasca	Interruptor del nivel en la cuba	Interruptor de nivel tanque
B17	Tank limiting thermostat	Tank begrenzung thermostat	Thermostat de limitation de la cuve	Termostato limitatore vasca	Termostato limitador cuba	Limitador de temperatura caldera
C1	Wash pump noise filter	Fünkenstörfilter Umwälzpumpe	Condensateur pompe de lavage	Condensatore pompa lavaggio	Condensador bomba de lavado	Condensador bomba lavagem
C2	Rinse booster pump noise filt.	Fünkenstörfilter Drucksteigerungspumpe	Condensateur pompe auxiliaire	Condensatore pompa ausiliaria	Condensador bomba de aumento presion	Condensador bomba do aumento de pressão
E1	Boiler heating element	Heizkörper Durchlauferhitzer	Resistance du surchauffeur	Resistenza boiler	Resistencia del calderin	Resistências caldera
E3	Tank heating element	Tankheizung	Resistance de cuve	Resistenza vasca	Resistencia de la cuba	Resistências cuba
F1	Boiler safety thermostat	Durchlauferhitzer Temperaturbegrenzer	Thermostat securite surchauffeur	Termostato sicurezza boiler	Limitador de temperatura del calderin	Rgolador de temperatura caldera
F3	Tank safety thermostat	Tanktemperaturbegrenzer	Thermostat securite cuve	Termostato sicurezza vasca	Limitador de temperatura del deposito	Rgolador de temperatura tanque
H1	Power lamp	Netz Kontrolleuchte	Voyant reseau	Spia di linea	Lámpara de piloto alimentación	Lâmpada indicadora tenção
H3	Cycle lamp	Spülprogramm Kontrolleuchte	Voyant de cycle	Spia ciclo	Lámpara de piloto ciclo	Lâmpada indicadora ciclo
H4	Heating lamp	Heizkörper Kontrolleuchte	Voyant de chauffage	Spia riscaldamento	Lámpara de piloto calefacción	Lâmpada indicadora aquecimento
K1	Main relay	Relais EIN / AUS	Relais Marche / Arrêt	Relè di linea	Relé suministro de corriente	Relé de alimentação elétrica
K2	Boiler heating element relay	Durchlauferhitzer Heizkörper Relais	Relais resistance surchauffeur	Relè resistenza boiler	Relé resistencia Calderin	Relé de resistência de caldeira
M1	Wash pump motor	Motor Umwälzpumpe	Moteur pompe lavage	Motore pompa lavaggio	Motor bomba lavado	Motor bomba de lavagem
M3	Drain pump motor	Motor Laugenpumpe	Moteur pompe vidange	Motore pompa scarico	Motor bomba de desagüe	Motor bomba de esgoto
M6	Detergent pump motor	Dosiergerät Reiniger	Moteur pompe produit lavage	Dosatore detergente	Dosificador por el detergente	Doseador de detergente
M8	Rinse aid pump motor	Dosiergerät Glänzmittel	Moteur pompe produit de rinçage	Dosatore brillantante	Dosificador abrillantador	Doseador da solução para brilho
N3	Electronic control	Programmschaltwerk Elektronikmodul	Carte controle cycle	Scheda controllo ciclo	Electrónica de controló ciclo	Módulo electrónico temporizador de ciclo
S1	Start cycle push button	START- Taste Spülprogramm	Poussoir mise en cycle	Pulsante avvio ciclo	Pulsador de principio ciclo	Botões arranque ciclo
S3	Drain push button	Taste Laugenpumpe (Entleeren)	Poussoir pompe vidange	Pulsante pompa scarico	Pulsador bomba de desagüa	Botões bomba de esgoto
S14	Machine main switch	Umschalter Betriebs / Ruhestellung - Regenerieren	Sélecteur lavage / arrêt - regeneration	Deviatore servizio / riposo-rigenerazione	Conmutadore conex. / desconex - regeneración	Comutador arranque / interrupção-regeneração
S16	Wash time selector	Wahlschalter Spülprogrammdauer	Sélecteur durée cycle	Selettore tempi	Selector de tiempo de lavado	Manipulo para seleccionar o tempo do ciclo
Y4	Fill / hot rinse solenoid valve	Elektromagnetventil Füllen / Klarspülung warm	Electrovanne remplissage	Elettrovalvola carico / risciacquo caldo	Válvula magnética de entrada / enjuague caliente	Válvula magnética de entrada / enxague quente
Y9	Regeneration solenoid switch valve	Regenerieren Elektromagnet wechsellventil	Electrovanne échangeur régénération	Elettrovalvola scambiatrice di rigenerazione	Válvula cambiadora de regeneración	Válvula cambista de regeneração