



MOD : TS3N/HA

Production code : TEPG3V1520-DM

03/2026



REFRIGERATED COUNTERS



INSTALLATION, OPERATING AND MAINTENANCE INSTRUCTIONS

GB

The manufacturer reserves the right to modify the appliances presented in this publication without notice.

GB

1. INDEX

1. INDEX.....	1
2. ANALYTICAL INDEX.....	2
3. REGULATIONS AND GENERAL INSTRUCTIONS.....	3
3.1. General information.....	3
3.2. Warranty.....	3
3.3. Description of the Appliance.....	3
3.4. Features Plate.....	4
3.5. Replacement of Parts.....	4
4. SAFETY.....	5
5. USE AND FUNCTIONING (EVX214 VERSION).....	6
5.1. Description of Controls.....	6
5.2. Viewing the LED Display.....	7
5.3. Functions.....	8
6. USE AND FUNCTIONING (PJEZ VERSION).....	11
6.1. Description of the Controls.....	11
6.2. Functionality.....	11
7. CLEANING AND MAINTENANCE.....	12
7.1. Recommendations for Cleaning and Maintenance.....	12
7.2. Routine Maintenance.....	12
8. RECOMMENDATIONS FOR USE.....	12
8.1. Prolonged Inactivity.....	12
8.2. Recommendations for normal use.....	13
9. FAULTS.....	14
9.1. Alarms Display (EVX214 Version).....	15
9.2. Faults Display (EVX214 Version).....	15
9.3. Faults Display (PJEZ Version).....	16
10. INSTALLATION.....	16
10.1. Packaging And Unpacking.....	16
10.2. Installation.....	17
10.3. Electric Power Supply Connection.....	18
10.4. Refrigerant Attachment (Remote Version).....	18
10.5. Inspection.....	18
10.6. Reversibility of the Doors.....	19
11. DISPOSAL OF THE APPLIANCE.....	20
12. REFRIGERANT TECHNICAL CARD R134a / R452A.....	20
13. REFRIGERANT TECHNICAL CARD R290.....	20
ATTACHMENTS.....	I

2. ANALYTICAL INDEX

A

Alarms Display (EVX214 Version); 15

C

Cancelling the list of HACCP alarms; 10
Compressor operating hours; 10

D

Defrosting; 11
Description of Controls; 6
Description of the Appliance; 3
Disposal of the Appliance; 20

E

Electric Power Supply Connection; 18
Enabling / Disabling the Overcooling function; 8
Enabling manual defrost; 8
Enabling the Energy Saving function; 8
Enabling the function for high or low humidity; 8

F

FAULTS; 14
Faults Display (EVX214 Version); 15
Faults Display (PJEZ Version); 16
Features Plate; 4
Functionality; 11
Functions; 8

G

General information; 3

H

HACCP Alarms; 9
HACCP alarms display; 9

I

Inspection; 18
Installation; 17

L

Locking the keyboard; 8

P

Packaging; 16
Prolonged Inactivity; 12

R

Recommendations for Cleaning and Maintenance;
12
Recommendations for normal use; 13
Recommendations for Use; 12
REFRIGERANT TECHNICAL CARD R134a /
R452A; 20
REFRIGERANT TECHNICAL CARD R290; 20
Replacement of Parts; 4
Reversibility of the Doors; 19
Routine Maintenance; 12

S

SAFETY; 5
Setting the time and date; 8
Setting the working setpoint; 8
Setting the Working Temperature; 11
Switching the appliance On and Off; 8
Switching the cold room light On / Off; 8

U

Unpacking; 16

V

Viewing the LED Display; 7
Viewing the temperature probes; 9

W

Warranty; 3

3. REGULATIONS AND GENERAL INSTRUCTIONS

3.1. General information

This manual has been designed by the manufacturer to provide the necessary information to those who are authorised to interact with the appliance.

It is advisable for the receivers of the information to read it carefully and apply it strictly.

Reading the information contained in this document will allow the user to prevent risks to personal health and safety.

Keep this manual for the entire operating life of the appliance in a place which is well-known and easily accessible, so that it is always available when its consultation becomes necessary.

Particular symbols have been used to highlight some parts of the text that are very important or to indicate some important specifications. Their meanings are given below:



Indicates important information regarding safety. Behave appropriately so as not to risk the health and safety of persons or cause damage.



Indicates particularly important technical information that must not be ignored.

3.2. Warranty

The warranty of the appliance and the components we produce has duration of 1 (one) year from the date of delivery and translates into the supply, free of charge, of parts that we consider to be faulty.

These faults must, however, be independent from incorrect use of the product in compliance with the indications stated in the manual.

Fees deriving from labour, journeys and transport are excluded from the warranty.

The materials replaced under warranty are our property and must therefore be returned under the responsibility and expense of the customer.

3.3. Description of the Appliance

The refrigerated table, from now on defined as appliance, has been designed and built to preserve foodstuffs in the professional catering ambit.

- 1) **condensation area:** it is positioned in the right or left side and is characterised by the presence of the condensing unit.
- 2) **electric area:** it is positioned in the front part of the condensing unit and contains the control and power supply appliance as well as electric wiring.
- 3) **evaporation area:** it is situated inside the refrigerated compartment in the right or left side (ventilated) or in the rear (static) and is characterised by the evaporating unit.
- 4) **storage area:** it is situated inside the refrigerated compartment (in models with refrigerated drawer above the technical compartment also in the upper right area) and is destined for the preservation of foodstuffs.

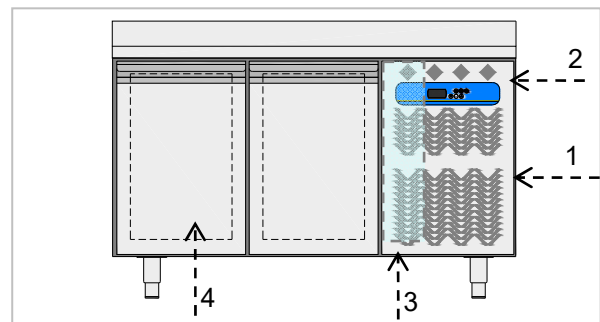

In the front part there are one or more doors or drawers, which close the refrigerated compartment hermetically.

Depending on requirements, the appliance is produced in several versions.

TN VENTILATED TABLES**(-2°C +8°C) (0°C +10°C)**

Model suitable for preservation of fresh foodstuffs, packed pre-cooked foods and beverages.

The period of preservation must be intended as quite limited.



BT VENTILATED TABLES**(-20°C -10°C)**

Model suitable for the preservation of deep-frozen products for long periods of time.

3.4. Features Plate

The identification plate shown is applied directly onto the appliance. It states the references and all indications indispensable for working in safety.

- 1) Appliance code
- 2) Description of the appliance
- 3) Serial number
- 4) Power supply voltage and frequency
- 5) Electrical absorption
- 6) Climatic class
- 7) Type and Amount of refrigerant gas
- 8) WEEE symbol

CODICE CODE /KODE		1
MODELLO MODEL/MODELL		2
MATRICOLA SERIAL No/SERIEN NR.		3
TENSIONE TENSION/SPANNUNG		4
INPUT LEISTUNGS-AUFNABME POTENZA		5
CLIMATIC CLASS KLIMAKLASSE CLASSE CLIMATICA		6
REFRIGERANT KUEHLMITTEL REFRIGERANTE		7
  		8

3.5. Replacement of Parts

Before carrying out any replacement intervention, activate all envisioned safety devices.





In particular, deactivate the electrical power supply using the differential disconnecting switch. When worn components must be replaced, only use original spare parts.





All responsibility is declined for injury to persons or damage to components deriving from the use of non-original spare parts and interventions which could modify the safety requisites, without authorisation of the manufacturer.

4. SAFETY

 It is recommended to carefully read the instructions and warnings contained in this manual before using the appliance. The information contained in the manual is fundamental for the safety of use and for machine maintenance.

 Keep this manual carefully so that it can be consulted when necessary.

 The electric plant has been designed in compliance with the IEC EN 60335-2-24 Standard.

 Specific adhesives highlight the presence of mains voltage in the proximity of areas (however protected) with risks of an electrical nature.

 Before the connection, ensure the presence of an omnipolar switch with minimum contacts opening equal to 3 mm in the mains power supply upstream from the appliance (requested for appliances supplied without plug to connect to the fixed plant).

In the design and construction phase, the manufacturer has paid particular attention to the aspects that can cause risks to safety and health of persons that interact with the appliance.

Carefully read the instructions stated in the manual and those applied directly to the machine, and particularly respect those regarding safety.

Do not tamper with, evade, eliminate or by-pass the installed safety devices. Failure to comply with this requisite can lead to serious risks for personal health and safety.

It is recommended to simulate some test manoeuvres to identify the controls, in particular those relative to switch-on and switch-off and their main functions.

The appliance is only destined for the use for which it has been designed; any other use must be considered improper.

The manufacturer declines all liability for any damage to objects or injury to persons owing to improper or incorrect use.

 All maintenance interventions that require precise technical skill or particular ability must be performed exclusively by qualified staff.

In order to guarantee hygiene and protect the foodstuffs from contamination, the elements that come into direct or indirect contact with the foodstuffs must be cleaned very well along with the surrounding areas. These operations must only be performed using detergents that can be used with foodstuffs, avoiding inflammable products or those that contain substances that are harmful to personal health.

In the case of prolonged inactivity, as well as disconnecting all the supply lines, it is necessary to accurately clean all internal and external parts of the appliance.

5. USE AND FUNCTIONING (EVX214 VERSION)



5.1. Description of Controls



ON ... OFF Key

Pressing the **ON/OFF** key makes the controller switch-on. Press the key for 2 consecutive seconds to switch off the controller.



SET Key

Pressing this once during normal operation allows you to set the working setpoint.



Defrost Key

Pressing this key once during normal operation, allows you to start manual defrost.



Light Key

Pressing this key once during normal operation, allows you to turn the light on and off.



Increase ... Decrease Key

Pressing these keys during setpoint programming, parameters and humidity increases or decreases the selected value.

5.2. Viewing the LED Display

There are a number of graphic signals within the display area.



This LED indicates the state (on or off) of the COMPRESSOR



This LED indicates the activation of the ENERGY SAVING function



This LED indicates the state (on or off) of the FAN



This LED indicates that defrosting is in progress



This LED indicates the state (on or off) of the LIGHT



This LED indicates an HACCP state of alarm.



This LED indicates the state (on or off) of the DOOR RESISTANCES



This LED indicates an HACCP state of ALARM / FAILURE.



This LED indicates the activation of the OVER COOLING function





THE LED lights require cleaning of the condenser filter.





GB

5.3. Functions



Switching the appliance On and Off

Make sure the keyboard is not locked. Hold the  key down for two seconds: the  led will turn on / off.



Setting the working setpoint

Make sure the keyboard is not locked. Press and release the  key: the  led will flash. Set the new working setpoint with  and . Confirm the new value with .

Switching the cold room light On / Off



Make sure the keyboard is not locked. Press and release the  key: the  led will turn on. To turn the light off press the  key again.

Enabling / Disabling the Overcooling function

Make sure the keyboard is not locked. Press the  button for at least 4 seconds. The  will turn on. During the Overcooling function the setpoint is increased by 1°C. During the Overcooling function defrost is never enabled.

Enabling manual defrost

Make sure that the keyboard is not locked and that the Overcooling function is not in progress.

Press the  button for at least 4 seconds. If the temperature of the evaporator probe is not greater than the set limit, the defrost function is enabled and the  led will turn on. When defrost is finished the  led will turn off.



Enabling the Energy Saving function



Once the established time is over without opening the doors, the Energy Saving function is enabled :

the  led will turn on. The function stops the first time the door is opened.



Enabling the function for high or low humidity

Make sure the keyboard is not locked. To view the current function press and release the

keys  and  : the screen displays "rhH" if the function for high percentage of humidity is enabled, "rhL" if the function for low percentage of humidity is enabled.

To change the function press the  and  keys for at least 4 seconds: the screen displays "rhH" (high percentage of humidity function) or "rhL" (low percentage of humidity function).

Locking the keyboard





To lock the keyboard press the  and  keys for at least 1 second: the screen displays "Loc" for 1 second. If the keyboard is locked, it will not be possible to perform any operation: any operation will cause the word "Loc" to appear on the display screen. To unlock the keyboard press

the  and  keys for at least 1 second: the screen will display "UnL" for 1 second.



Setting the time and date



Make sure the keyboard is not locked.



Press the  key for 1 second: the screen displays the letters "rtc".



Press and release the  key: the screen will display "yy" followed by the last two numbers of the year and the  LED will flash. With the keys  and  it is possible to set the current year.



Press the  key to memorise the date and move on to changing the month: the screen will

display "nn" followed by the two numbers of the month. With the keys  and  it is possible to set the current month.

Press the  key to memorise the date and move on to changing the day: the screen will display "dd" followed by the two numbers for the day. With the keys  and  it is possible to set the current day.

Press the  key to memorise the date and move on to changing the time: the screen will display "hh" followed by the two numbers for the hour. With the keys  and  it is possible to set the current hour.

Press the  key to memorise the entry and move on to changing the minutes: the screen will display "nn" followed by the two numbers of the minutes. The time is displayed in a 24 hour format. Using the  and  keys it is possible to set the correct value.



Press and release the  key or do not operate for 15 seconds: the  LED will turn off. To exit the procedure early press and release the  key.



Viewing the temperature probes

Make sure the keyboard is not locked.

Press the  key for 1 second: the screen displays the letters "rtc".

Press the  key: the screen will display the temperature read by the cold room probe.

Press the  key: the screen displays the letters "Pb2" (evaporator probe). Press the  key to view the value read by the evaporator probe.

Press the  key: the screen displays the letters "Pb3" (condenser probe). Press the  key to view the value read by the condenser probe.

To exit the procedure press the  key: the screen will display the temperature read by the cold room probe again.

HACCP Alarms

The tool is capable of memorising up to 9 HACCP alarms, after which the most recent alarm will over-write the old one. The tool provides the following information:

- alarm code
- the critical value
- the date and time when the alarm was set off
- the duration of the alarm (from 1 min to 99 h and 59 min, partial if the alarm is in progress).

The following alarm codes are available:

- **AL** : minimum temperature alarm
- **AH** : maximum temperature alarm
- **id** : door microswitch input alarm
- **PF** power failure alarm

 To avoid having to memorise power failure alarms repeatedly, disconnect the power supply when the tool is off

 If the duration of the power failure alarm is such that it causes a clock error (code "rtc"), the tool will not provide any information regarding the duration of the alarm



HACCP alarms display

Make sure the keyboard is not locked.

Keep the  key pressed for 1 second: the screen will display the letters "rtc".

Press the  key repeatedly until the letters "LS" appear.

Press the  key: the screen will display the code for the most recent alarm (in other words one of the codes listed above followed by number "1"; the greater the number that follows the code

for the alarm, the older it is). With the  and  keys it is possible to scan the various memorised alarms.

To select an alarm press the  key: the **HACCP** led will stop flashing and stay on steadily, the screen will display the following information in sequence :

8.0	the critical value is 8.0 °C/8 °F
StA	the screen is about to display the date and time when the alarm was set off
y09	the alarm was set off in 2009 (continue ...)
n03	the alarm was set off in the month of March (continue ...)
d26	the alarm was set off on March 26, 2009
h16	the alarm was set off at 16:00 (continue ...)
n30	the alarm was set off at 16:30 (continue ...)
dur	the screen will display the duration of the alarm
h01	the alarm lasted for 1 h (continue ...)
n15	the alarm lasted for 1 h and 15 min
AH3	the selected alarm

The screen displays every piece of information for 1 second.

To exit the sequence of information: press and

release the  key, the screen displays the selected alarm ("**AH3**" in the example).

To exit the procedure press the  key: the screen will display the temperature read by the cold room probe again.

 If the tool does not have any alarms in its memory, the "**LS**" label will not be displayed.

Cancelling the list of HACCP alarms

Make sure the keyboard is not locked.

Keep the  key pressed for 1 second: the screen will display the letters "**rtc**".

Press the  key repeatedly until the letters "**rLS**" appear.

Press the  key: the password will be requested in order to cancel the alarms from the memory.

With the  and  keys enter the

password **149** : press the  key to confirm the deletion of the alarms.

 If the tool does not have any alarms in its memory, the "**rLS**" label will not be displayed.

Compressor operating hours

The tool is capable of memorising up to 9,999 hours of compressor operation, after which the number "9999" will flash.

To view the hours of compressor operation follow the instructions below.

Make sure the keyboard is not locked.

Keep the  key pressed for 1 second: the screen will display the letters "**rtc**".

Press the  key repeatedly until the letters "**CH**" appear.

Press the  key to view the data. To reset the counter to zero follow the instructions below.

Make sure the keyboard is not locked.

Keep the  key pressed for 1 second: the screen will display the letters "**rtc**".

Press the  key repeatedly until the letters "**rCH**" appear.

Press the  key: the password is required in order to reset the counter to zero.

With the  and  keys enter the

password **149** : press the  key to confirm.

GB

6. USE AND FUNCTIONING (PJEZ VERSION)

6.1. Description of the Controls

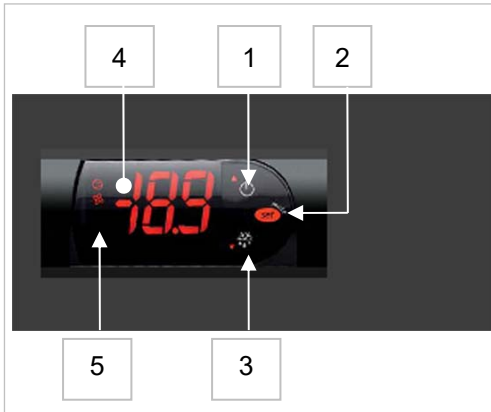

1. Remote-thermostat ON/OFF key
 2. Setpoint setting key
 3. Manual defrosting start key
 4. Digital remote-thermostat
 5. Functioning status LED
- 1-2-3 Temperature modification keys



6.2. Functionality



Switching the Remote-thermostat On and Off

Switching the instrument on (ON): press the following key for a few seconds  (when the key is pressed the display shows ON).

Switching the instrument off (OFF): press this key for three seconds . Switch-off is confirmed by "OFF" alternating with the temperature measured by the set probe shown on the display.

Setting the Working Temperature

The temperature set during the factory inspection is highlighted by pressing this button . This temperature remains on the display for 5 seconds during which it can be modified by acting on  and , which respectively indicate the increase or decrease of the same.

After 5 seconds that the  and  keys are not pressed, the temperature of the refrigerated compartment is displayed again. The internal temperature of the compartment can be set by the user between the maximum and minimum level, highlighted in the top part of the door.

Defrosting

The digital remote-thermostat automatically controls defrosting of the evaporator. Defrosting is indicated by the relevant LED.

During this phase it is recommended not to load or unload the refrigerated compartment. The end of defrosting is piloted by the relevant probe.

In particularly hard working conditions (high environmental temperatures and humidity or following the introduction of substances with high humidity transfer) it is recommended to perform

additional manual defrosting operations, by acting for a few seconds on the  key.



LED Display

There are graphic signals within the display area:



This LED indicates the state (on or off) of the COMPRESSOR



This LED indicates the state (on or off) of the FAN

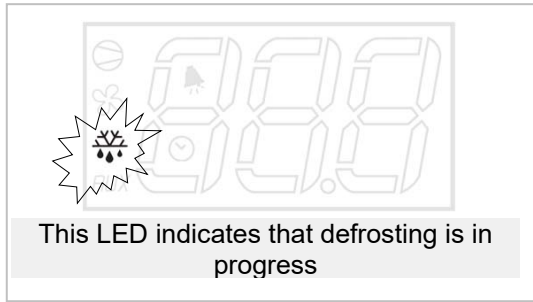

7. CLEANING AND MAINTENANCE

7.1. Recommendations for Cleaning and Maintenance



Before carrying out any maintenance intervention, activate all envisioned safety devices. In particular, deactivate the electrical

power supply using the automatic disconnecting switch.

7.2. Routine Maintenance

Routine maintenance consists of daily cleaning of all the parts which can come into contact with foodstuffs and the periodic maintenance of the burners, nozzles and draining pipes. Correct maintenance allows the user to maximise performance levels and operating life and constantly maintain safety requirements.

Do not spray the appliance with direct jets of water or high pressure appliances.

When cleaning stainless steel, do not use iron wool, brushes or scrapers as ferrous particles could be deposited which, on oxidising, could lead to rust.

To remove hardened residues, use wooden or plastic spatulas or abrasive rubber pads.

During long periods of inactivity, spread a protective layer on all stainless steel surfaces by wiping them with a cloth soaked in Vaseline oil and airing the rooms periodically.



Do not use products which contain substances which are harmful and dangerous for personal health (solvents, petrol etc.).

Periodically have the following operations carried out by specialised staff:

- Periodically clean the condenser using suitable tools (suction device or soft brushes).
- Check the perfect sealing of the door gaskets and replace them if necessary.
- Periodically clean the condensate evaporation tray.
- Check that the electric connections have not loosened.
- Check the efficiency of the heating element (in BT models).
- Check functioning of the remote-thermostat or cards and probes.
- Check the efficiency of the electrical system.

8. RECOMMENDATIONS FOR USE

8.1. Prolonged Inactivity

If the appliance remains inactive for a long period, proceed as follows:

1. Use the automatic disconnecting switch to deactivate connection to the main electrical line.
2. Clean the appliance and surrounding areas thoroughly;
3. Spread a thin layer of cooking oil onto the stainless steel surfaces;
4. Carry out all maintenance operations;
5. Leave the doors ajar to prevent the formation of mould and/or unpleasant odours.

8.2. Recommendations for normal use









In order to ensure correct use of the appliance, it is advisable to apply the following recommendations:

- Do not obstruct the zone in front of the condensing unit in order to favour heat disposal from the condenser to a maximum.
- Always keep the front of the condenser clean using a soft brush and do not use rigid or metal tools that may damage the condenser fins.
- Check the planarity of the appliance rest surface.
- Do not introduce liquid or solid substances at temperatures above the environmental temperature and, however, introduce the material after the appliance has reached the functioning temperature.
- Do not stack the materials to be preserved in contact with the internal walls, so blocking the circulation of air, which guarantees uniformity of the internal temperature of the refrigerated compartment.
- Limit the number of times and the duration of time the doors are open to a maximum.





9. FAULTS

The information shown below aims to help with the identification and correction of any anomalies and malfunctions which could occur during use. Some of these problems can be resolved by the

user. For the others, precise competency is required and they must therefore only be carried out by qualified staff.

Problem	Causes	Solutions
The refrigerator unit does not start	End of defrosting	it starts after a pause of 3 minutes
	Switch-off by means of master switch	re-started, starts up after 3 minutes
	No voltage	check plug, sockets, fuses and electric mains
	Other causes	 If the problem persists, contact the after-sales centre.
The refrigerator unit functions continuously, cooling insufficiently	Room too hot	air the environment
	Dirty condenser	clean the condenser
	Insufficient door sealing	check the gaskets
	Insufficient quantity of refrigerant gas	 Contact the after-sales centre.
	Hot gas valve partially open	 Contact the after-sales centre.
	Resistances always inserted	check timer (only on models with electric defrosting)
	Condenser fan at a standstill	 Contact the after-sales centre.
	Evaporator fan at a standstill	 Contact the after-sales centre.
The refrigerator unit does not stop	Probe faulty	 Contact the after-sales centre.
	Remote-thermostat or thermostat faulty	 Contact the after-sales centre.
Presence of ice inside the evaporator	Drain pipe blocked	disassemble and re-assemble the drain unit after having checked its cleanliness
	Appliance not level	use the adjustable feet to level
	Hot gas valve failure	 Contact the after-sales centre.
	Resistances not functioning	check defrosting activation (only on models with electric defrosting)
Appliance noise	Persistent vibrations	check there is no contact between the appliance and other objects inside or outside

9.1. Alarms Display (EVX214 Version)

Problem	Causes	Solutions
"AL" flashes on the display and the buzzer emits an intermittent noise (low evaporator temperature alarm)	The temperature detected by the evaporator probe is lower than the established value.	 Contact the after-sales centre. <ul style="list-style-type: none"> ➤ Make sure the evaporator fan is operating. ➤ Make sure the system is not discharged.
"AH" flashes on the display and the buzzer emits an intermittent noise (high cold room temperature alarm)	The temperature detected by the cold room probe is higher than the established value.	<ul style="list-style-type: none"> ➤ Check the cold room temperature ➤ Make sure the system is operating correctly.
"PF" flashes on the display and the buzzer emits an intermittent noise (electrical power supply failure alarm)	There has been a power failure.	<ul style="list-style-type: none"> ➤ Check the electrical system.  To avoid having to memorise power failure alarms repeatedly, turn the tool off before disconnecting the power supply.
"COH" flashes on the display and the buzzer emits an intermittent noise (condenser temperature alarm)	The temperature detected by the condenser probe is higher than the established value.	 Contact the after-sales centre. <ul style="list-style-type: none"> ➤ Air the environment. ➤ Clean the condenser.
"CSd" flashes on the display and the buzzer emits an intermittent noise (condenser fan blocked alarm)	The temperature detected by the condenser probe is higher than the established value.	 Contact the after-sales centre. <ul style="list-style-type: none"> ➤ Clean the condenser. ➤ Check that the condenser fans are functioning correctly.

9.2. Faults Display (EVX214 Version)

Problem	Causes	Solutions
"Pr1" flashes on the display and the buzzer emits an intermittent noise (cold room probe error)	<ul style="list-style-type: none"> ➤ The wrong type of probe is installed. ➤ The probe is faulty. ➤ The probe – circuit board connection is incorrect. ➤ The temperature detected by the probe is out of the limits accepted by the cold room probe in use 	 Contact the after-sales centre. <ul style="list-style-type: none"> ➤ Check that the cold room probe is the NTC type. ➤ Check the integrity of the cold room probe. ➤ Check correctness of the instrument - probe connection. ➤ Check that the temperature in proximity of the cold room probe is not out of the accepted limits
"Pr2" flashes on the display and the buzzer emits an intermittent noise (evaporator probe error)		
"Pr3" flashes on the display and the buzzer emits an intermittent noise (condenser probe error)		
The letters "rtc" (clock error) will flash on the screen	The current time setting has been deleted.	<ul style="list-style-type: none"> ➤ Set the day and time.

9.3. Faults Display (PJEZ Version)

Signals/Alarms	Causes
E0: Adjustment probe error	Probe used not compatible with instrument used
	probe cable interrupted or in short circuit
	sensor faulty
E1: Evaporator probe error	Probe used not compatible with instrument used
	probe cable interrupted or in short circuit
	sensor faulty

10. INSTALLATION

10.1. Packaging And Unpacking

Move and install the appliance respecting the information provided by the manufacturer, shown directly on the packaging, on the appliance and in this manual.

The lifting and transportation system of the packaged product envisages the use of a fork-lift truck or a pallet stacker, using which particular attention must be paid to balancing the weight in order to prevent the risk of overturning (avoid excessive tilting!).



ATTENTION: When inserting the lifting device, pay attention to the gas supply pipe and the position of the feet.

The packaging is made of cardboard and the pallet of wood. A series of symbols is printed on the cardboard packaging which highlights, in accordance with international standards, the provisions which the appliances must be subject to during loading, unloading, transportation and storage.

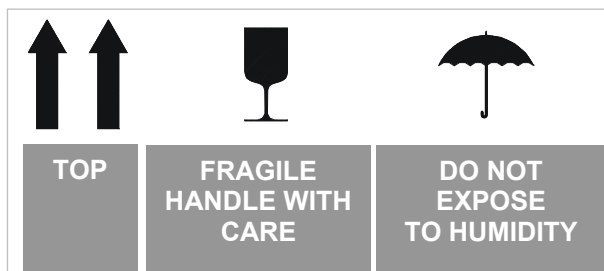

On delivery, check that the packaging is intact and has not suffered any damage during transportation.

Any damage must be notified to the transportation company immediately.

The appliance must be unpacked as soon as possible to check that it is intact and undamaged. Do not cut the cardboard with sharp tools in order to prevent damage to the steel panels underneath.

Pull the cardboard packaging upwards.

After having unpacked the appliance, check that the features correspond to those requested in the order;

For any anomalies, connect the dealer immediately.



Packaging elements (nylon bags, polystyrene foam, staples ...) must not be left within reach of children.

Remove the protective PVC film from the internal and external walls, avoiding the use of metal tools.



STACKING LIMITS: Both during transport and storage the stacking limit of the appliances is equal to a maximum of 3.

10.2. Installation

All the installation phases must be considered, from the moment of creation of the general plan. The installation area must be equipped with all power supply and production residue drainage connections and must be suitably lit and respect current laws regarding hygiene and sanitary requirements.

To optimise consumption and reduce wear of the machine, do not position it in the vicinity of heat sources or in environments where temperatures are too high.

Proceed with machine levelling, adjusting the individual feet.



This appliance can only be installed and operate in rooms which are permanently ventilated, in order to guarantee correct operation.



Connect and leave for a certain period of time (at least 2 hours) before checking functioning. During transport it is probable that the compressor lubricant oil has entered the refrigerant circuit blocking the capillary: as a consequence the appliance will function for a certain period of time without producing cold until the oil has returned to the compressor.



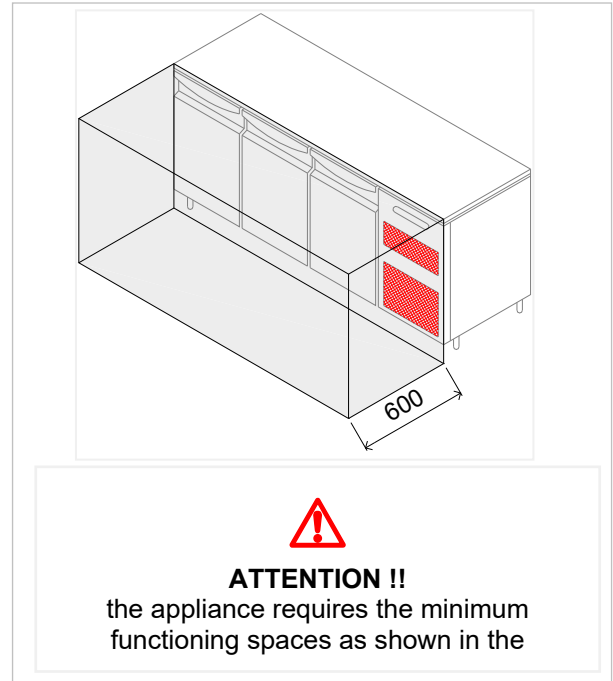

ATTENTION: the appliance requires the minimum functioning spaces as shown in the diagram.



10.3. Electric Power Supply Connection

Connection must be carried out by authorised and qualified staff, respecting the current laws regarding the subject and using appropriate prescribed material.

 Before connecting the appliance to the electric mains check that the voltage and the frequency correspond to the data stated on the registration plate applied on the rear of the appliance.

 The appliance is supplied with an operating voltage of 230V 1+N~ 50 50Hz. On request, it is

possible to have appliances with different voltages.

 Before connection, ensure the presence of a relevant differential switch with adequate power in the mains power supply, upstream from the appliance, in order to protect the appliance from overloads or short circuits

10.4. Refrigerant Attachment (Remote Version)

The "remote" condensing unit connection must be carried out according to the attached refrigerator lay-out.

Remember that the following are present in the technical compartment:

- Intake pipe.
- Liquid delivery pipe.

These are therefore connected with the corresponding types present in the condensing unit.

When the connection has been made, carefully empty and then load paying attention to use a type of refrigerant gas that is compatible with the components present.

For the start-up of the appliance, carry out electric connections between the instruments present on the control panel and condenser unit according to the attached wiring diagram.

10.5. Inspection

The appliance is delivered in conditions that it can be started-up by the user.

This functionality is guaranteed by passing the tests (electric inspection - functional inspection,

appearance inspection) and relative certification through the specific attachments.

10.6. Reversibility of the Doors

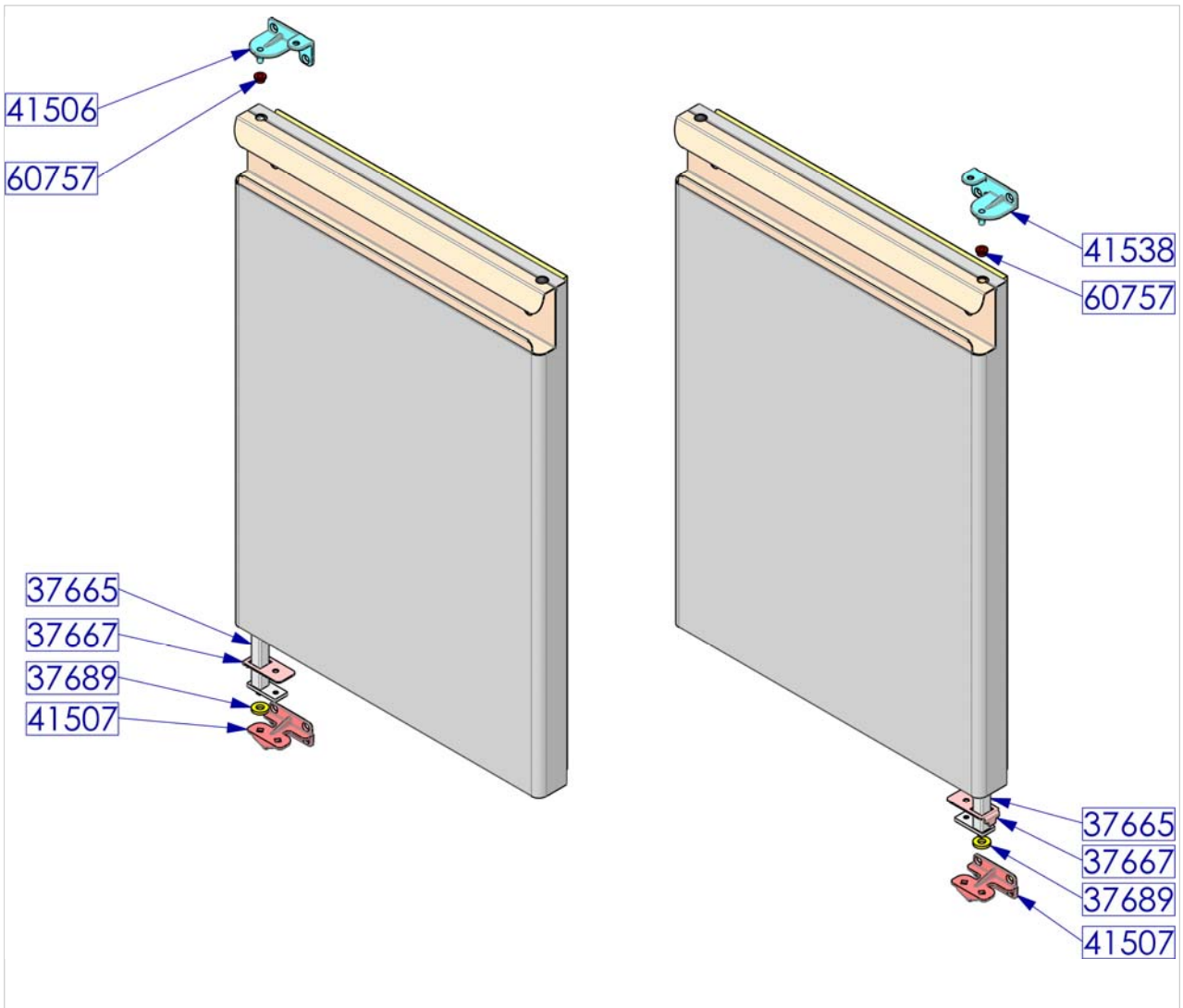

GB

11. DISPOSAL OF THE APPLIANCE

 This appliance is marked in compliance with the 2002/96/EC European Directive, WASTE ELECTRICAL AND ELECTRONIC EQUIPMENT (WEEE).

 By assuring that this product is disposed of correctly, the user contributes to preventing the potential negative consequences on the environment and health.



The symbol found on the product or on the accompanying documentation indicates

that this product must not be treated as domestic waste but must be taken to suitable collection points for the recycling of electric and electronic appliances.

Dispose of it following local regulations regarding waste disposal.

For further information regarding the treatment, recovery and recycling of this product, contact the relevant local office, the domestic waste collection service or the shop where the product was purchased.

12. REFRIGERANT TECHNICAL CARD R134a / R452A

Below find the components of the fluid:R452A

- HFC-125 59%
- HFC-1234yf 30%
- HFC-32 11%

IDENTIFICATION OF DANGERS

The rapid evaporation of the liquid can cause freezing. The inhalation of high concentrations of vapour can cause irregular heartbeat, short term narcotic effects (including vertigo, headache and mental confusion), fainting and death.

- Effects to the eyes: Freezing or cold burns caused by contact with the liquid.
- Effects on the skin: Freezing or cold burns caused by contact with the liquid.
- Effects of ingestion. Ingestion is not considered a means of exposure

FIRST AID

Eyes: In the case of contact, wash the eye well using a large amount of water for at least 15 minutes. Consult a doctor.

Effects on the skin: Wash with water for at least 15 minutes after excessive contact. If necessary, cure freezing by gently warming the area in question. Consult a doctor in the case of irritation.

Ingestion: Ingestion is not considered a means of exposure.

Inhalation: If large concentrations are inhaled, go into the open air. Keep the person calm. If the person cannot breath, perform artificial respiration. If respiration is difficult, apply oxygen. Consult a doctor.

13. REFRIGERANT TECHNICAL CARD R290

IDENTIFICATION OF DANGERS

- Extremely flammable
- Liquefied gas

FIRST AID

Eyes: In the case of contact, wash the eye well using a large amount of water for at least 15 minutes. Consult a doctor.

Effects on the skin: Wash with water for at least 15 minutes after excessive contact. If necessary, cure

freezing by gently warming the area in question. Consult a doctor in the case of irritation.

Ingestion: Ingestion is not considered a means of exposure.

Inhalation: If large concentrations are inhaled, go into the open air. Keep the person calm. If the person cannot breath, perform artificial respiration. If respiration is difficult, apply oxygen. Consult a doctor.

CIRCUITO FRIGORIFERO PER TAVOLI REFRIGERATI PREDISPOSTI
 REFRIGERATING CYCLE DIAGRAM FOR REMOTE REFRIGERATING TABLES
 SCHEMA DU CYCLE DE REFRIGERATION - TABLES REFRIGEREES SANS COMPRESSEUR
 KÜHLSCHHEMA FÜR KÜHLTISCHE OHNE AGGREGAT

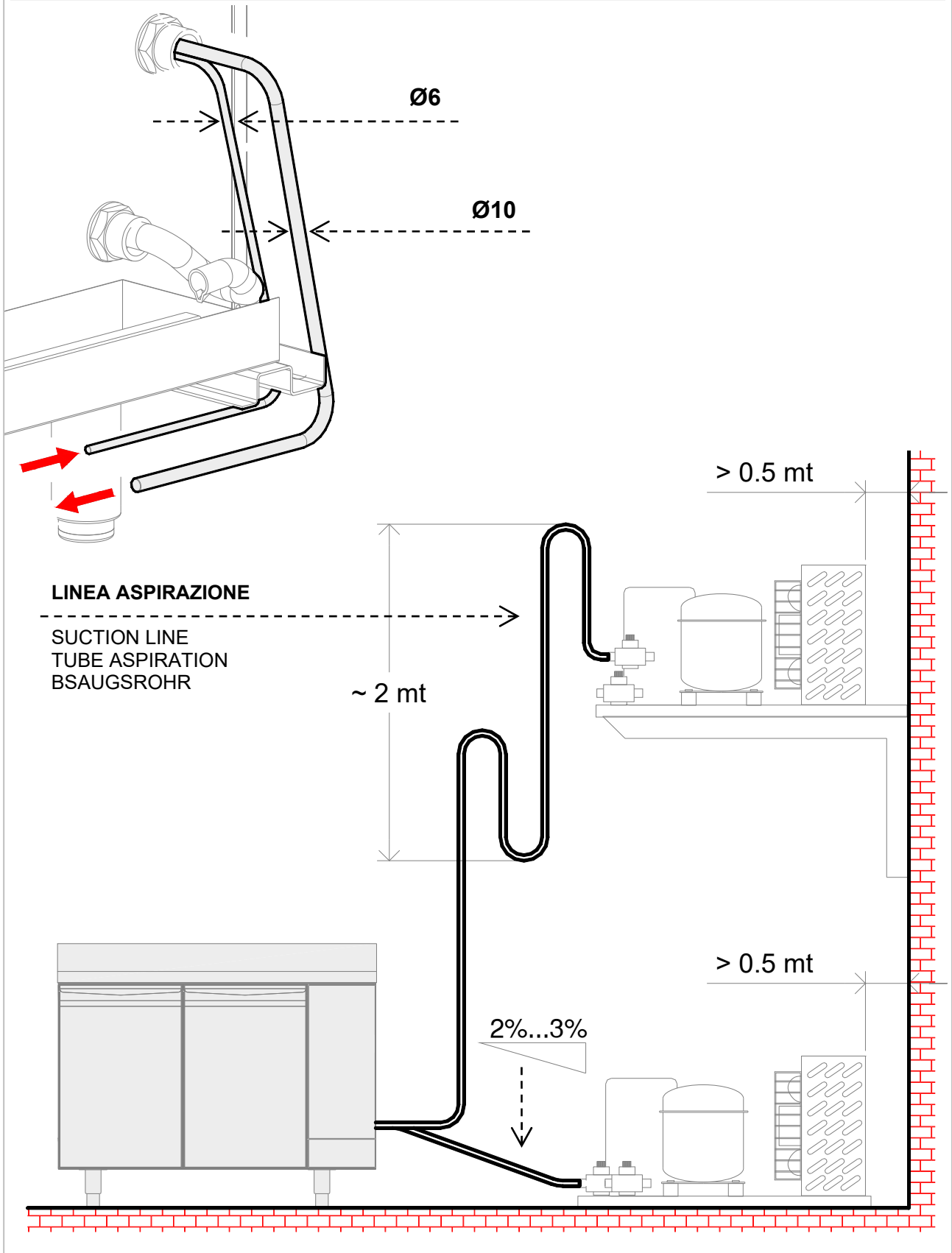

CIRCUITO FRIGORIFERO PER TAVOLI REFRIGERATI PREDISPOSTI
 REFRIGERATING CYCLE DIAGRAM FOR REMOTE REFRIGERATING TABLES
 SCHEMA DU CYCLE DE REFRIGERATION - TABLES REFRIGEREES SANS COMPRESSEUR
 KÜHLSCHHEMA FÜR KÜHLTISCHE OHNE AGGREGAT

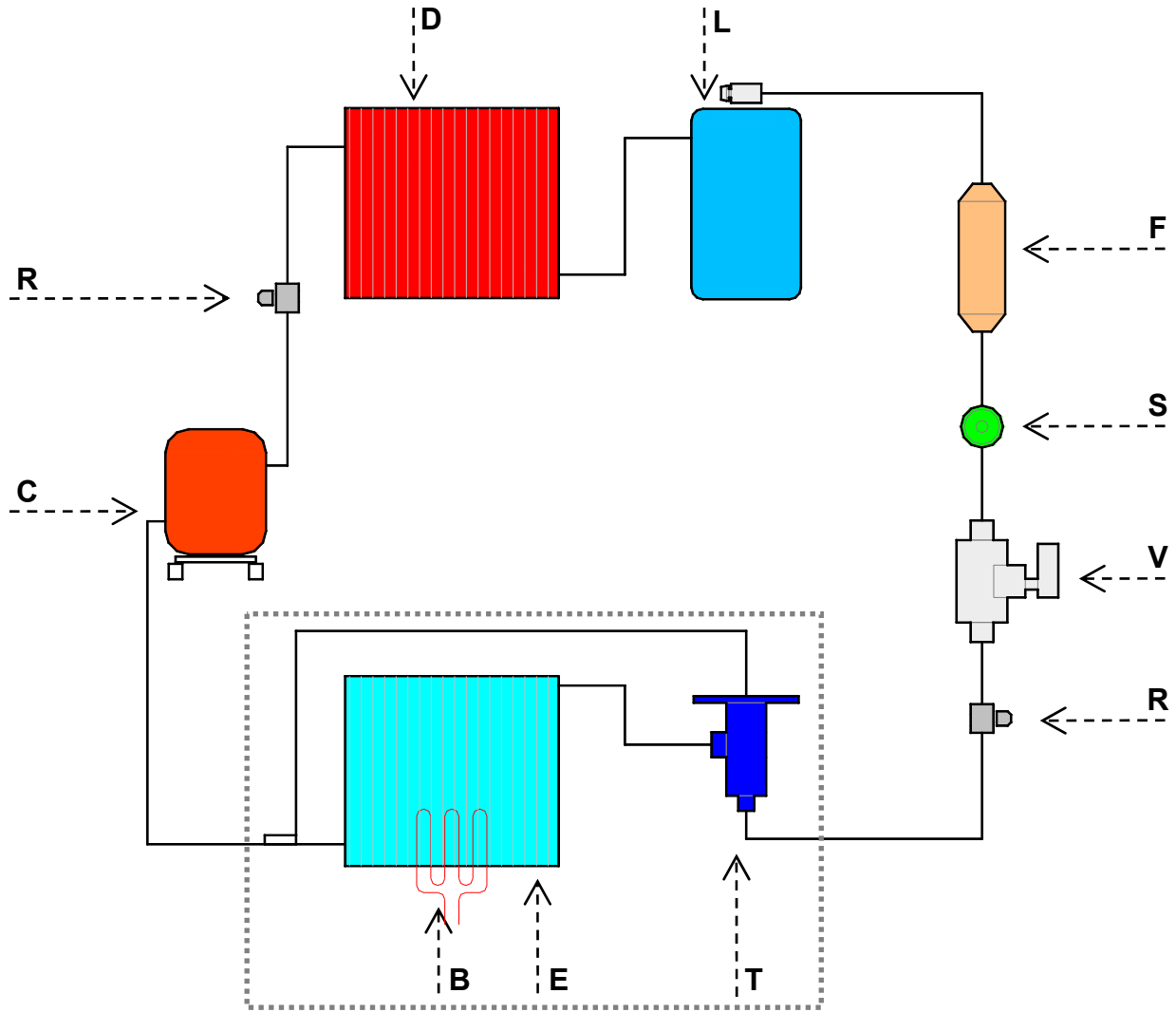

	IT	GB	FR	DE	ES
C	Compressore	Compressor	Compresseur	Kompressor	
R	Rubinetto	Cock	Robinet	Hahn	
D	Condensatore	Condenser	Condenseur	Kondensator	
L	Ricevitore di liquido	Liquid receiver	Collecteur de liquide	Flüssigkeitsempfänger	
F	Filtro deidratatore	Dehydrating filter	Filtre déshydrater	Feuchtigkeitseutzugsfilter	
S	Spia liquido	Liquid pilot light	Témoin de liquide	Kontrolleuchte Flüssigkeit	
V	Valvola solenoide	Solenoid valve	Vanne solénoïde	Solenoidventilator	
T	Valvola d'espansione	Expansion valve	Vanne d'expansion	Ausdehnungsventil	
E	Evaporatore	Evaporator-cooler unit	Evaporateur	Verdampfungseinheit	
B	Resistenza Sbrinamento	Defrosting resistance	Resistance dégivrages	Abtauungswiderstand	

	IT	EN	FR	DE	ES
C	Compressore	Compressor	Compresseur	Kompressor	
IG	Interruttore Generale	On/off switch	Interrupteur général	Hauptschalter	
SC	Sonda Cella	Room probe	Sonde cellule	Fuhler raum	
SE	Sonda Evaporatore	Evaporator Probe	Sonde évaporateur	Fuhler verdampfer	
S3	Sonda Condensatore	Condenser Probe	Sonde Condensateur	Kerntemperaturfühler	
VC	Ventilatore Condensatore	Condenser Fan	Ventilateur condenseur	Kondensatorventilator	
VE	Ventilatore Evaporatore	Evaporator fan	Ventilateur évaporateur	Verdampferventilator	
VS	Valvola solenoide (gas caldo)	Solenoid valve	Vanne solénoïde	Solenoidventil	
VA	Ventilatore vano tecnico (solo versione predisposta)	Fan (remote refrigeration units model only)	Fan (seulement modèles sans groupe logé)	Fan (nur bei Modellen für Zentralkühlung)	
RSC	Resistenza Scarico	Discharge resistance	Resistance évacuation	Abfluss-widerstand	
RST	Resistenza Stipite	Anti-condensation element	Resistance montant	Widerstand turpfasten	
IRH	On/Off umidità	On/Off humidity	On/Off humidité	EIN/AUS Feuchtigkeit	
REV	Resistenza evapora condensa (solo versione predisposta)	Condensate evaporation heater (remote refrigeration units model only)	Résistance évaporation condensation (seulement modèles sans groupe logé)	Heizelement zur Tauwasserverdunstung (nur bei Modellen für Zentralkühlung)	
RSB	Resistenza Sbrinamento	Defrosting resistance	Resistance dégivrage	Abtauungswiderstand	
PT	Protezione Termica	Safety Thermostat	Thermostate de sur	Sicherheitsthermostat	