



MOD : LFD-18L

Production code : P010215DIA

Jet engine compressor drawings

03/2026

Forno elettrico per pizza - ricambi

Electric pizza oven - spare parts • Elektrischer Ofen für Pizza - Ersatzteile • Four électrique à pizza - pièces détachées

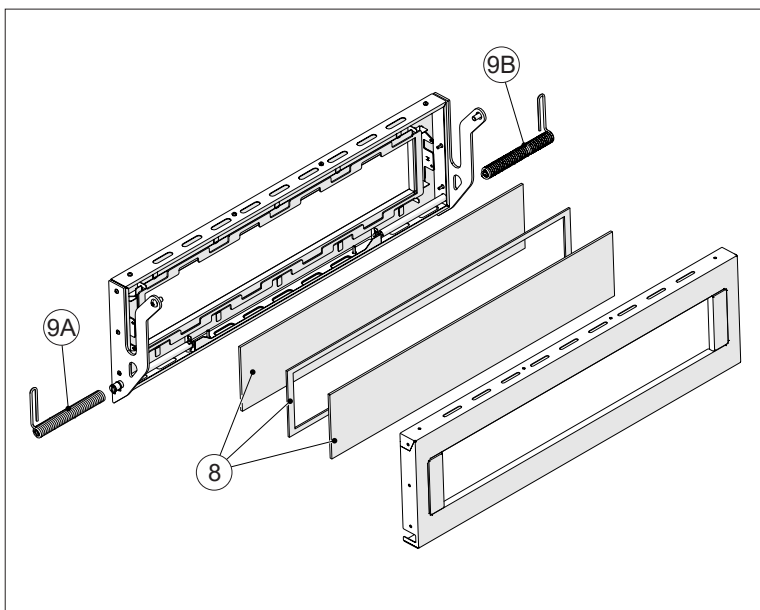
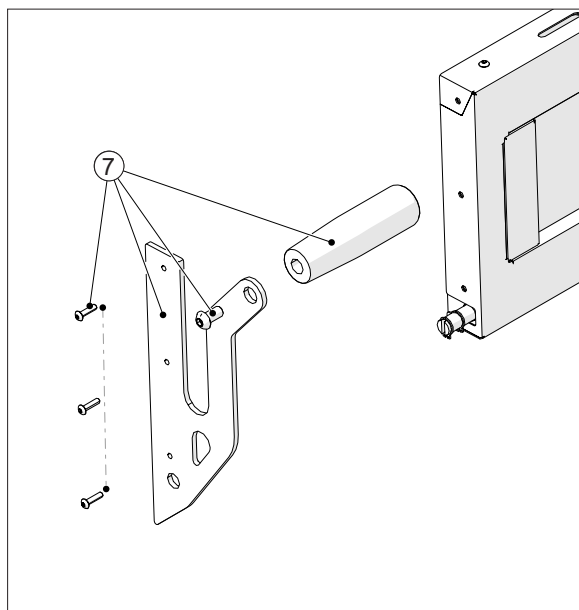
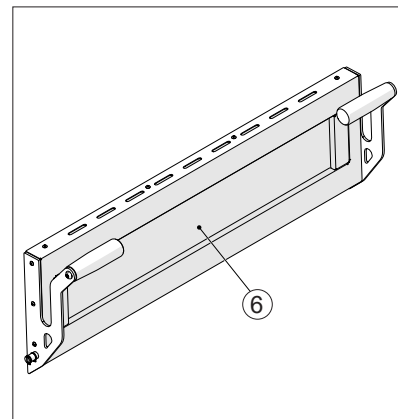
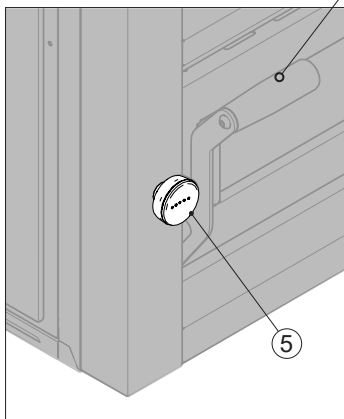
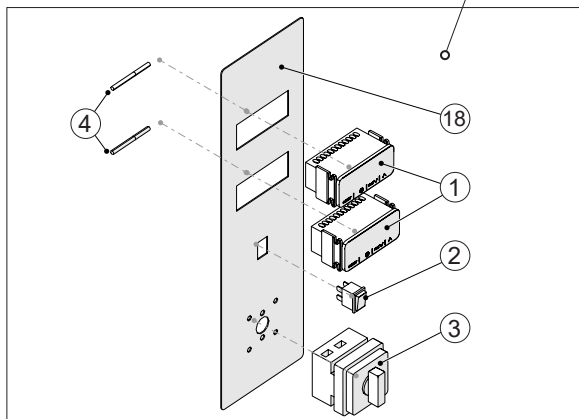
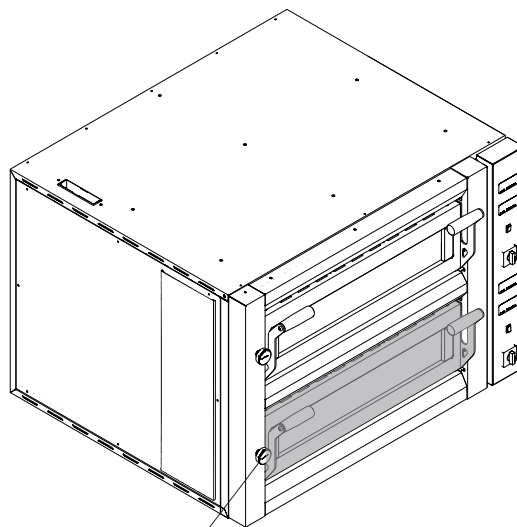
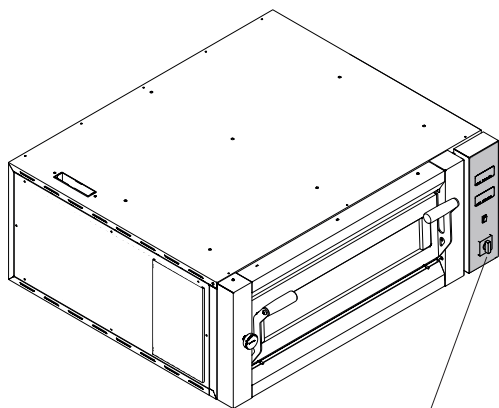

Forno elettrico per pizza - ricambi

Electric pizza oven - spare parts • Elektrischer Ofen für Pizza - Ersatzteile • Four électrique à pizza - pièces détachées

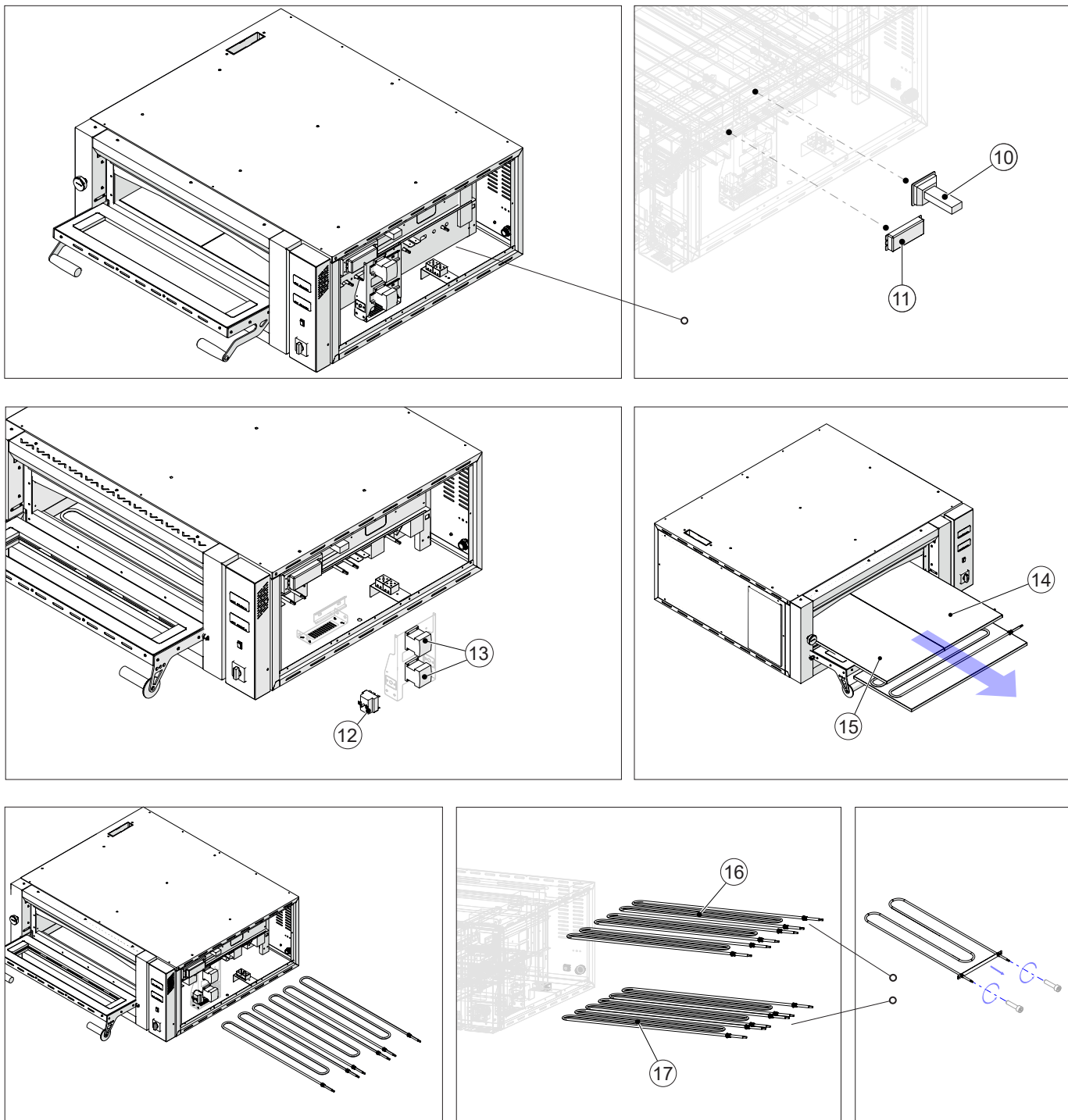

Forno elettrico per pizza - ricambi

Electric pizza oven - spare parts • Elektrischer Ofen für Pizza - Ersatzteile • Four électrique à pizza - pièces détachées

CAMERA SINGOLA

SINGLE DECK, EINZELZIMMER, MONO CHAMBRE



LFD-04

LFD-06

LFD-06L

LFD-09L

	DESCRIZIONE <i>Description, Beschreibung</i>	CODICE <i>Code, Kode</i>	QUANTITÀ <i>Quantity, Anzahl, Quantité</i>			
			LFD-04	LFD-06	LFD-06L	LFD-09L
1	Termostato digitale <i>Digital thermostat, Digitaler Thermostat, Thermostat numérique</i>	R9000011	2	2	2	2
2	Interruttore luce camera <i>Chamber light switch, Interrupteur d'éclairage de la chambre, Kammerlichtschalter</i>	R9000019	1	1	1	1
3	Interruttore generale <i>Main switch, Hauptschalter, Interrupteur général</i>	R9000026	1	1	-	-
		R9000027	-	-	1	1
4	Sonda temperatura <i>Temperature probe, Temperaturfühler, Sonde de température</i>	R9000012	2	2	2	2
5	Manopola regolazione fumi <i>Knob for fume control, Knopf Rauchauslass, Bouton pour régulation de la fumée</i>	R9000072	1	1	1	1
6	Porta completa <i>Complete door, Komplett Tür, Porte complète</i>	R9000034	1	1	-	-
		R9000035	-	-	1	1
7	Kit maniglia porta (dx e/o sx) <i>Door handle kit (right and/or left), Türgriff-Kit (rechts und/oder links), Ensemble poignée de porte (droite et/ou gauche)</i>	R9000036	2	2	2	2
8	Vetro porta + guarnizione <i>Door glass + gasket, Türglas + Dichtung, Vitre de porte + joint</i>	R9000037	1	1	-	-
		R9000038	-	-	1	1
9A	Kit molla porta sx <i>Left door spring kit, Federsatz für linke Tür, Ensemble ressort de porte gauche</i>	R9000039	1	1	1	1
9B	Kit molla porta dx <i>Right door spring kit, Federsatz für rechts Tür, Kit ressort de porte droite</i>	R9000040	1	1	1	1
10	Kit lampada a led <i>LED lamp kit, LED-Lampensatz, Ensemble de lampes à LED</i>	R9000021	1	2	1	2
11	Alimentatore per lampada a led <i>Power supply for LED lamp, Netzteil für LED-Lampe, Alimentation pour lampe LED</i>	R9000022	1	1	1	1
12	Termostato di sicurezza <i>Safety thermostat, Sicherheitsthermostat, Thermostat de sécurité - fino a matricola up to the serial number bis zur Seriennummer jusqu'au numéro de série 25009217000</i>	R9000013	1	1	1	1
12	Termostato di sicurezza <i>Safety thermostat, Sicherheitsthermostat, Thermostat de sécurité - da matricola from the serial number aus der Seriennummer à partir du numéro de série 25009217001</i>	R9000014	1	1	1	1
13	Contattore <i>Contacteur, Schütz, Contacteur</i>	R9000028	2	2	2	2
14	Kit pietra refrattaria superiore <i>Top refractory stone kit, Top-Feuerfeststein-Bausatz, Kit de pierres réfractaires supérieures</i>	R9000067	1	-	2	-
		R9000068	-	1	-	2

Forno elettrico per pizza - ricambi

Electric pizza oven - spare parts • Elektrischer Ofen für Pizza - Ersatzteile • Four électrique à pizza - pièces détachées

CAMERA SINGOLA

SINGLE DECK, EINZELZIMMER, MONO CHAMBRE



LFD-04

LFD-06

LFD-06L

LFD-09L

	DESCRIZIONE <i>Description, Beschreibung</i>	CODICE <i>Code, Kode</i>	QUANTITÀ <i>Quantity, Anzahl, Quantité</i>			
			LFD-04	LFD-06	LFD-06L	LFD-09L
15	Kit pietra refrattaria inferiore <i>Bottom refractory stone kit, Unterer Feuerfeststein-Bausatz, Kit de pierres réfractaires inférieures</i>	R9000067	1	2	-	-
		R9000068	-	-	1	2
16	Resistenza superiore <i>Upper heating element, Oberes Heizelement, Élément chauffant supérieur</i>	R9000005	3	-	-	-
		R9000006	-	3	-	-
		R9000004	-	-	6	8
17	Resistenza inferiore <i>Lower heating element, Unteres Heizelement, Élément chauffant inférieur</i>	R9000005	1	-	-	-
		R9000007	2	-	-	-
		R9000002	-	3	-	-
		R9000004	-	-	2	3
		R9000003	-	-	4	5
18	Maschera adesiva <i>Adhesive label, Étiquette adhésive, Klebeetikett</i>	R9000054	1	1	1	1

CAMERA DOPPIA

DOUBLE DECK, DOPPELKAMMER, DOUBLE CHAMBRE



LFD-08

LFD-12

LFD-12L

LFD-18L

	DESCRIZIONE <i>Description, Beschreibung</i>	CODICE <i>Code, Kode</i>	QUANTITÀ <i>Quantity, Anzahl, Quantité</i>			
			LFD-08	LFD-12	LFD-12L	LFD-18L
1	Termostato digitale <i>Digital thermostat, Digitaler Thermostat, Thermostat numérique</i>	R9000011	4	4	4	4
2	Interruttore luce camera <i>Chamber light switch, Interrupteur d'éclairage de la chambre, Kammerlichtschalter</i>	R9000019	2	2	2	2
3	Interruttore generale <i>Main switch, Hauptschalter, Interrupteur général</i>	R9000026	2	2	-	-
		R9000027	-	-	2	2
4	Sonda temperatura <i>Temperature probe, Temperaturfühler, Sonde de température</i>	R9000012	4	4	4	4
5	Manopola regolazione fumi <i>Knob for fume control, Knopf Rauchauslass, Bouton pour régulation de la fumée</i>	R9000072	2	2	2	2
6	Porta completa <i>Complete door, Komplett Tür, Porte complète</i>	R9000034	2	2	-	-
		R9000035	-	-	2	2
7	Kit maniglia porta (dx e/o sx) <i>Door handle kit (right and/or left), TürgriffKit (rechts und/oder links), Ensemble poignée de porte (droite et/ou gauche)</i>	R9000036	4	4	4	4

Forno elettrico per pizza - ricambi

Electric pizza oven - spare parts • Elektrischer Ofen für Pizza - Ersatzteile • Four électrique à pizza - pièces détachées

CAMERA DOPPIA

DOUBLE DECK, DOPPELKAMMER, DOUBLE CHAMBRE



LFD-08

LFD-12

LFD-12L

LFD-18L

	DESCRIZIONE <i>Description, Beschreibung</i>	CODICE <i>Code, Kode</i>	QUANTITÀ <i>Quantity, Anzahl, Quantité</i>			
			LFD-08	LFD-12	LFD-12L	LFD-18L
8	Vetro porta + guarnizione <i>Door glass + gasket, Türglas + Dichtung, Vitre de porte + joint</i>	R9000037	2	2	-	-
		R9000038	-	-	2	2
9A	Kit molla porta sx <i>Left door spring kit, Federsatz für linke Tür, Ensemble ressort de porte gauche</i>	R9000039	2	2	2	2
9B	Kit molla porta dx <i>Right door spring kit, Federsatz für rechts Tür, Kit ressort de porte droite</i>	R9000040	2	2	2	2
10	Kit lampada a led <i>LED lamp kit, LED-Lampensatz, Ensemble de lampes à LED</i>	R9000021	2	4	2	4
11	Alimentatore per lampada a led <i>Power supply for LED lamp, Netzteil für LED-Lampe, Alimentation pour lampe LED</i>	R9000022	2	2	2	2
12	Termostato di sicurezza <i>Safety thermostat, Sicherheitsthermostat, Thermostat de sécurité - fino a matricola up to the serial number bis zur Seriennummer jusqu'au numéro de série 25009217000</i>	R9000013	2	2	2	2
12	Termostato di sicurezza <i>Safety thermostat, Sicherheitsthermostat, Thermostat de sécurité - da matricola from the serial number aus der Seriennummer à partir du numéro de série 25009217001</i>	R9000014	2	2	2	2
13	Contattore <i>Contacteur, Schütz, Contacteur</i>	R9000028	4	4	4	4
14	Kit pietra refrattaria superiore <i>Top refractory stone kit, Top-Feuerfeststein-Bausatz, Kit de pierres réfractaires supérieures</i>	R9000067	2	-	4	-
		R9000068	-	2	-	4
15	Kit pietra refrattaria inferiore <i>Bottom refractory stone kit, Unterer Feuerfeststein-Bausatz, Kit de pierres réfractaires inférieures</i>	R9000067	2	3	-	-
		R9000068	-	-	2	3
16	Resistenza superiore <i>Upper heating element, Oberes Heizelement, Élément chauffant supérieur</i>	R9000005	6	-	-	-
		R9000006	-	6	-	-
		R9000004	-	-	12	16
17	Resistenza inferiore <i>Lower heating element, Unterer Heizelement, Élément chauffant inférieur</i>	R9000005	2	-	-	-
		R9000007	4	-	-	-
		R9000002	-	6	-	-
		R9000004	-	-	4	6
		R9000003	-	-	8	10
18	Maschera adesiva <i>Adhesive label, Étiquette adhésive, Klebeetikett</i>	R9000055	1	1	1	1