

high pressure compressor

low pressure compressor

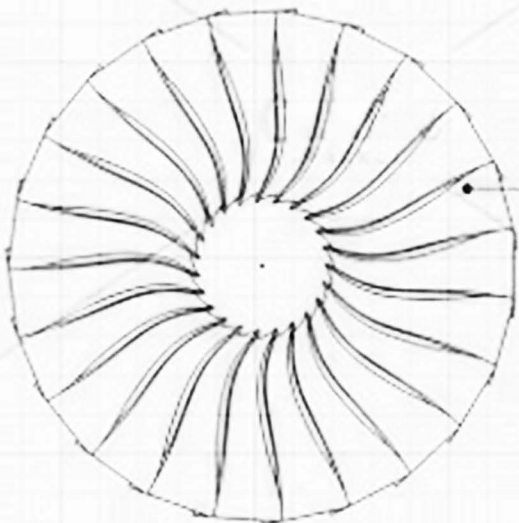

fan

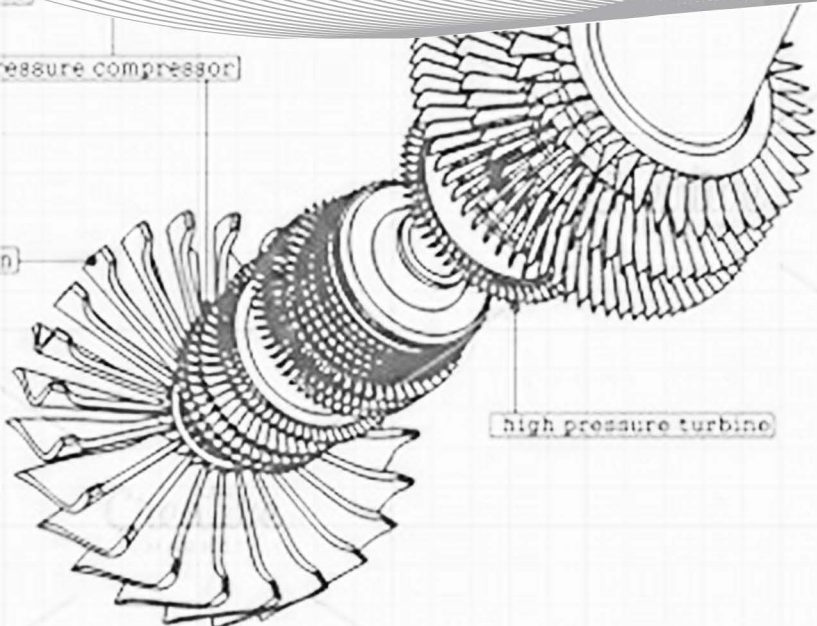

high pressure turbine

**MOD : WR-ROTI-SK**

**Production code : NHK4 (BLUE)\_**

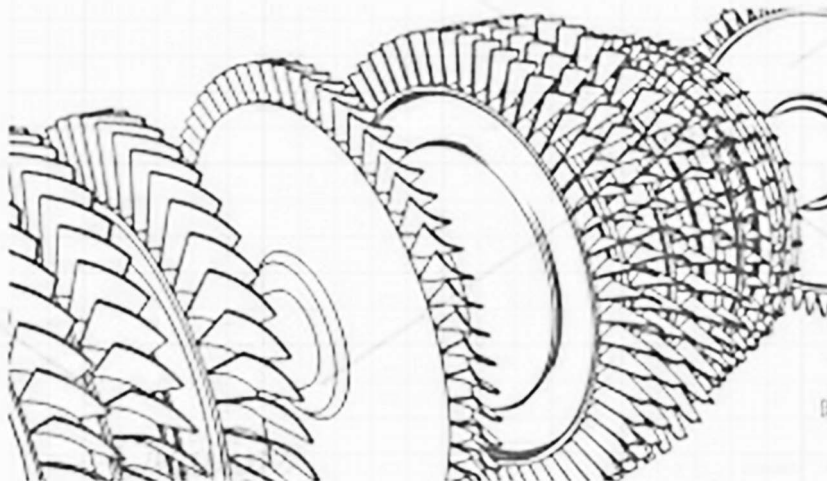
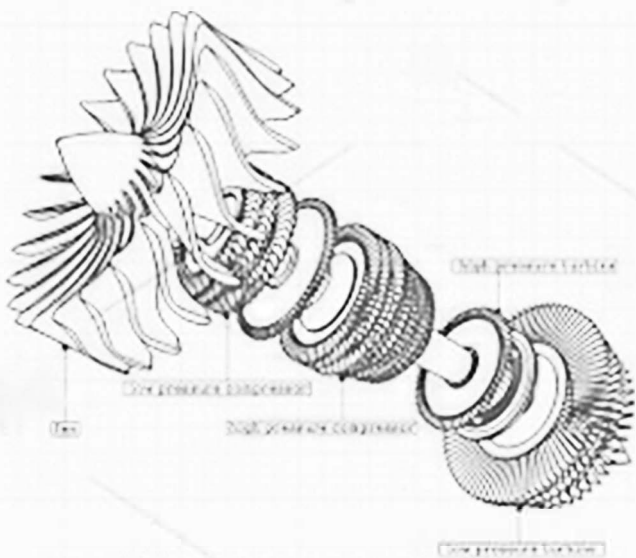

fan

low pressure compressor

low pressure compressor

high pressure turbine

low pressure turbine

low pressure turbine

low pressure compressor

high pressure turbine

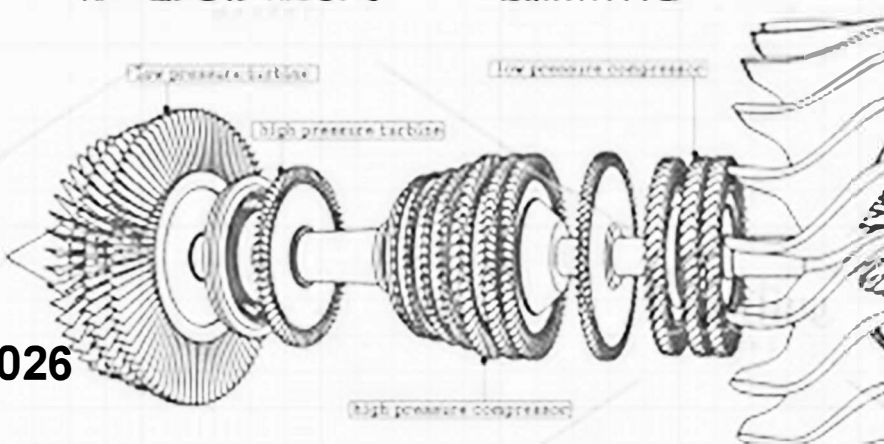
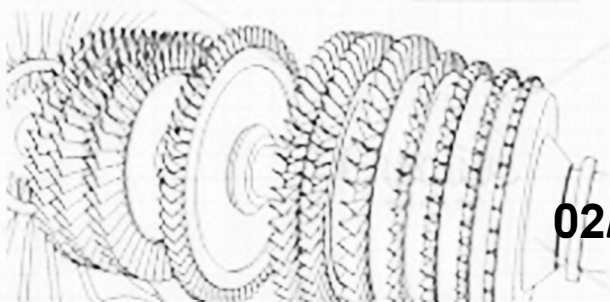

high pressure compressor

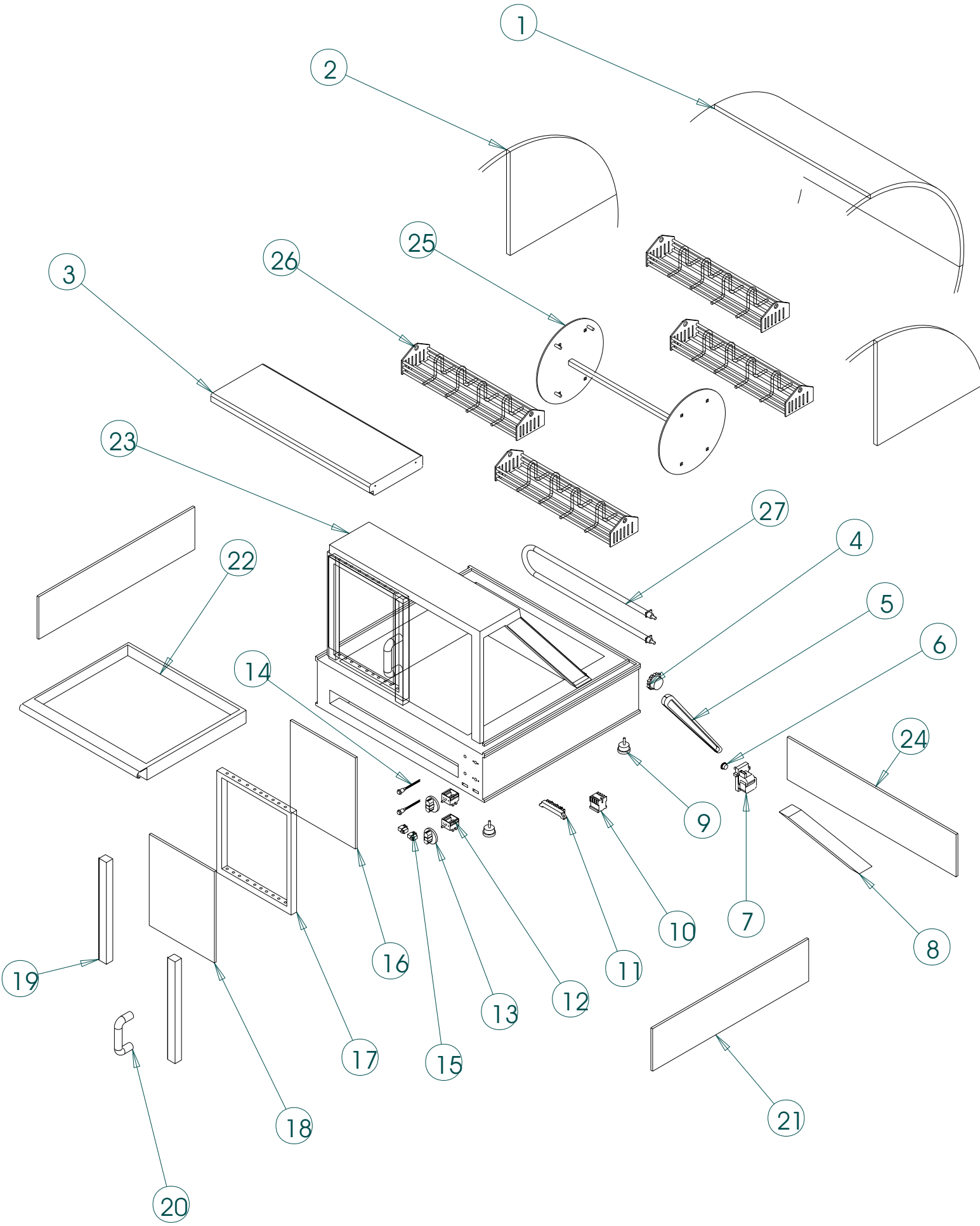

Spare parts list : WR-ROTI-SK	
Explode	DESCRIPTION
Pos.1	Curved Glass
Pos.2	Side Glass
Pos.3	Upper Cover
Pos.4	Gear Top
Pos 5	Chain
Pos 6	Motor Gear
Pos.7	Motor
Pos.8	Side cover
Pos 9	Feet Regulator
Pos 10	Rele
Pos 11	Strip Connector
Pos.12	Operation Switch
Pos.13	Operation knob
Pos 14	Indicate Lamp
Pos 15	On / Off Motor
Pos.16 +Pos.17+Pos.18+Pos.19+Pos.20	Door complete
Pos 21	Side Painted glass
Pos.22	Grease collector
Pos 23	Body
Pos 24	Front painted glass
Pos 25	S/S Wheel
Pos 26	Basket
Pos 27	Heating element