



MOD : TFC3/AG-3

Production code : T8MG3V2510-DM

09/2025

REFRIGERATED COUNTERS



GB

INSTALLATION, OPERATING AND MAINTENANCE INSTRUCTIONS



1. INDEX

1. INDEX.....	1
2. ANALYTICAL INDEX.....	2
3. SAFETY.....	3
4. REGULATIONS AND GENERAL INSTRUCTIONS.....	5
4.1. General information.....	5
4.2. Warranty.....	5
4.3. Replacement of Parts.....	5
4.4. Description of the Appliance.....	6
4.5. Features Plate.....	7
4.6. Personal Protective Equipment.....	8
4.7. Further risks.....	9
5. TRANSPORT AND STORAGE.....	10
5.1. General Information.....	10
5.2. Transport and Handling.....	10
5.3. Storage.....	11
6. INSTALLATION.....	11
6.1. Packaging and Unpacking.....	11
6.2. Installation.....	12
6.3. Electric Power Supply Connection.....	13
6.4. Refrigerant Attachment (Remote Version).....	14
6.5. Inspection.....	14
7. USE AND FUNCTIONING.....	14
7.1. Description of Controls.....	14
7.2. Viewing the LED Display.....	15
7.3. Functions.....	16
7.4. Recommendations for Use.....	19
8. CLEANING AND MAINTENANCE.....	19
8.1. Recommendations for Cleaning and Maintenance.....	19
8.2. Routine Maintenance.....	20
8.3. Extraordinary Maintenance.....	20
8.4. Maintenance intervals.....	21
9. FAULTS.....	22
9.1. Alarms Display.....	23
9.2. Faults Display.....	24
10. TECHNICAL NOTES.....	25
10.1. Disposal of Evaporator Condensate.....	25
10.2. Reversibility Of Doors.....	25
11. DISPOSAL OF THE APPLIANCE.....	26
11.1. Waste storage.....	26
11.2. Equipment disassembly procedure.....	26
12. TECHNICAL DATA SHEET OF REFRIGERANT R134a/R452A.....	27
13. TECHNICAL DATA SHEET OF REFRIGERANT R290.....	27
ATTACHMENTS.....	I

2. ANALYTICAL INDEX

A

Alarms Display; 23

C

Cancelling the list of HACCP alarms HACCP; 18

Compressor operating hours; 18

D

Description of Controls; 14

Description of the Appliance; 6

DISPOSAL OF THE APPLIANCE; 26

E

Electric Power Supply Connection; 13

Enabling / Disabling the Overcooling function; 16

Enabling manual defrost; 16

Enabling the Energy Saving function; 16

Enabling the function for high or low humidity; 16

Extraordinary Maintenance; 20

F

FAULTS; 22

Faults Display; 24

Features Plate; 7

Functions; 16

Further Risks; 9

G

General information; 5

General Information; 10

H

HACCP Alarms; 17

HACCP alarms display; 17

I

Inspection; 14

Installation; 12

L

Locking the keyboard; 16

M

Maintenance intervals; 21

P

Packaging; 11

Parameter setting; 18

Personal Protective Equipment; 8

Prolonged Inactivity; 19

R

Recommendations for Cleaning and Maintenance; 19

Recommendations for normal use; 19

Recommendations for Use; 19

Replacement of Parts; 5

Reversibility Of Doors; 25

Routine Maintenance; 20

S

SAFETY; 3

Setting the time and date; 16

Setting the working setpoint; 16

Storage; 11

Switching the appliance On and Off; 16

Switching the cold room light On / Off; 16

T

Technical Data Sheet of Refrigerant R134a / R452A; 27

Technical Data Sheet of Refrigerant R209; 27

Transport and Handling; 10

U

Unpacking; 11

V

Viewing the LED Display; 15

Viewing the temperature probes; 17

W

Warranty; 5

To highlight certain parts of the text of considerable importance or to indicate certain important specifications, special symbols have been adopted, the meaning of which is described below:



Indicates important information regarding safety. Behave appropriately so as not to risk the health and safety of persons or cause damage.



Indicates particularly important technical information that must not be ignored.

3. SAFETY



It is recommended to carefully read the instructions and warnings contained in this manual before using the appliance. The information contained in the manual is fundamental for the safety of use and for machine maintenance.



Keep this manual carefully so that it can be consulted when necessary. In case of transfer of the equipment, provide the new user with this booklet.



Please contact the manufacturer if you do not fully understand the contents of this manual.



The electric plant has been designed in compliance with the **IEC EN 60335-2-89** Standard.



Warning: R290 cooling gas is potentially flammable and explosive. Every possible safety precaution must be taken to avoid any danger.



Installation, extraordinary maintenance and disposal of the equipment must be performed by qualified personnel, in accordance with the regulations in force in the country of use and in compliance with the regulations relating to installations and safety at work.



The sound pressure level emitted by the equipment is less than 70dB (A). The value may increase depending on the workplace where it is measured.



Maintain ventilation openings in the appliance casing or in the built-in structure free from all obstructions.



Do not use mechanical devices or other means to accelerate the defrosting process, other than those recommended by the manufacturer.



Do not damage the coolant circuit.



Do not use electrical appliances inside the appliance compartments for storage of frozen food.



Do not store explosives, such as pressurised containers with flammable propellant, in this unit.





This equipment is not suitable for storing pharmaceutical, chemical or non-food grade products.





This equipment has not been designed to be installed in a potentially explosive atmosphere.

 Do not place anything on the bottom of the device. Use the appropriate racks to store the product.

 The maximum permissible load for the racks is 20 kg evenly distributed.

 The maximum load allowed per drawer is 25Kg evenly distributed.

 The supply cable must be replaced by qualified personnel.

 Specific adhesives highlight the presence of mains voltage in the proximity of areas (however protected) with risks of an electrical nature.

 Before connection, ensure that the means for disconnecting the equipment from the mains are incorporated into the fixed installation in accordance with the installation rules (required for equipment supplied without a plug to be connected to a permanent installation).

 During the installation of the equipment, it is not allowed the transit or the permanence of people not involved in the installation near the working area; use individual protection devices (gloves, safety shoes, etc.) and operate in compliance with the rules related to the safety at work.

 In the design and construction phase, the manufacturer has paid particular attention to the aspects that can cause risks to safety and health of persons that interact with the appliance.

 Carefully read the instructions stated in the manual and those applied directly to the machine, and particularly respect those regarding safety.

 Do not tamper with, evade, eliminate or by-pass the installed safety devices. Failure to comply with this requisite can lead to serious risks for personal health and safety.

 It is recommended to simulate some test manoeuvres to identify the controls, in particular those relative to switch-on and switch-off and their main functions.

 The appliance is only destined for the use for which it has been designed; any other use must be considered improper.

 The manufacturer declines all liability for any damage to objects or injury to persons owing to improper or incorrect use.

 All maintenance interventions that require precise technical skill or particular ability must be performed exclusively by qualified staff.

 Do not under any circumstances stress the power cable.

 The safety devices must be subjected to periodic inspections as indicated in the chapter on extraordinary maintenance.

 In order to guarantee hygiene and protect the foodstuffs from contamination, the elements that come into direct or indirect contact with the foodstuffs must be cleaned very well along with the surrounding areas. These operations must only be performed using detergents that can be used with foodstuffs, avoiding inflammable products or those that contain substances that are harmful to personal health.

 In the case of prolonged inactivity, as well as disconnecting all the supply lines, it is necessary to accurately clean all internal and external parts of the appliance.

4. REGULATIONS AND GENERAL INSTRUCTIONS

4.1. General information

 This manual has been designed by the manufacturer to provide the necessary information to those who are authorised to interact with the equipment.

 The persons receiving the information must read it carefully and apply it strictly.

 Reading the information contained in this document will allow the user to prevent risks to personal health and safety.

 Keep this manual for the entire operating life of the equipment in a place, which is well known and easily accessible, so that it is always available when its consultation becomes necessary.

 The equipment has been designed for the refrigeration of food. Any other use is considered improper.

 The equipment is not intended for use by:

- persons whose physical, sensory or mental capabilities are impaired.
- children
- persons with a lack of experience and/or knowledge of the product/process.

 The equipment is not suitable for installation outdoors and/or in environments subject to the action of atmospheric agents (sun, rain, etc.).

4.2. Warranty

The warranty of the appliance and the components we produce has duration of 2 (two) year from the date of delivery and translates into the supply, free of charge, of parts that we consider to be faulty. These faults must, however, be independent from incorrect use of the product in compliance with the indications stated in the manual.

Fees deriving from labour, journeys and transport are excluded from the warranty.

The materials replaced under warranty are our property and must therefore be returned under the responsibility and expense of the customer.

4.3. Replacement of Parts

 Activate all envisioned safety devices before carrying out any replacement intervention.

 In particular, deactivate the electrical power supply using the differential isolating switch. Only use original spare parts to replace worn components.

 The manufacturer is not liable for damage or malfunctions caused by:

- non-compliance with the instructions in this manual;
- repairs not performed in a workmanlike manner;

- use of non-original spare parts;
- interventions by non-skilled technicians;
- unauthorised intervention;
- lack of preventive maintenance;
- improper use of the equipment
- unforeseeable events
- use of the equipment by insufficiently trained staff
- non-application of the safety and hygiene regulations in force in the country of use.

 We accept no liability for damage caused by conversions and/or modifications made by the end user.

4.4. Description of the Appliance

The refrigerated table, from now on defined as appliance, has been designed and built to preserve foodstuffs in the professional catering ambit.

- 1) **condensation area:** it is positioned in the right or left side and is characterised by the presence of the condensing unit.
- 2) **electric area:** it is positioned in the front part of the condensing unit and contains the control and power supply appliance as well as electric wiring.
- 3) **evaporation area:** it is situated inside the refrigerated compartment in the right or left side (ventilated) or in the rear (static) and is characterised by the evaporating unit.
- 4) **storage area:** it is situated inside the refrigerated compartment (in models with refrigerated drawer above the technical compartment also in the upper right area) and is destined for the preservation of foodstuffs.

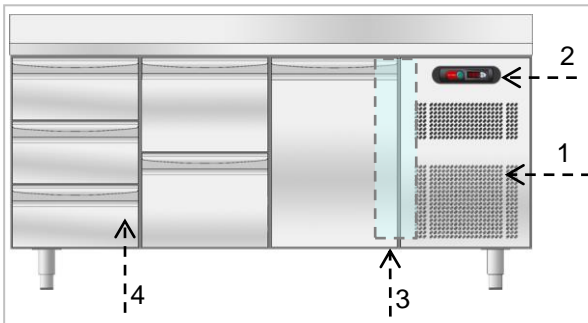

In REMOTE VERSION models the condensation area is not present and is replaced by a compartment in which the following evaporator outlet pipes appear:

- Gas intake pipe = $\varnothing 10$ mm, insulated
- Liquid delivery pipe = $\varnothing 6$ mm, insulated

In the front part there are one or more doors or drawers, which close the refrigerated compartment hermetically.

Depending on requirements, the appliance is produced in several versions.

STATIC TABLES (0°C + 15°C)

Model suitable for the preservation of fresh foodstuffs for which forced circulation of air inside the refrigerated compartment is not recommended. The period of preservation must be intended as quite limited.

TN VENTILATED TABLES (-2°C +8°C)

Model suitable for preservation of fresh foodstuffs, packed pre-cooked foods and beverages. The period of preservation must be intended as quite limited.





BT VENTILATED TABLES (-20°C -10°C)

Model suitable for the preservation of deep-frozen products for long periods of time.

4.5. Features Plate

The identification plate shown is applied directly onto the appliance. It states the references and all indications indispensable for working in safety.

- 1) Equipment code
- 2) Equipment description
- 3) Serial number
- 4) Power supply voltage and frequency
- 5) Rated power
- 6) Defrosting output
- 7) Total lamps output
- 8) Climate Class
- 9) Type and Quantity of Cooling Gas
- 10) Number of the refrigerant of the main component of the foam insulation gas
- 11) WEEE mark

		2018
Code Kode Codice	XXXXXXXX	①
Descrizione / Description	Refrigerated Cabinet	②
Serial No./ Serien Nr./ Matricola	XXXX.XXXX	③
Tension / Spannung / Tensione	xxx V~ xx Hz	④
Input / Leistungsaufnahme / Potenza	xxx W xxx A	⑤
 Defrost Power / Potenza Sbrinamento	xxx W	⑥
Climate Class / Klimaklasse / Classe Climatica	5	⑧
Refrigerant Kuehlmittel Refrigerante	xxxx xxxx Kg	⑨
Insulation Isolierung Isolamento	HFO1233zd	⑩
⑪ 		Max  xx W ⑦

GB

The climate class described on the identification plate refers to the following values:

Climate Class	EN 60335-2-89	EN ISO 23953	
	Room Temperature	Room Temperature	Relative Humidity
5	43°C	40°C-	40%

4.6. Personal Protective Equipment

The identification and selection of appropriate personal protective equipment is the responsibility of the employer or workplace manager or service technician.

Operators are required to wear the identified equipment.

During ordinary use, gloves protect hands from cold baking sheet pan.

The following is a list of the main personal protective equipment (PPE) to be used during the various work operations.

Task	Protective clothing	Safety shoes	Gloves	Glasses	Helmet or hard hat
Transport and handling		■	□		□
Unpacking		■	□		
Assembly		■	□		
Ordinary use	■	■	□		
Ordinary cleaning	□	■	■	□	
Extraordinary cleaning	□	■	■	□	
Maintenance	□	■	□		
Dismantling	□	■	□		
Scrapping	□	■	□		

■ Mandatory personal protective equipment (MPPE)

□ Personal protective equipment (PPE) to be used if necessary

4.7. Further risks

The proper design of the equipment and the installation of adequate protection do not completely exclude risks to the operator.

This manual lists the personal protective equipment to be used by the operator.

Sufficient space is provided during the installation of the equipment to limit the risks. To maintain these conditions, the areas surrounding the equipment must be kept clean, dry, well lit and free of obstacles.

The following is a list of possible risks that may still occur.

Possible risks	Description
Slip or fall	The operator may slip due to water, oil or dirt on the floor.
Burns Abrasion	The user intentionally or unintentionally touches certain components inside the appliance (e.g. cold pans, cooling fins and cooling circuit tubes) without wearing protective gloves.
Electrocution	Contact with live electrical parts during maintenance operations performed without disconnecting the power supply.
Fall	The operator intervenes on the equipment using unsuitable means to access the upper part.
Injuries	The upper control panel may not be secured properly by qualified personnel. It may close abruptly.
Tipping	During equipment and packaging handling operations using unsuitable lifting and/or handling equipment or with an unbalanced load.
Cooling gas	Inhalation of cooling gas. The type of refrigerant can be found on the equipment's identification plate.

5. TRANSPORT AND STORAGE

5.1. General Information

The equipment must be transported and handled using appropriate means with adequate capacity.

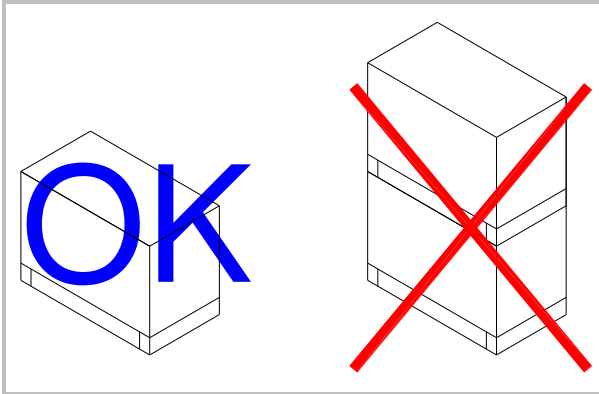

 During transport and handling of the equipment, it is strictly forbidden to stack one machine on top of the other, in order to exclude the risk of loads tipping over due to stacking.

5.2. Transport and Handling

 It is forbidden to stand under suspended loads during handling and transport. Unauthorised personnel may not enter the work area. The transported load can move when braking, accelerating, cornering and on rough roads.

 The equipment must be handled in a vertical position. It is forbidden to move the equipment in a horizontal position. If the equipment is handled in a horizontal position, wait a few hours before operating it. For the correct performance of lifting operations, use the most suitable type of equipment in terms of characteristics and load capacity: forklift or transpallet.

 The equipment must only be transported, handled and stored by skilled staff. Minimum requirements for skilled staff are as follows:

- specific technical training and experience in the use of lifting systems;
- knowledge of safety regulations and applicable laws;
- knowledge of general safety requirements;
- respect for the use of personal protective equipment in accordance with the operation performed;
- the ability to identify in advance and avoid any possible danger.

 Avoid pushing or dragging the equipment when handling it.

 Before lifting, secure the surrounding area and prevent access to personnel. Move the equipment to a minimum height above the ground and ensure the stability of the load.

 Do not lift the equipment in any other way than explained in this manual. Before placing the load, check that the floor is level and has sufficient load-bearing capacity to support the weight of the load.

5.3. Storage

 The equipment must be stored in a non-aggressive, vibration-free environment.



 The room temperature should be between -10°C and +50°C. Avoid excessively humid environments. The storage place must have an adequate support surface to prevent deformation of the machine or damage to the support feet.

 Only skilled staff is allowed to perform positioning, assembly and disassembly of the equipment.

 **STACKING LIMITS:** during storage the stacking limit of the appliances is equal to a maximum of 2.

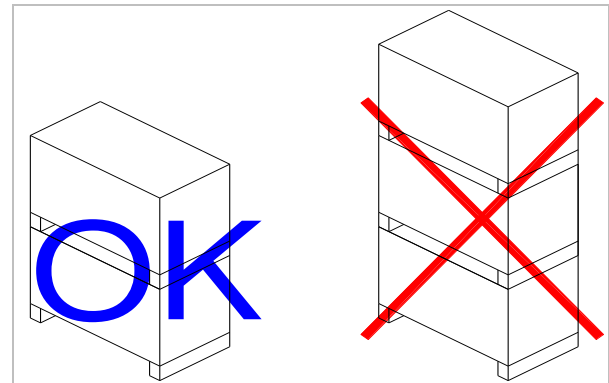



GB

6. INSTALLATION

6.1. Packaging and Unpacking

Move and install the appliance respecting the information provided by the manufacturer, shown directly on the packaging, on the appliance and in this manual.

 Wear protective gloves before unpacking.

 Avoid pushing or dragging the equipment to avoid risks of tipping over and damage to the structure.

The lifting and transportation system of the packaged product envisages the use of a fork-lift truck or a pallet stacker, using which particular attention must be paid to balancing the weight in order to prevent the risk of overturning (avoid excessive tilting!).

 **ATTENTION:** When inserting the lifting device, pay attention to the gas supply pipe and the position of the feet.

The packaging is made of cardboard and the pallet of wood. A series of symbols is printed on the cardboard packaging that highlights, in

accordance with international standards, the provisions, which the appliances must be subject to during loading, unloading, transportation and storage.



On delivery, check that the packaging is intact and has not suffered any damage during transportation.

Any damage must be notified to the transportation company immediately.

The appliance must be unpacked as soon as possible to check that it is intact and undamaged.

Do not cut the cardboard with sharp tools in order to prevent damage to the steel panels underneath.

Pull the cardboard packaging upwards.

After having unpacked the appliance, check that the features correspond to those requested in the order;
For any anomalies, connect the dealer immediately.

i On stainless steel equipment, carefully remove the protective film from the inner and outer walls, avoiding the use of metal tools. If adhesive remains on the walls of the machine, remove it using a non-corrosive solvent; rinse and dry thoroughly after cleaning. It is advisable to apply a protective oil layer to all steel surfaces.

! Packaging elements (nylon bags, polystyrene foam, staples ...) must not be left within reach of children.
Remove the protective PVC film from the internal and external walls, avoiding the use of metal tools.

i Packaging must be disposed of in accordance with the regulations in force in the country where the equipment is used.

6.2. Installation

! Installation and assembly operations must be carried out by qualified personnel.

! If the equipment uses R290 cooling gas, every possible precaution must be taken to avoid any danger linked to the flammability of this gas.

i All the installation phases must be considered, from the moment of creation of the general plan.

! Installation and assembly operations must be carried out in accordance with current safety regulations.

! The equipment used for installation and assembly operations must comply with current safety standards.

i The installation area must be equipped with all power supply and production residue drainage connections and must be suitably lit and respect current laws regarding hygiene and sanitary requirements.

i To optimise consumption and reduce wear of the machine, do not position it near heat sources or in environments where temperatures are too high. Proceed with machine levelling, adjusting the individual feet.

i Do not push or drag the appliance during installation to avoid it toppling over or causing damage to parts or persons.

! This appliance can only be installed and operate in rooms, which are permanently ventilated, in order to guarantee correct operation.

i Do not expose the equipment to direct sunlight;

i Connect and leave for a certain period of time (at least 2 hours) before checking functioning. During transport, it is probable that the compressor lubricant oil has entered the refrigerant circuit blocking the capillary: therefore, the appliance will function for a certain period without producing cold until the oil has returned to the compressor.

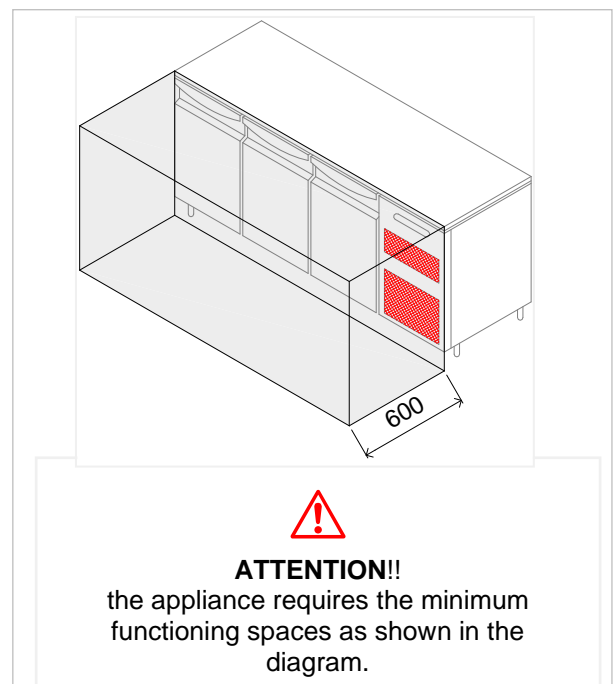



 The size of the compartment that houses the equipment must be such as to avoid excessive concentrations of gas in the event of a leak from the refrigeration circuit and in any case, the compartment must have a free area NEVER

smaller than 4 times the space occupied by the equipment. Adequate space must be provided to ensure effective escape routes at all times. The above-mentioned compartment must be well ventilated.

6.3. Electric Power Supply Connection

 Connection must be carried out by authorised and qualified staff, respecting the current laws regarding the subject and using appropriate prescribed material.

 Before connecting the appliance to the electric mains check that the voltage and the frequency correspond to the data stated on the registration plate applied on the rear of the appliance.

 The equipment is supplied with one of the following operating voltages:

- 230V 1~ 50Hz
- 220V1~ 60Hz.

 Provide an earthed socket with a capacity appropriate to the absorption indicated on the identification plate.

 It is forbidden to operate the equipment connected to an ungrounded system.

 For direct connection to the power supply, a device must be provided to ensure disconnection from the power supply, with a contact-opening distance allowing complete disconnection under the conditions of overvoltage category III, in accordance with the installation rules.

 Refer to the technical data on the identification plate for the correct sizing of the switch.

 The switch-disconnector must be located close to the equipment, must be visible to the operator and must be indicated by an information sign.

 If a plug is used, it must comply with national installation regulations.

 The plug must be accessible even after the equipment has been placed in the installation location.

 The plug must always be visible to the operator performing the maintenance operation.

 After the electrical connection, check that the supply voltage, when the equipment is running, does not deviate from the nominal value given on the specifications plate $\pm 10\%$.

 The power cable used for connection to the mains supply is of type H05VV-F; when replacing it, use a cable with the same or better characteristics.

 When replacing the power cable, the earth conductor must be kept longer than the active conductors.

 The replacement of a damaged power cable must be done by a qualified technician in order to prevent any possible risk.

6.4. Refrigerant Attachment (Remote Version)

The "remote" condensing unit connection must be carried out according to the attached refrigerator lay-out. Remember that the following are present in the technical compartment:

- Intake pipe.
- Liquid delivery pipe.

These are therefore connected with the corresponding types present in the condensing unit.

When the connection has been made, carefully empty and then load paying attention to use a type of refrigerant gas that is compatible with the components present.

For the start-up of the appliance, carry out electric connections between the instruments present on the control panel and condenser unit according to the attached wiring diagram.

6.5. Inspection

The appliance is delivered in conditions that it can be started-up by the user.

This functionality is guaranteed by passing the tests (electric inspection - functional inspection, appearance inspection) and relative certification through the specific attachments.

In the first use, the equipment, due to the evaporation of moisture from insulating materials, could produce unpleasant odors that will gradually disappear in subsequent cycles.

7. USE AND FUNCTIONING

7.1. Description of Controls



ON ... OFF Key

A pressure on the **ON/OFF** key causes the controller to be switched on. A pressure of 2 seconds forces the controller to switch off.



SET key

A pressure during normal operation allows the working setpoint to be set.



Defrost / Energy Saving key

A pressure during normal operation starts the Energy Saving function.

A prolonged pressure for at least two seconds starts a manual defrost.



Light Key

A pressure during normal operation allows the light to be switched on or off.



Increase ... Decrease keys

Pressing the buttons, in setpoint programming, parameters and humidity (if available) decreases or increases the selected value.



A prolonged pressure of the key  for at least two seconds starts the Overcooling function.

7.2. Viewing the LED Display

There are a number of graphic signals within the display area.

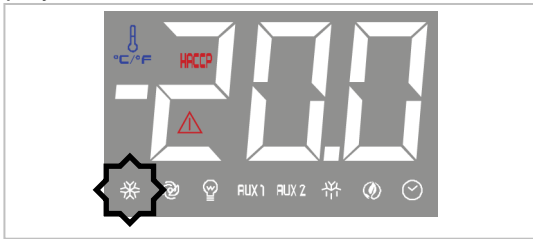

This LED indicates the state (on or off) of the COMPRESSOR

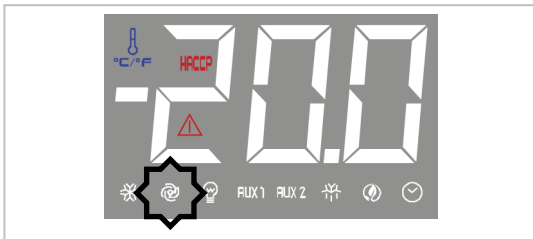

This LED indicates the state (on or off) of the FAN

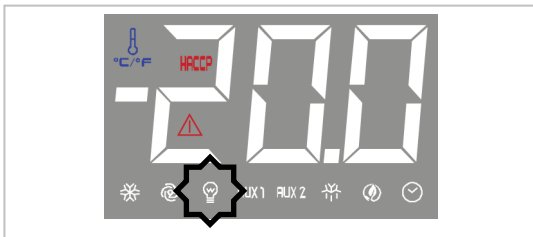

This LED indicates the state (on or off) of the LIGHT

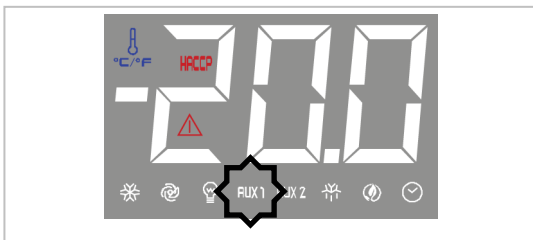

This LED indicates the state (on or off) of the DOOR HEATING ELEMENT

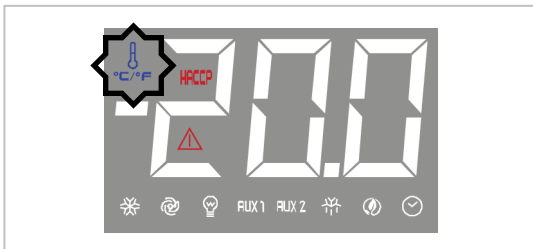

The flashing icon indicates the activation of the OVER COOLING function

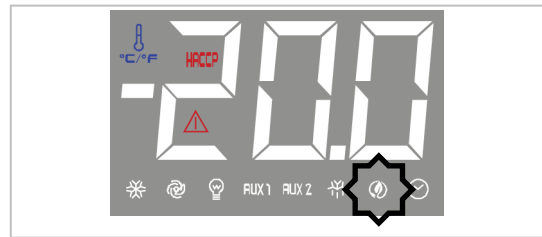

This LED indicates the activation of the ENERGY SAVING function

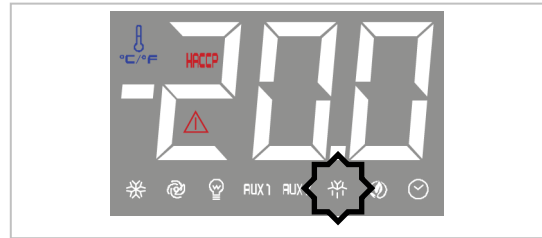

This LED indicates that defrosting is in progress

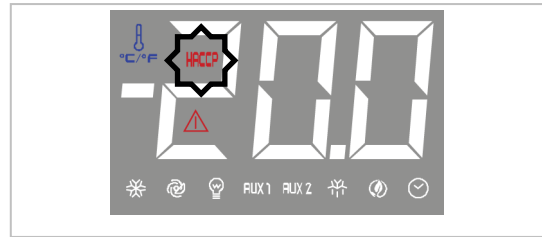

This LED indicates an HACCP alarm



This LED indicates an HACCP state of ALARM / FAILURE

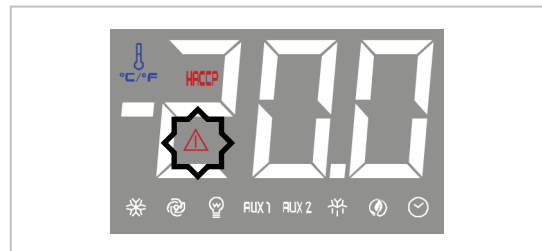

The flashing LED calls for cleaning the condenser filter





GB

7.3. Functions



Switching the appliance On and Off

Make sure the keyboard is not locked. Hold the  key down for two seconds. The display will turn on / off.



Setting the working setpoint

Make sure the keyboard is not locked. Press and release the  **SET** key: the led  will flash. Set the new working setpoint with the keys  . Confirm the new value with the  **SET** key.



Switching the cold room light On / Off

Make sure the keyboard is not locked. Press and release the  key: the led  will turn on. To turn the light off press the  key again.

Enabling / Disabling the Overcooling function

Make sure the keyboard is not locked. Press the   key for at least 2 seconds. During the Overcooling function, the setpoint is decreased by 1°C. During the Overcooling function defrost is never enabled; the icon  flashes. The function ends two hours after activation.

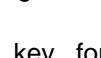
Enabling manual defrost

Make sure the keyboard is not locked and that the Overcooling function is not in progress. Press the   key for at least 2 seconds. If the temperature of the evaporator probe is not greater than the set limit, the defrost function is enabled and the  led will turn on. When defrost is finished the  led will turn off.

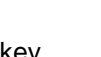

Enabling the Energy Saving function

Make sure the keyboard is not locked. Press the   key. During the Energy Saving function the setpoint is increased by 1°C. The Energy Saving function ends 6 hours after activation.

Enabling the function for high or low humidity

Make sure the keyboard is not locked.

Press the  key for at least one second. The screen displays the label 'rCH'.

Tap the  or  key to select 'rH'. To display the current operation press the  **SET** key: the display shows 'rhH' if high humidity operation is active, 'rhL' if low humidity operation is active

To change the function press the  **SET** key for at least 2 seconds: the screen displays 'rhH' (high percentage of humidity function) or 'rhL' (low percentage of humidity function).

To exit the procedure, press .

Locking the keyboard

After 30 seconds without key operation, the display will show the label 'Loc' and the keyboard will immediately lock.

To unlock the keyboard, press any key. The display will show the label 'UnL'.

Setting the time and date

Make sure the keyboard is not locked.



Press the  key for 1 second: the screen displays the 'rCH'.

Tap the  or  key to select 'rtc'.



Press the  **SET** key: the screen displays the label 'y' followed by the last two numbers of the year.

Tap the  or  keys to set the year.



Confirm the value by pressing the  **SET** key. The screen displays the label 'm' followed by the last two numbers of the month (01...12).

Tap the  or  keys to set the current month. Confirm the value by pressing the  **SET** key.



The screen displays the label 'd' followed by the last two numbers of the day (01...31).

Tap the  or  keys to set the current day. Confirm the value by pressing the  **SET** key.

The screen displays the label 'h' followed by the last two numbers of the hour (00...23).

Tap the  or  keys to set the current hour. Confirm the value by pressing the  key.

The screen displays the label 'n' followed by the last two numbers of the minutes (00...59).

Tap the  or  keys to set the minutes. Confirm the value by pressing the  key.

The screen displays the label of the day of the week.

Label	Meaning
Mon	Monday
tuE	Tuesday
UEd	Wednesday
thu	Thursday
Fri	Friday
Sat	Saturday
Sun	Sunday

Tap the  or  keys to set the day of the week.

Confirm the value by pressing the  key, the device will exit the procedure.

At any time, it is possible to exit the procedure by pressing .



Viewing the temperature probes

Make sure the keyboard is not locked.



Press the  key for at least 1 second. The screen displays the label 'rCH'.

Tap the  or  to select the entry 'Pb1' (cell probe).

Press the  key to display the value measured by the cell probe.

Tap the  or  to select the entry 'Pb2' (evaporator probe).

Press the  key to display the value measured by the evaporator probe.

Tap the  or  to select the entry 'Pb3' (condenser probe).

Press the  key to display the value measured by the condenser probe.

Press  to exit the procedure: the display shows again the temperature read by the cell probe.

HACCP Alarms

The device can store up to 9 HACCP alarms, whereupon the most recent alarm overwrites the oldest. The instrument provides the following information

- alarm code
- the critical value
- the date and time when the alarm occurred
- the duration of the alarm (from 1 min to 99 h 59 min, partial if alarm is in progress).

The following alarm codes are provided:

- **AL**: minimum temperature alarm
- **AH**: maximum temperature alarm
- **id**: door switch input alarm
- **PF** power failure alarm

 To avoid repeatedly storing power failure alarms, disconnect the power supply when the device is switched off.

 If the duration of the power failure alarm is such that it causes the clock error (code 'rtc'), the device will not provide any information regarding the duration of the alarm.

HACCP alarms display

Make sure the keyboard is not locked.



Press the  key for at least 1 second: the screen displays the label 'rCH'.

Tap the  or  to select the entry 'LS'.

Press the  key: the screen will display the code for the most recent alarm (in other words, one of the codes listed above followed by number "1"; the greater the number that follows the code

for the alarm, the older it is). With the 

and  key it is possible to scroll through the various stored alarms.

To select an alarm, press the  key: the led  will stop flashing and stay on steadily, the screen will display the following information in sequence:

8.0	the critical value is 8.0 °C/8 °F
StA	the screen is about to display the date and time when the alarm was set off
Y22	the alarm was set off in 2022

	(continue ...)
n03	the alarm was set off in the month of March (continue ...)
d26	the alarm was set off on March 26, 2022
h16	the alarm was set off at 16:00 (continue ...)
n30	the alarm was set off at 16:30 (continue ...)
dur	the screen will display the duration of the alarm
h01	the alarm lasted for 1 h (continue ...)
n15	the alarm lasted for 1 h and 15 min
AH3	the selected alarm

The screen displays every piece of information for 1 second.

To exit the sequence of information: press and

release the  **SET** key, the screen displays the selected alarm (in the example 'AH3').

Press  **SET** to exit the procedure: the display shows again the temperature read by the cell probe.



 If the device has no alarm stored, the label 'LS' will not be displayed.

Cancelling the list of HACCP alarms

Make sure the keyboard is not locked. Press the  key for at least 1 second: the screen displays the label 'rCH'.

Tap the  or  key to select the entry 'rLS'.

Press the  **SET** key: a password is requested in order to delete alarms in memory.

With the  or  key, enter the password **149**: press the  **SET** key to confirm the deletion of the alarms.

 If the device has no alarm stored, the label 'rLS' will not be displayed.

Compressor operating hours

To display the compressor operating hours, follow the instructions below.
Make sure the keyboard is not locked.



Press the  key for at least 1 second.
The screen displays the label 'rCH'.

Tap the  or  key to select the entry 'CH'.

Press the  **SET** key to display the data.
To reset the counter perform the following steps.
Make sure the keyboard is not locked.

Press the  key for at least 1 second.
The screen displays the label 'rCH'.



Press the  **SET** key: a password is requested in order to reset the counter.

With the  or  key, enter the password **149**: press the  **SET** key to confirm.





Parameter setting

Make sure the keyboard is not locked. Press the  **SET** key for at least 4 seconds, the screen displays the label 'PA'.

Press the  **SET** key: a password is requested in order to enter the parameters.

With the  or  key, enter the password **149**: press the  **SET** key to confirm
The display will show 'SP' (first available parameter).

With the  or  keys it is possible to scroll through the parameter list.

Press the  **SET** key to change the parameter using the  or  keys: press the  **SET** key to confirm the change.

To exit the procedure press .

 To make certain parameters operational, it is necessary to switch the equipment off and on again.

7.4. Recommendations for Use

Prolonged Inactivity

If the appliance remains inactive for a long period, proceed as follows:

1. Use the automatic disconnecting switch to deactivate connection to the main electrical line.
2. Clean the appliance and surrounding areas thoroughly.
3. Spread a thin layer of cooking oil onto the stainless-steel surfaces.
4. Carry out all maintenance operations.
5. Leave the doors ajar to prevent the formation of mould and/or unpleasant odours.

Recommendations for normal use

In order to ensure correct use of the appliance, it is advisable to apply the following recommendations:

- Do not obstruct the zone in front of the condensing unit in order to favour heat disposal from the condenser to a maximum.
- Always keep the front of the condenser clean using a soft brush and do not use rigid or metal tools that may damage the condenser fins.
- Check the planarity of the appliance rest surface.
- Do not introduce liquid or solid substances at temperatures above the environmental temperature and, however, introduce the material after the appliance has reached the functioning temperature.
- Do not stack the materials to be preserved in contact with the internal walls, so blocking the circulation of air, which guarantees uniformity of the internal temperature of the refrigerated compartment.
- Avoid placing paper, cardboard, chopping boards, etc. on the grills, which can obstruct the air circulation.
- Pack or otherwise protect food, especially if it contains flavourings or spices.
- Limit the number of times and the duration of time the doors are open to a maximum.
- If the door has been opened, wait a few moments before opening it again.
- Gradually arrange the food inside the compartments or drawers from the bottom upwards; conversely, remove the food from the top downwards.



Food must be placed in covered containers suitable for food contact. The containers must be evenly and uniformly arranged within the refrigerated compartment to allow free circulation of air.

8. CLEANING AND MAINTENANCE

8.1. Recommendations for Cleaning and Maintenance



Activate all envisioned safety devices before carrying out any maintenance interventions. In particular, deactivate the electrical power supply using the automatic isolating switch.

During maintenance, the cable and plug must be visible to the operator performing the operation.

Do not touch the equipment with wet or damp hands or bare feet.

Do not remove safety guards.

Use appropriate personal protective equipment.

During maintenance, there are still some risks that cannot be avoided and which must be neutralised by adopting appropriate behaviour.

It is forbidden to carry out inspection, cleaning and/or maintenance operations on moving parts.

8.2. Routine Maintenance

Routine maintenance consists of daily cleaning of all the parts which can come into contact with foodstuffs.

Correct maintenance allows the user to maximise performance levels and operating life and constantly maintain safety requirements.

Do not spray the appliance with direct jets of water or high pressure appliances.

When cleaning stainless steel, do not use iron wool, brushes or scrapers as ferrous particles could be deposited which, on oxidising, could lead to rust.

 To remove hardened residue, use a soft sponge dipped in warm water and neutral detergent. Moisten the hardened residue for at least half an hour, then remove the residue with a sponge dipped in water and neutral detergent. If necessary, use wooden or plastic scrapers or abrasive rubber soapsuds. At the end of the operation, rinse the area thoroughly and then dry using a clean sponge.

 Clean door seals frequently. Some stored products may release substances that attack the gasket, deteriorating it very quickly.

During long periods of inactivity, spread a protective layer on all stainless steel surfaces by wiping them with a cloth soaked in Vaseline oil and airing the rooms periodically.

 Do not use products, which contain substances, which are harmful and dangerous for personal health (solvents, petrol etc.).

 Clean interior steel surfaces using a cloth soaked in warm water and neutral detergent or products specifically for steel. After washing, rinse and dry thoroughly. Refrigerated compartments should be cleaned daily to maintain a high level of hygiene.

 Use a specific product (non-alcoholic) to clean the control panel. Do not spray water or detergent directly onto the instrument to avoid seepage that could damage the display.

8.3. Extraordinary Maintenance

 Extraordinary maintenance operations must be carried out by skilled technical staff, equipped with all personal protective devices.

 It is forbidden to remove or tamper with guards and safety devices while the machine is running.

 Procedures for topping up the refrigerant and repairing gas leaks may only be carried out by personnel who meet all the requirements of the regulations in force in the country where the equipment is used.

 In the case of flammable refrigerant gases, R290, R600a or other hydrocarbons, disconnect the machine from the power supply and completely purge the refrigerant circuit with an inert gas before proceeding with welding or other work requiring flames or sparks.

 For refrigerant gases such as R452A, R134a or other greenhouse gases comply with the

regulations in force concerning the handling of Fgas.

 In the event of hazardous situations being observed, e.g. damage and exposure to sharp objects, damage to electrical or thermal insulation, the equipment must not be operated or used and must be secured as soon as possible, preventing access to the surrounding area if necessary.

 **Periodically** have the following operations carried out by specialised staff:

- Periodically clean the condenser using suitable tools (suction device or soft brushes).
- Check the perfect sealing of the door gaskets and replace them if necessary.
- Periodically clean the condensate evaporation tray.
- Check that the electric connections have not loosened.
- Check the efficiency of the heating element (in BT models).
- Check functioning of the remote-thermostat or cards and probes.
- check the efficiency of the electrical system.









8.4. Maintenance intervals

In order to assure constant efficiency of the equipment, it is advisable to inspect the equipment at intervals indicated in the following table:







Operation	Description	Interval
Routine cleaning	General cleaning of equipment and surrounding work area	daily
Mechanical protections	Inspection of the state of preservation of the external mechanical parts; check for any deformation, loosening or removal	monthly
Control	Check of the mechanical part; check for cracks or deformations; check for tightness of screws; check of the state of preservation of the stickers and danger/information symbols.	yearly
Machine structure	Check tightness of screws, main fasteners, etc.	yearly
Safety signs	Check legibility and state of preservation of signs	yearly
Electrical panel	Checking the state of preservation of electrical components and wiring between the switchboard and electrical components.	yearly
Connecting cable, socket and plug	Check the state of preservation of components (replace if necessary)	yearly
General equipment inspection	Complete general inspection of the equipment	10 years

9. FAULTS

The information shown below aims to help with the identification and correction of any anomalies and malfunctions which could occur during use. Some of these problems can be resolved by the user. For the others, precise competency is required, and they must therefore only be carried out by qualified staff.

Problem	Causes	Solutions
The refrigerator unit does not start	End of defrosting	it starts after a pause of 3 minutes
	Switch-off by means of master switch	re-started, starts up after 3 minutes
	No voltage	check plug, sockets, fuses and electric mains
	Other causes	 If the problem persists, contact the after-sales centre.
The refrigerator unit functions continuously, cooling insufficiently	Room too hot	air the environment
	Dirty condenser	clean the condenser
	Insufficient door sealing	check the gaskets
	Insufficient quantity of refrigerant gas	 Contact the after-sales centre.
	Hot gas valve partially open	 Contact the after-sales centre.
	Resistances always inserted	check timer (only on models with electric defrosting)
	Condenser fan at a standstill	 Contact the after-sales centre.
	Evaporator fan at a standstill	 Contact the after-sales centre.
The refrigerator unit does not stop	Probe faulty	 Contact the after-sales centre.
	Remote-thermostat or thermostat faulty	 Contact the after-sales centre.
Presence of ice inside the evaporator	Drain pipe blocked	disassemble and re-assemble the drain unit after having checked its cleanliness
	Appliance not level	use the adjustable feet to level
	Hot gas valve failure	 Contact the after-sales centre.
	Resistances not functioning	check defrosting activation (only on models with electric defrosting)
Appliance noise	Persistent vibrations	check there is no contact between the appliance and other objects inside or outside

9.1. Alarms Display

Problem		Causes	Solutions
AL	"AL" flashes on the display and the buzzer emits an intermittent noise	The temperature detected by the evaporator probe is lower than the established value.	 Contact the after-sales centre. <ul style="list-style-type: none"> ➤ Make sure the evaporator fan is operating. ➤ Make sure the system is not discharged.
	Low evaporator temperature alarm		
AH	"AH" flashes on the display and the buzzer emits an intermittent noise	The temperature detected by the cold room probe is higher than the established value.	<ul style="list-style-type: none"> ➤ Check the cold room temperature ➤ Make sure the system is operating correctly.
	High cold room temperature alarm		
id	"id" flashes on the display and the buzzer emits an intermittent noise	The door microswitch input stays open.	 Contact the after-sales centre. <ul style="list-style-type: none"> ➤ Check the door micro ➤ Make sure the door is aligned correctly
	Door microswitch input alarm		
PF	"PF" flashes on the display and the buzzer emits an intermittent noise	There has been a power failure.	<ul style="list-style-type: none"> ➤ Check the electrical system.  To avoid having to memorise power failure alarms repeatedly, turn the tool off before disconnecting the power supply.
	electrical power supply failure alarm		
COH	"COH" flashes on the display and the buzzer emits an intermittent noise	The temperature detected by the condenser probe is higher than the established value.	 Contact the after-sales centre. <ul style="list-style-type: none"> ➤ Air the environment. ➤ Clean the condenser.
	Condenser temperature alarm		
CSd	"CSd" flashes on the display and the buzzer emits an intermittent noise	The temperature detected by the condenser probe is higher than the established value.	 Contact the after-sales centre. <ul style="list-style-type: none"> ➤ Clean the condenser. ➤ Check that the condenser fans are functioning correctly.
	Condenser fan blocked alarm		
dFd	"dFd" flashes on the display and the buzzer emits an intermittent noise	Defrosting ended after the maximum time set by parameter d3.	<ul style="list-style-type: none"> ➤ Check defrosting efficiency.  If the problem persists, contact the after-sales centre.
	Defrosting timeout alarm		

9.2. Faults Display

	Problem	Causes	Solutions
Pr1	"Pr1" flashes on the display and the buzzer emits an intermittent noise	<ul style="list-style-type: none"> ➤ The wrong type of probe is installed. ➤ The probe is faulty. ➤ The probe – circuit board connection is incorrect. ➤ The temperature detected by the probe is out of the limits accepted by the cold room probe in use 	<p> Contact the after-sales centre.</p> <ul style="list-style-type: none"> ➤ Check that the cold room probe is the NTC type. ➤ Check the integrity of the cold room probe. ➤ Check correctness of the instrument - probe connection. ➤ Check that the temperature in proximity of the cold room probe is not out of the accepted limits
	Cold room probe error		
Pr2	"Pr2" flashes on the display and the buzzer emits an intermittent noise		
	Evaporator probe error		
Pr3	"Pr3" flashes on the display and the buzzer emits an intermittent noise		
	condenser probe error		
rtc	The letters "rtc" will flash on the screen	The current time setting has been deleted.	<ul style="list-style-type: none"> ➤ Set the day and time.
	Clock error		

10. TECHNICAL NOTES

10.1. Disposal of Evaporator Condensate

The elimination of the condensate produced during the defrosting phase takes place AUTOMATICALLY and therefore does not require any manual operation.

10.2. Reversibility Of Doors

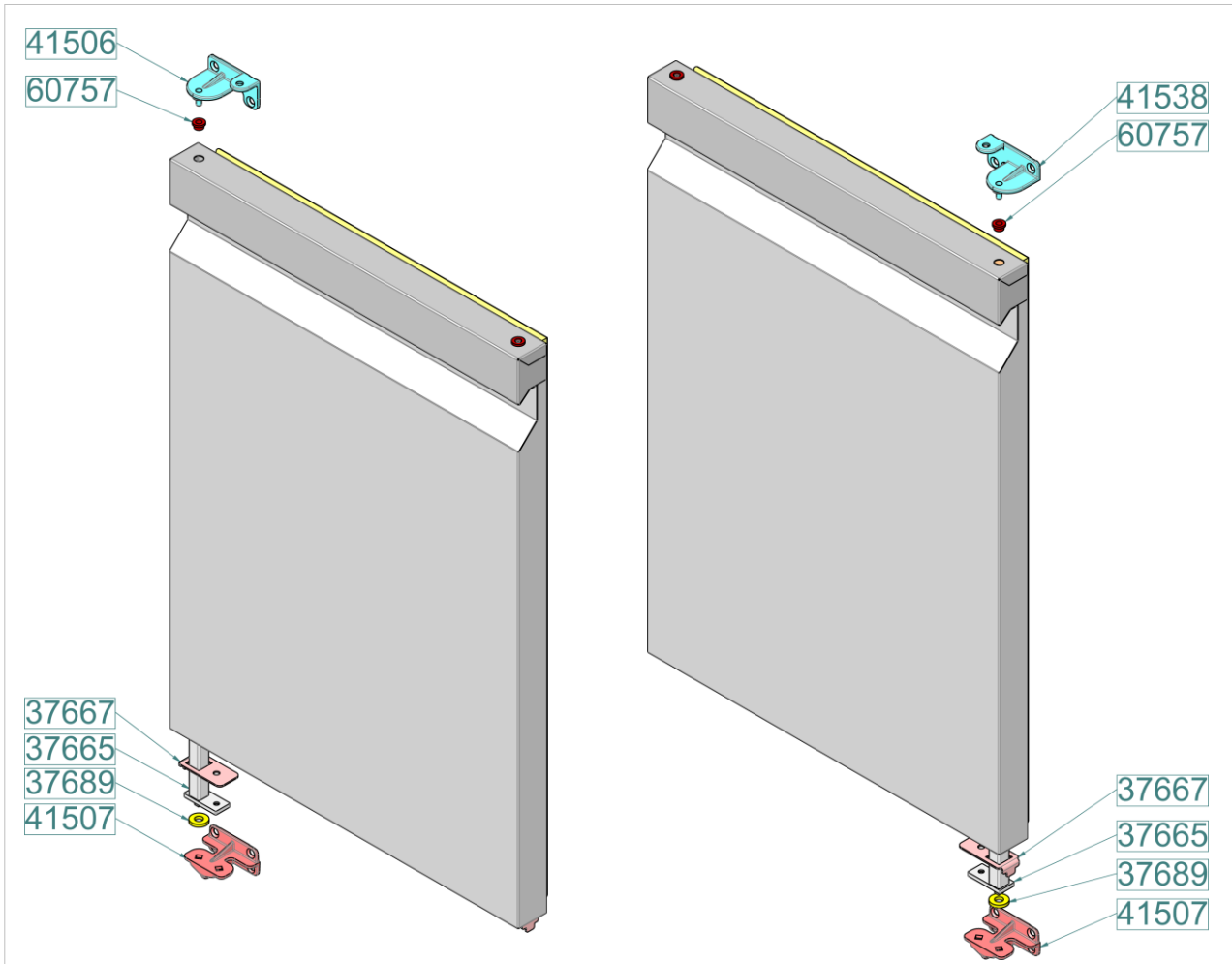



11. DISPOSAL OF THE APPLIANCE

 This appliance is marked in compliance with the 2002/96/EC European Directive, WASTE ELECTRICAL AND ELECTRONIC EQUIPMENT (WEEE).

 By assuring that this product is disposed of correctly, the user contributes to preventing the potential negative consequences on the environment and health.

The improper disposal of Waste Electrical and Electronic Equipment is liable to punishment under the relevant laws in the countries where the offence is committed.

Waste electrical and Electronic Equipment may contain hazardous substances with potential harmful effects on the environment and human health. You are urged to dispose of them properly.

 The  symbol found on the product or on the accompanying documentation indicates that this product must not be treated as domestic waste but must be taken to suitable collection points for the recycling of electric and electronic appliances.

11.1. Waste storage

At the end of the product life, avoid release to the environment.

Temporary storage of special waste is permitted while waiting for disposal by treatment and/or final collection. Dispose of special waste in accordance with the laws in force with regard to protection of the environment in the country of the user.

 For further information regarding the treatment, recovery and recycling of this product, contact the relevant local office, the domestic waste collection service or the shop where the product was purchased.

11.2. Equipment disassembly procedure

 Dismantling operations should be carried out by qualified personnel.

 If the equipment uses R290 cooling gas, every possible precaution must be taken to avoid any danger linked to the flammability of this gas.

 The doors should be removed before disposal.

 Make the appliance totally unusable by removing the power cable and any door locking mechanisms in order to avoid the risk of anyone being trapped inside.

 If the equipment uses R452A, R134a refrigerant or other greenhouse gas (Fgas), it is mandatory to recover and dispose of the refrigerant as prescribed in the country of destination of the equipment.

 Dismantle the refrigerator grouping together the components according to their chemical nature. The compressor contains lubricating oil and refrigerant, which may be recycled. The refrigerator components are considered special waste, which can be assimilated with domestic waste.

12. TECHNICAL DATA SHEET OF REFRIGERANT R134a/R452A

Below is the chemical formula of the fluid **R134a**:

Name	Chemical Formula
HFC-134a	CH ₂ FCF ₃

Below are the components of fluid **R452A**:

Name	%	Chemical Formula
HFC-125	59%	C ₂ HF ₅
HFC-1234yf	30%	C ₃ H ₂ F ₄
HFC-32	11%	CH ₂ F ₂

IDENTIFICATION OF DANGERS

The rapid evaporation of the liquid can cause freezing. The inhalation of high concentrations of vapour can cause irregular heartbeat, short-term narcotic effects (including vertigo, headache and mental confusion), fainting and death.

Effects on the eyes: Freezing or cold burns caused by contact with the liquid.

Effects on the skin: Freezing or cold burns caused by contact with the liquid.

Effects of ingestion the ingestion is not considered means of exposure.

FIRST AID

Eyes: In the case of contact, wash the eye well using a large amount of water for at least 15 minutes. Consult a doctor.

Effects on the skin: Wash with water for at least 15 minutes after excessive contact. If necessary, cure freezing by gently warming the area in question. Consult a doctor in the case of irritation.

Ingestion: Ingestion is not considered means of exposure.

Inhalation: If large concentrations are inhaled, go into the open air. Keep the person calm. If the person cannot breath, perform artificial respiration. If breathing is difficult, apply oxygen. Consult a doctor.

13. TECHNICAL DATA SHEET OF REFRIGERANT R290

Name	Chemical Formula
HC-290	CH ₃ CH ₂ CH ₃

IDENTIFICATION OF DANGERS

- Extremely flammable
- Liquefied gas



GHS02



GHS04

FIRST AID

Inhalation: The intervention of a doctor is recommended. At high concentrations, it can cause asphyxia. Symptoms may include loss of mobility and/or consciousness. Symptoms may include dizziness, headache, nausea and loss of coordination.

Move the victim to an uncontaminated area wearing self-contained breathing apparatus. Keep the patient relaxed and warm. Perform artificial respiration if breathing stops.

Skin and eyes contact: Wash with water for at least 15 minutes. Remove contaminated clothes

Ingestion: No action is necessary. Ingestion is not considered a means of exposure.

FIRE PREVENTION MEASURES:

Suitable extinguishing media:

Water spray, Dry powder.

NON-Suitable extinguishing media:

DO NOT use water jets to extinguish.

Carbon dioxide (CO₂).



Recommendations:

DO NOT extinguish an inflamed gas leak unless absolutely necessary; an explosive re-ignition may occur.