



MOD : CUB50/25A

Production code : 39711S11QZ1856 - CB 425A HC NEW B-QUBE

01/2026

SCHEMA ELETTRICO / WIRING DIAGRAM / ESQUEMA ELÉCTRICO

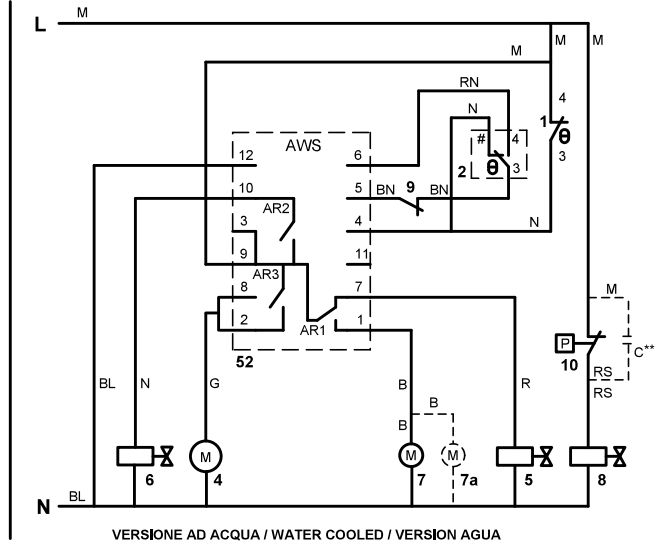
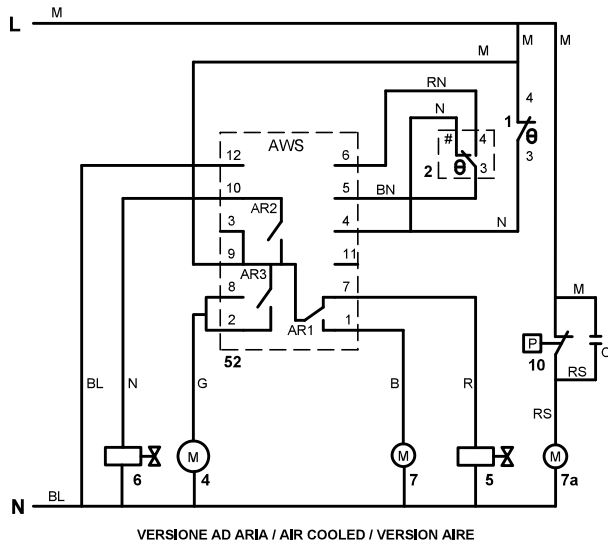

1. TERMOSTATO CONTENITORE BIN THERMOSTAT TERMOSTATO CONTENEDOR	9. TERMOSTATO DI SICUREZZA SAFETY THERMOSTAT TERMOSTATO DE SEGURIDAD
2.* TERMOSTATO EVAPORATORE EVAPORATOR THERMOSTAT TERMOSTATO EVAPORADOR	10. PRESSOSTATO PRESSURE SWITCH PRESOSTATO
4. COMPRESSORE COMPRESSOR COMPRESOR	52. TEMPORIZZATORE ELETTRONICO ELECTRONIC TIMER TEMPORIZADOR ELECTRONICO
5. ELETTROVALVOLA GAS CALDO HOT GAS VALVE ELECTROVALVULA GAS CALIENTE	C. CONDENSATORE CAPACITOR CAPACITADOR
6. ELETTROVALVOLA INGRESSO ACQUA P ER EVAPORATORE WATER INLET VALVE FOR EVAPORATOR VALVÚLA INGRESO AGUA EVAPORADOR	** ONLY: @ 220V / 50HZ @ 220V / 60HZ
7. POMPA PUMP BOMBA	B = BIANCO / WHITE / BLANCO BL = BLU / BLUE / AZUL BN = BIANCO-NERO / WHITE-BLACK / BLANCO-NEGRO G = GRIGIO / GREY / GRIS M = MARRONE / BROWN / MARRON N = NERO / BLACK / NEGRO R = ROSSO / RED / ROJO RN = ROSSO-NERO / RED-BLACK / ROJO-NEGRO RS = ROSA / PINK / ROSA
7a. MOTOVENTILATORE FAN MOTOR MOTOR VENTILADOR	
8. ELETTROVALVOLA INGRESSO ACQUA PER CONDENSATORE WATER INLET VALVE FOR CONDENSER VALVÚLA INGRESO AGUA EVAPORADOR	* RANCO K22: # = 2 DANFOSS 077B: # = 6