



MOD : PEB90/20A

Production code : TB 852A HC

01/2026

SCHEMA ELETTRICO / WIRING DIAGRAM / ESQUEMA ELÉCTRICO

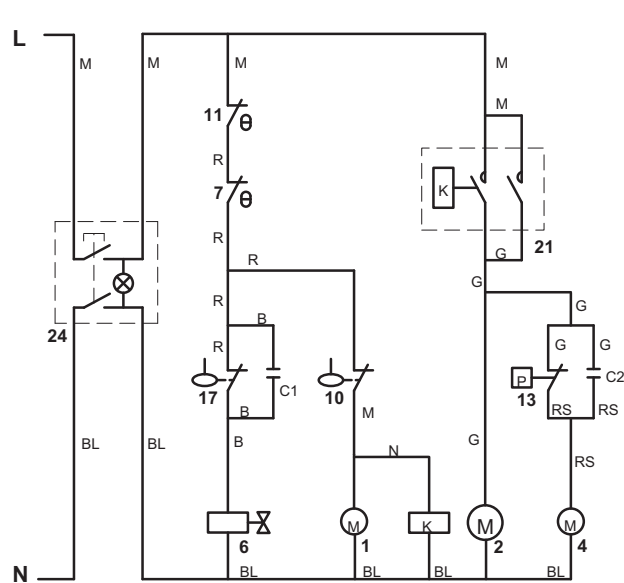

VERSIONE AD ARIA / AIR COOLED / VERSIÓN AIRE

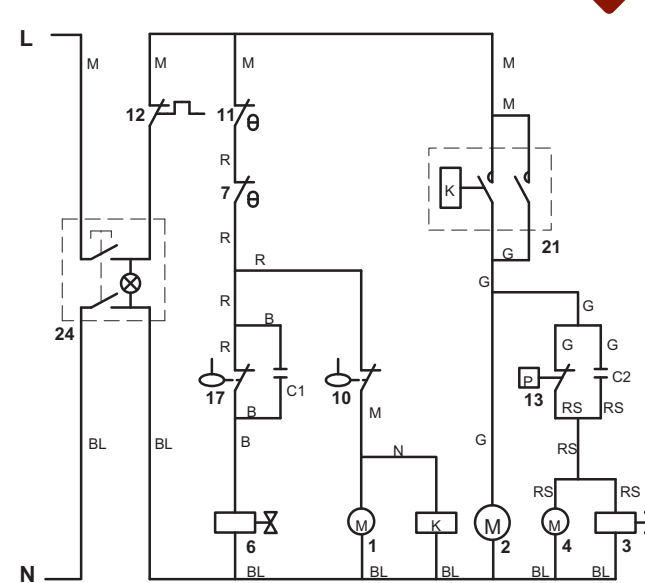

VERSIONE AD ACQUA / WATER COOLED / VERSIÓN AGUA

1. MOTORIDUTTORE GEARMOTOR MOTOREDUCTOR	12. TERMOSTATO DI SICUREZZA CONDENSATORE CONDENSER SAFETY THERMOSTAT TERMOSTATO DE SEGURIDAD CONDENSADOR
2. COMPRESSORE COMPRESSOR COMPRESSOR	13. PRESSOSTATO CONDENSAZIONE CONDENSER PRESSURE SWITCH PRESOSTATO CONDENSACION
3. VALVOLA ACQUA CONDENSAZIONE CONDENSER WATER VALVE VÁLVULA AGUA POR CONDENSACION	17. MICRO LIVELLO ACQUA BACINELLA BASIN WATER LEVEL MICRO SWITCH MICRO NIVEL AGUA BACÍA
4. MOTOVENTILATORE FAN MOTOR MOTOVENTILADOR	21. RELE' RELAY RELÉ
6. VALVOLA ACQUA BACINELLA BASIN WATER VALVE VÁLVULA AGUA BACÍA	24. INTERRUTTORE ON-OFF ON-OFF SWITCH INTERRUPTOR ON-OFF
7. TERMOSTATO DI SICUREZZA EVAPORATORE EVAPORATOR SAFETY THERMOSTAT TERMOSTATO DE SEGURIDAD EVAPORADOR	B = BIANCO / WHITE / BLANCO BL = BLU / BLUE / AZUL G = GRIGIO / GREY / GRIS M = MARRONE / BROWN / MARRÓN N = NERO / BLACK / NEGRO R = ROSSO / RED / ROJO RS = ROSA / PINK / ROSA
10. MICRO MANCANZA ACQUA BACINELLA BASIN WATER LACK MICRO SWITCH MICRO FALTA DE AGUA BACÍA	
11. TERMOSTATO CONTENITORE BIN THERMOSTAT TERMOSTATO CONTENIDOR	