



**MOD: SGBT/20S**

**Production code : 228708**

**01/2026**

# Electrical and Gas Oven

## Combi DIGITAL models



---

EN User manual \*

\*Original instructions



595407Z00\_SW-1.10- 2025.09

## Foreword

 Read the following instructions, including the warranty terms before installing and using the appliance.

---

 Register your product

 Get hints & tips of your product, service and repair information

---

The installation, use and maintenance manual (hereinafter Manual) provides the user with information necessary for correct and safe use of the appliance.

The following must not be considered a long and exacting list of warnings, but rather a set of instructions suitable for improving appliance performance in every respect and, above all, preventing injury to persons and animals and damage to property due to improper operating procedures.

All persons involved in appliance transport, installation, commissioning, use and maintenance, repair and disassembly must consult and carefully read this manual before carrying out the various operations, in order to avoid wrong and improper actions that could compromise the appliance's integrity or endanger people. Make sure to periodically inform the user regarding the safety regulations. It is also important to instruct and update personnel authorised to operate on the appliance, regarding its use and maintenance.

The manual must be available to operators and carefully kept in the place where the appliance is used, so that it is always at hand for consultation in case of doubts or whenever required.

If, after reading this manual, there are still doubts regarding appliance use, do not hesitate to contact the Manufacturer or the authorised Service Centre to receive prompt and precise assistance for better operation and maximum efficiency of the appliance. During all stages of appliance use, always respect the current regulations on safety, work hygiene and environmental protection. It is the user's responsibility to make sure the appliance is started and operated only in optimum conditions of safety for people, animals and property.



### IMPORTANT

- The manufacturer declines any liability for operations carried out on the appliance without respecting the instructions given in this manual.
- The manufacturer reserves the right to modify the appliances presented in this publication without notice.
- No part of this manual may be reproduced.
- This manual is available in digital format by:
  - contacting the dealer or reference customer care;
  - downloading the latest and up to date manual on the web site
- The manual must always be kept in an easily accessed place near the appliance. Appliance operators and maintenance personnel must be able to easily find and consult it at any time.

# Contents

A	WARNING AND SAFETY INFORMATION	5
A.1	General information	5
A.2	Personal protection equipment	5
A.3	General safety	6
A.4	Protection devices installed on the appliance	7
A.5	Safety signs to be placed on the appliance or near its area	7
A.6	Reasonably foreseeable improper use	7
A.7	Residual risks	7
A.8	Appliance cleaning	8
A.9	Preventive Maintenance	8
A.10	Parts and accessories	8
A.11	Precautions for use and maintenance	8
A.12	Appliance maintenance	8
B	WARRANTY	9
B.1	Warranty terms and exclusions	9
C	GENERAL INFORMATION	9
C.1	Introduction	9
C.2	Intended use and restrictions	9
C.3	Testing and inspection	9
C.4	Copyright	9
C.5	Keeping the manual	9
C.6	Recipients of the manual	9
C.7	Definitions	10
C.8	Responsibility	10
D	NORMAL APPLIANCE USE	10
D.1	Characteristics of personnel enabled to operate on the appliance	10
D.2	Basic requirements for appliance use	10
E	PRODUCT DESCRIPTION	11
E.1	Appliance overview	11
E.2	Use – Introduction	11
E.3	Opening and closing the oven door	12
E.4	Control panel	13
F	OPERATING	13
F.1	Switch the oven ON	13
F.2	Displays and controls description	14
F.3	Oven connectivity	15
F.4	Cooking cycle setting	16
F.4.1	Select the required COOKING CYCLE	16
F.4.2	Set the HUMIDITY	16
F.4.3	Set the TEMPERATURE	16
F.4.4	Set the cooking TIME	16
F.4.5	Preheating/Cooling phase	16
F.4.6	Stop cycle	16
F.4.7	End cycle	16
F.4.8	FUNCTIONS & OPTIONS	17
F.5	Programs	18
F.6	Indicator Lights	19
F.7	Special functions	19
F.8	HOOD MANAGEMENT	20
F.9	Cleaning cycles	20
F.9.1	Set a cleaning cycle	20
F.9.2	Available cleaning cycles	20
F.9.3	Start the cycle	20
F.9.4	Cleaning cycle information on displays	21
F.9.5	Detergents	21
F.9.6	Detergent loading	22
F.9.7	Precautions	22
F.9.8	FORCED CLEANING	23
F.9.9	Boiler descaling (dESC cycle)	23
F.10	SWITCH THE OVEN OFF	23
G	APPLIANCE CLEANING	23
G.1	Care information	23
G.2	Cleaning introduction	23
G.3	Appliance cleaning	24
G.4	Cooking chamber (cavity)	24
G.5	Boiler or steam generator (models equipped only)	24
G.6	Cooking chamber filter	24
G.7	Air filter	24
G.8	Door gasket	24
G.9	Inner glass doors and cooking chamber glass	25
G.10	Door area	25
G.11	Efficiency control of the discharge system	26

G.12	Condensate drip collector .....	26
G.13	Food probe .....	26
G.14	Other surfaces .....	26
G.15	Periods of non-use.....	26
G.16	Replacing wear and tear components .....	26
G.17	Repair and extraordinary maintenance .....	27
G.18	Maintenance intervals.....	27
G.19	Maintenance contacts (only for Australia).....	27
H	TROUBLESHOOTING .....	27
H.1	Introduction .....	27
H.2	Error codes .....	27
I	FURTHER INFORMATION .....	39
I.1	Ergonomic features.....	39
I.1.1	Certification .....	39
I.1.2	General recommendations .....	39

## A WARNING AND SAFETY INFORMATION

### A.1 General information

To ensure safe use of the appliance and a proper understanding of the manual it is necessary to be familiar with the terms and typographical conventions used in the documentation. The following symbols are used in the manual to indicate and identify the various types of hazards:



#### WARNING

Danger for the health and safety of operators.



#### WARNING

Danger of electrocution - dangerous voltage.



#### CAUTION

Risk of damage to the appliance or the product.



#### IMPORTANT

Important instructions or information on the product



Equipotentiality



Read the instructions before using the appliance



Clarifications and explanations

- Incorrect installation, servicing, maintenance, cleaning or modifications to the unit may result in damage, injury or death.
- Only specialised personnel are authorised to operate on the appliance.
- This appliance is to be intended for commercial and collective use, for example in kitchens of restaurants, canteens, hospitals and in commercial enterprises such as bakeries, butcheries, etc., not for continuous mass production of food. Any other use is deemed improper.
- This appliance must not be used by minors and adults with limited physical, sensory or mental abilities or without adequate experience and knowledge regarding its use.
- For your safety do not store or use gasoline or other flammable materials, vapours and liquids in the vicinity of this or any other appliance.
- Do not store explosive substances, such as pressurized containers with flammable propellant, in this appliance.
- Refer to the data given on the appliance's data plate for relations with the Manufacturer (e.g. when ordering spare parts, etc.).
- When scrapping the appliance, the marking CE must be destroyed.
- Save these instructions carefully for further consultation by the various operators.

### A.2 Personal protection equipment

Summary table of the Personal Protection Equipment (PPE) to be used during the various stages of the appliance's service life.

Stage	Protective garments 	Safety footwear 	Gloves 	Glasses 	Safety helmet 
Transport	—	●	○	—	○
Handling	—	●	○	—	—
Unpacking	—	●	○	—	—
Installation	—	●	● <sup>1</sup>	—	—
Normal use	●	●	● <sup>2</sup>	—	—
Adjustments	○	●	—	—	—
Routine cleaning	○	●	● <sup>1-3</sup>	○	—
Extraordinary cleaning	○	●	● <sup>1-3</sup>	○	—
Maintenance	○	●	○	—	—
Dismantling	○	●	○	○	—
Scrapping	○	●	○	○	—

Stage	Protective garments	Safety footwear	Gloves	Glasses	Safety helmet
					
<b>Key:</b>					
●	<b>PPE REQUIRED</b>				
○	<b>PPE AVAILABLE OR TO BE USED IF NECESSARY</b>				
—	<b>PPE NOT REQUIRED</b>				

1. During these operations, gloves must be cut-resistant. Failure to use the personal protection equipment by operators, specialized personnel or users can involve exposure to harm to health (depending on the model).
2. During these operations, gloves must be heatproof to protect hands from contact with hot food or hot parts of the appliance and/or when removing hot items from it. Failure to use the personal protection equipment by operators, specialised personnel or users can involve exposure to chemical risk and cause possible harm to health (depending on the model).
3. During these operations, gloves must be suitable for contact with chemical substances used (refer to the safety data sheet of the substances used for information regarding the required PPE). Failure to use the personal protection equipment by operators, specialized personnel or users can involve exposure to chemical risk and cause possible harm to health (depending on the model).

### A.3 General safety

- The appliances are provided with electric and/or mechanical safety devices for protecting workers and the appliance itself.
- Never operate the appliance, removing, modifying or tampering with the guards, protection or safety devices.
- Do not make any modifications to the parts supplied with the appliance.
- Several illustrations in the manual show the appliance, or parts of it, without guards or with guards removed. This is purely for explanatory purposes. Do not use the appliance without the guards or with the protection devices deactivated.

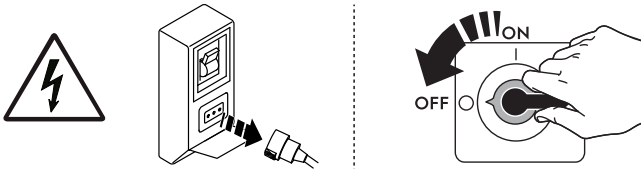

Disconnect the appliance from the power supply before carrying out any installation, assembly, cleaning or maintenance procedure.

- Do not remove, tamper with or make illegible the CE marking, the safety, danger and instruction signs and labels on the appliance.
- The A-weighted emission sound pressure level does not exceed 70 dB(A).
- Do not use products (even if diluted) containing chlorine (sodium hypochlorite, hydrochloric or muriatic acid, etc.) to clean the appliance or the floor under it.
- Carefully avoid exposure of the equipment to ozone - do not use ozonizers in the rooms where the equipment is installed.
- Do not spray aerosols in the vicinity of this appliance while it is in operation.
- Do not place flammable liquids (e.g. spirits) inside the oven during operation.
- Never check for leaks with an open flame.
- For gas models, do not connect the appliances to networks containing gases containing carbon monoxide or other toxic components.
- Install the appliance under conditions of adequate ventilation in order to provide a suitable air change per hour. Make sure that the ventilation system, whatever it is, always remains operational and efficient for the entire period of time during which the equipment is operating.
- If the recirculating (condensation or odourless) hood accessory is used, make sure that the ventilation system, whatever it is, is adequate for the installed power, also in accordance with national and local regulations and provisions on air changes.
- Improper ventilation of the oven can be hazardous to the health of the operator; and will result in operational problems, unsatisfactory cooking results, and possible damage to the equipment. Damage sustained as a direct result of improper ventilation OF THE OVEN will not be covered by the Manufacturer's warranty.
- Do not obstruct the flow of combustion and ventilation air.
- When the oven is operating and hot, always open the door with caution to avoid the risk of sudden ejection of hot air or steam.
- The following operations have to be carried out by specialised authorised personnel or Customer Care Service provided with all the appropriate personal protection equipment (A.2 *Personal protection equipment*), tools, utensils and ancillary means, who can ask the manufacturer to supply a servicing manual:
  - Installation and assembly
  - Positioning
  - Electrical connection
  - Appliance cleaning, repair and extraordinary maintenance
  - Appliance disposal
  - Work on electrical equipment
  - Gas installation/connection and gas conversion;







## A.4 Protection devices installed on the appliance

### Guards

The appliance has:

- fixed guards (e.g. casings, covers, side panels, etc.), fixed to the appliance and/or frame with screws or quick-release connectors that can only be removed or opened with tools; therefore the user must not remove or tamper with such devices. The Manufacturer declines any liability for damage due to tampering or their non-use;
- interlocked movable guards (door) for access inside the appliance;
- appliance electrical equipment access panels or doors, made from hinged panels openable with tools. The panel or the door must not be opened when the appliance is connected to the power supply.

## A.5 Safety signs to be placed on the appliance or near its area

Prohibition	Meaning
	do not remove the safety devices
	do not use water to extinguish fires (placed on electrical parts)
	Keep the area around the appliance clear and free from combustible materials. Do not keep flammable materials in the vicinity of the appliance
Danger	Meaning
	caution hot surface
	danger of electrocution (shown on electrical parts with indication of voltage)
	risk of scalding

## A.6 Reasonably foreseeable improper use

Improper use is any use different from that specified in this manual. During appliance operation, other types of work or activities deemed improper and that in general can involve risks for the safety of operators and damage to the appliance are not allowed. Reasonably foreseeable improper use includes:

- lack of appliance maintenance, cleaning and periodical checks;
- structural changes or modifications to the operating logic;
- tampering with the guards or safety devices;
- failure to use personal protection equipment by operators, specialised personnel and maintenance personnel;
- failure to use suitable accessories (e.g. use of unsuitable equipment or ladders);
- keeping combustible or flammable materials, or in any case materials not compatible with or pertinent to the work, near the appliance;
- wrong appliance installation;
- placing in the appliance any objects or things not compatible with its use, or that can damage the appliance, cause injury or pollute the environment;
- climbing on the appliance;
- non-compliance with the requirements for correct appliance use;
- other actions that give rise to risks not eliminable by the Manufacturer.

## A.7 Residual risks

The appliance has several risks that were not completely eliminated from a design standpoint or with the installation of adequate protection devices. Nevertheless, through this manual the Manufacturer has taken steps to inform operators of such risks, carefully indicating the personal protection equipment to be used by them. In order to reduce the risks, provide for sufficient spaces while installing the unit.

To preserve these conditions, the areas around the appliance must always be:

- kept free of obstacles (e.g. ladders, tools, containers, boxes, etc.);
- clean and dry;

- well lit.

For the Customer's complete information, the residual risks remaining on the appliance are indicated below: such actions are deemed improper and therefore strictly forbidden.

Residual risk	Description of hazardous situation
Slipping or falling	The operator can slip due to water, any liquid or dirt on the floor
Burns/abrasions (e.g. heating elements, cold pan, cooling circuit plates and pipes)	The operator deliberately or unintentionally touches some components inside the appliance without using protective gloves.
Electrocution	Contact with live parts during maintenance operations carried out with the electrical panel powered
Falling from above	The operator intervenes on the appliance using unsuitable systems to access the upper part (e.g. rung ladders, or climbs on it)
Crushing or injury	The specialised personnel may not correctly fix the control panel when accessing the technical compartment. The panel could close suddenly.
Tipping of loads	When handling the appliance or the packing containing it, using unsuitable lifting systems or accessories or with the unbalanced load
Chemical	Contact with chemical substances (e.g. detergent, rinse aid, scale remover, etc.) without taking adequate safety precautions. Therefore always refer to the safety cards and labels on the products used.
Sudden closure	The operator for normal appliance use could suddenly and deliberately close the lid/door/oven door (if present, depending on the appliance type).

## A.8 Appliance cleaning



### IMPORTANT

In order to maintain the appliance performance and safeness, the appliance shall be maintained and cleaned.

- Do not touch the appliance with wet hands or feet or when barefoot.
- Use a ladder with suitable protection for work on appliances with high accessibility.
- Put the appliance in safe conditions before starting any cleaning operation.
- Respect the requirements for the various routine and extraordinary maintenance operations. Non-compliance with the instructions can create risks for personnel.
- Do not spray water or use water jets, steam cleaner or high pressure cleaner.

## A.9 Preventive Maintenance

In order to ensure the safety and performance of your equipment, it is recommended that service is undertaken by authorised engineers every 12 months, in accordance with Service Manuals. Please contact your local Service Centre for further details.

## A.10 Parts and accessories

Use only original accessories and/or spare parts. Failure to use original accessories and/or spare parts will invalidate the original manufacturer warranty and may render the appliance not compliant with the safety standard.

## A.11 Precautions for use and maintenance

- Risks mainly of a mechanical, thermal and electrical nature exist in the appliance. Where possible the risks have been neutralised:
  - directly, by means of adequate design solutions.
  - indirectly by using guards, protection and safety devices.
- Any anomalous situations are signalled on the control panel display.
- During maintenance several risks remain, as these could not be eliminated, and must be neutralised by adopting specific measures and precautions.
- Do not carry out any checking, cleaning, repair or maintenance operations on moving parts. Workers must be informed of this prohibition by means of clearly visible signs.
- Make sure to periodically check correct operation of all the safety devices and the insulation of electrical cables, which must be replaced if damaged.

In case of a significant anomaly (e.g. short circuits, wires coming out of the terminal block, motor breakdowns, worn electrical cable sheathing, etc.) the operator for normal appliance use must:

- immediately deactivate the appliance and disconnect all the supplies (electricity, gas, water).

Before carrying out any operation on the appliance, always consult the manual which gives the correct procedures and contains important information on safety.

## A.12 Appliance maintenance

- The inspection and maintenance intervals depend on the actual appliance operating conditions and ambient conditions (presence of dust, damp, etc.), therefore precise time intervals cannot be given. In any case, careful and periodical appliance maintenance is advisable in order to minimise service interruptions.
- It is advisable to stipulate a preventive and scheduled maintenance contract with the Customer Care Service.
- Put the appliance in safe conditions before starting any maintenance operation.

- To guarantee appliance efficiency and correct operation, periodical maintenance must be carried out according to the instructions given in the manual.

## B WARRANTY

### B.1 Warranty terms and exclusions

If the purchase of this product includes warranty coverage, warranty is provided in line with local regulations and subject to the product being installed and used for the purposes as designed, and as described within the appropriate equipment documentation.

Warranty will be applicable where the customer has used only genuine spare parts and has performed maintenance in accordance with user and maintenance documentation made available in paper or electronic format.

strongly recommends using approved cleaning, rinse and descaling agents to obtain optimal results and maintain product efficiency over time.

The warranty does not cover:

- service trips cost to deliver and pick up the product;
- installation;
- training on how to use/operate;
- replacement (and/or supply) of wear and tear parts unless resulting from defects in materials or workmanship reported within one (1) week from the failure;
- correction of external wiring;
- correction of unauthorized repairs as well as any damages, failures and inefficiencies caused by and/or resulting from:
  - insufficient and/or abnormal capacity of the electrical systems (current/voltage/frequency, including spikes and/or outages);
  - inadequate or interrupted water supply, steam, air, gas (including impurities and/or other that does not comply with the technical requirements for each appliance);
  - plumbing parts, components or consumable cleaning products that are not approved by the manufacturer;
- customer's negligence, misuse, abuse and/or non-compliance with the use and care instructions detailed within the appropriate equipment documentation;
- improper or poor: installation, repair, maintenance (including tampering, modifications and repairs carried out by third parties not authorized) and modification of safety systems;
- Use of non-original components (e. g.: consumables, wear and tear, or spare parts);
- environment conditions provoking thermal (e. g. overheating/freezing) or chemical (e. g. corrosion/oxidation) stress;
- foreign objects placed in- or connected to- the product;
- accidents or force majeure;
- transportation and handling, including scratches, dents, chips, and/or other damage to the finish of the product, unless such damage results from defects in materials or workmanship and is reported within one (1) week of delivery unless otherwise agreed;
- product with original serial numbers that have been removed, altered or cannot be readily determined;
- replacement of light bulbs, filters or any consumable parts;
- any accessories and software not approved or specified by

**warranty will be void and manufacturer shall have no liability related thereto in case of any modification of the product or related hardware/software/programming.**

Warranty does not include scheduled maintenance activities (including the parts required for it) or the supply of cleaning agents unless specifically covered within any local agreement, subject to local terms and conditions.

Check on website the list of authorized customer care.

## C GENERAL INFORMATION



### WARNING

Refer to "*WARNING and Safety Information*".

### C.1 Introduction

This manual contains information relevant to various appliances. The product images in this guide are only an example.

The drawings and diagrams given in the manual are not in scale. They supplement the written information with an outline, but are not intended to be a detailed representation of the appliance supplied.

The numerical values given on the appliance installation diagrams refer to measurements in millimeters and/or inches.

### C.2 Intended use and restrictions

This appliance is designed for cooking food. It is intended for collective use.

Any other use is deemed improper.



#### NOTE!

The manufacturer declines any liability for improper use of the product.

### C.3 Testing and inspection

Our appliances have been designed and optimized, with laboratory testing, in order to obtain high performance and efficiency.



### IMPORTANT

For 20 grids models only: the oven shall be used with the supplied trolley or with the appropriate ones listed in the accessory catalogue.

The appliance is shipped ready for use.

Passing of the tests (visual inspection - gas/electrical test - functional test) is guaranteed and certified by the specific enclosures.

### C.4 Copyright

This manual is intended solely for consultation by the operator and can only be given to third parties with the permission of

### C.5 Keeping the manual

The manual must be carefully kept for the entire life of the appliance, until scrapping. The manual must stay with the appliance in case of transfer, sale, hire, granting of use or leasing.

### C.6 Recipients of the manual

**This manual is intended for:**

- the employer of appliance users and the workplace manager;
- operators for normal appliance use;
- specialised personnel - Customer Care service (see service manual).

## C.7 Definitions

Listed below are the definitions of the main terms used in the manual. It is advisable to read them carefully before use.

Operator	appliance installation, adjustment, use, maintenance, cleaning, repair and transport personnel.
Operator for normal appliance use	an operator who has been informed and trained regarding the tasks and hazards involved in normal appliance use.
Customer Care service or specialised personnel	an operator instructed/trained by the Manufacturer and who, based on his professional and specific training, experience and knowledge of the accident-prevention regulations, is able to appraise the operations to be carried out on the appliance and recognise and prevent any risks. His professionalism covers the mechanical, electrotechnical and electronics fields etc.
Danger	source of possible injury or harm to health.
Hazardous situation	any situation where an operator is exposed to one or more hazards.
Risk	a combination of probabilities and risks of injury or harm to health in a hazardous situation.
Protection devices	safety measures consisting of the use of specific technical means (guards and safety devices) for protecting operators against risks.
Guard	an element of a appliance used in a specific way to provide protection by means of a physical barrier.
Safety device	a device (other than a guard) that eliminates or reduces the risk; it can be used alone or in combination with a guard.

Customer	the person who purchased the appliance and/or who manages and uses it (e. g. company, entrepreneur, firm).
Electrocution	an accidental discharge of electric current on a human body.

## C.8 Responsibility

**The Manufacturer declines any liability for damage and malfunctioning caused by:**

- non-compliance with the instructions contained in this manual;
- repairs not carried out in a workmanlike fashion, and replacements with parts different from those specified in the spare parts catalogue (the fitting and use of non-original spare parts and accessories can negatively affect appliance operation and invalidates the original manufacturer warranty);
- operations carried out by non-specialised personnel;
- unauthorized modifications or operations;
- missing, lack or inadequate maintenance;
- improper appliance use;
- unforeseeable extraordinary events;
- use of the appliance by uninformed and / or untrained personnel;
- non-application of the current provisions in the country of use, concerning safety, hygiene and health in the workplace.

The Manufacturer declines any liability for damage caused by arbitrary modifications and conversions carried out by the user or the Customer.

The employer, workplace manager or service technician are responsible for identifying and choosing adequate and suitable personal protection equipment to be worn by operators, in compliance with regulations in force in the country of use.

The Manufacturer declines any liability for inaccuracies contained in the manual, if due to printing or translation errors.

Any supplements to the installation, use and maintenance manual the Customer receives from the Manufacturer will form an integral part of the manual and therefore must be kept together with it.

## D NORMAL APPLIANCE USE

### D.1 Characteristics of personnel enabled to operate on the appliance

The Customer must make sure the personnel for normal appliance use are adequately trained and skilled in their duties.

The operator must:

- read and understand the manual;
- receive adequate training and instruction for their duties in order to operate safely;
- receive specific training for correct appliance use.



#### **IMPORTANT**

The Customer must make sure his personnel have understood the instructions received and in particular those regarding work hygiene and safety in use of the appliance.

### D.2 Basic requirements for appliance use

- Knowledge of the technology and specific experience in operating the appliance.
- Adequate general basic education and technical knowledge for reading and understanding the contents of the manual, including correct interpretation of the drawings, signs and pictograms.
- Sufficient technical knowledge for safely performing his duties as specified in the manual.
- Knowledge of the regulations on work hygiene and safety.

## E PRODUCT DESCRIPTION

### E.1 Appliance overview

6 -10 GN model

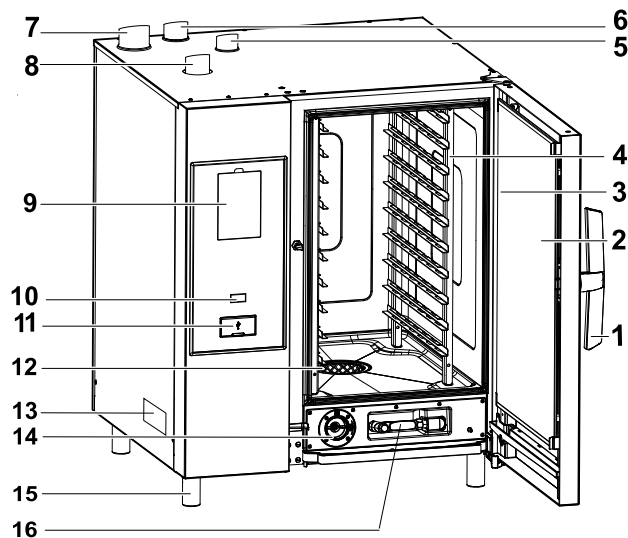

20 GN model

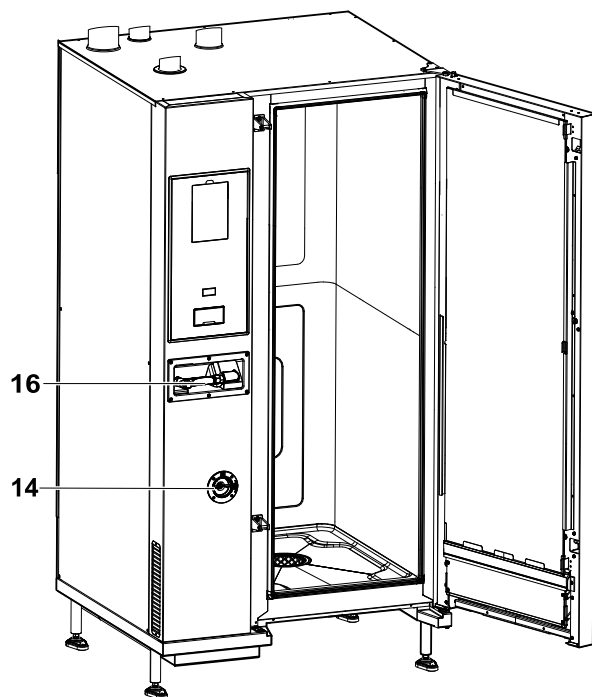

1. Door handle (shape depending on the model)
2. Triple glass door
3. Led bar for lighting cavity
4. Grids support
5. Exhaust gas cavity heat exchanger (all gas models)
6. Steam discharge (electric and gas models)
7. Exhausting gas from steam generator (gas models with boiler)
8. Air inlets (electric and gas models)
9. Control panel – display

10. ON/OFF button
11. USB pendrive port
12. Cavity filter – housing for detergent tabs (cavity washing)
13. Data plate
14. Descaling/rinse agent drawer
15. Feet
16. Hand spray cleaning unit, if present in your model



#### NOTE!

The hand spray only works if the oven is switched on.

### E.2 Use – Introduction

The instructions and information given in this manual are important for correct and optimum oven use. If required, further details regarding its characteristics and cooking performance can be obtained from the dealer.

- To avoid obstructing the fume and steam discharge pipes, do not place pans or utensils of any kind on the oven.
- Do not place objects (e.g. pans) under the bottom of the oven, so as not to obstruct any cooling air inlet or outlet holes.



#### IMPORTANT

**In 20 Grids models run the cleaning cycles only with trolley inside the oven.** It helps the sealing in closing the bottom openings between the cavity and the door.

- Do not salt food inside the oven, in particular with humid cycles.
- Do not place flammable liquids (e.g. spirits) inside the oven during operation.



#### IMPORTANT

After the installation of 6, 10 and 20 grids ovens (stacking installation included) is carried out, check at which height the upper trays are placed in the oven. If required, place the following sticker (supplied) on the front of the oven and **at a height of 1,60 m or higher above the floor.**



#### CAUTION

To avoid scaldings, do not use recipients containing liquids (or products that become liquid with cooking) in shelves positioned at levels higher than 1,6 m above the floor. This is to prevent spilling during handling.

## Food loading on oven

No. of grids		MODELS					
		6 GN 1/1	6 GN 2/1	10 GN 1/1	10 GN 2/1	20 GN 1/1	20 GN 2/1
Maximum oven load	Kg	30	60	50	100	100	200
Maximum pan/tray load	Kg	15	30	15	30	15	30

### Ovens 20 GN 2/1 Electric models only

To obtain a better cooking performance during cooking cycle insert the accessory "panel deflector" over the first rack of the trolley (refer to the picture below - PNC accessory: 922445)



#### IMPORTANT

The supplied panel deflector must be removed from the trolley during **cleaning cycle**.

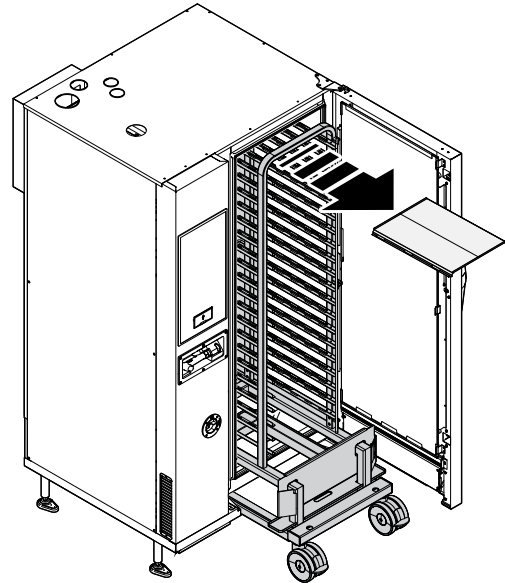
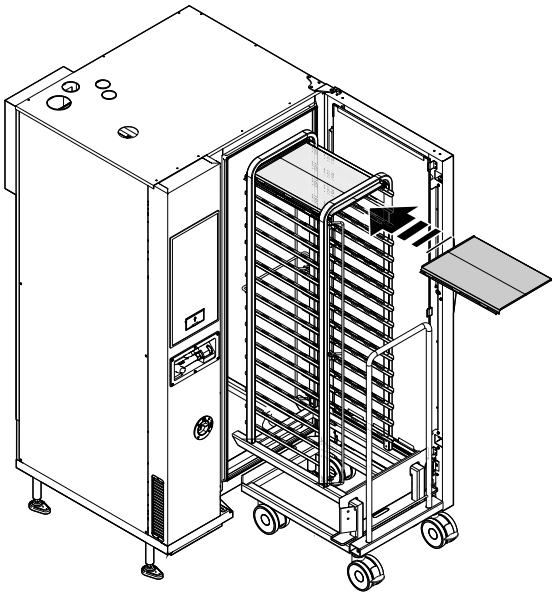

## E.3 Opening and closing the oven door

Below the instructions for closing and opening the oven door, model by model.

### 6 GN and 10 GN Model

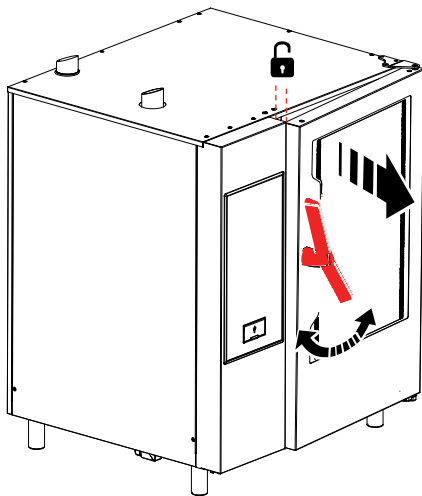

1. Turn the door handle clockwise or counterclockwise all the way to fully open the oven door. The cooking cycle is stopped, if in progress.
2. To close the door press it against the oven enough to lock it.

### 20 GN Model

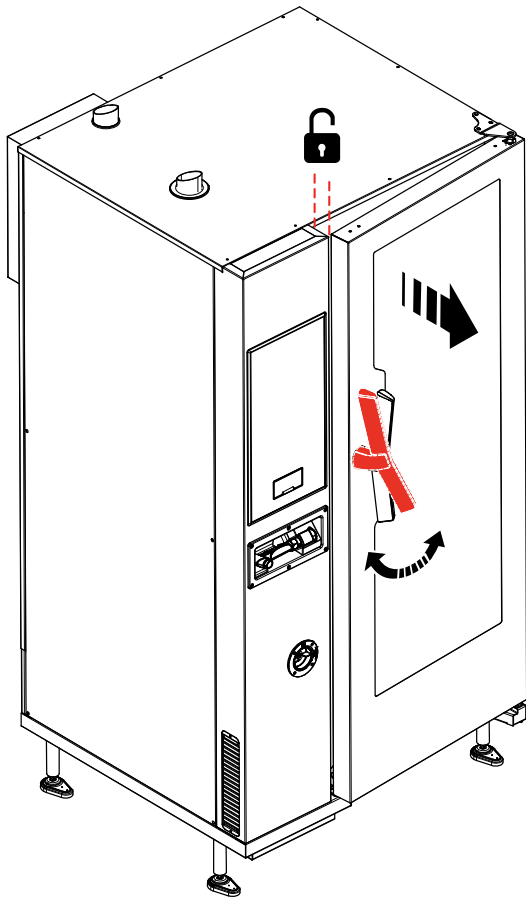

1. Rotate the handle by 90°C counterclockwise to open the door completely. The cooking programme is stopped, if in progress.
2. For closing rotate the handle by 90°C counterclockwise until it stops and bring the door against the oven.
3. Keeping the door pressed against the oven, rotate the handle back in its vertical position to complete its locking.

#### E.4 Control panel



### WARNING

Refer to “*WARNING and Safety Information*”.

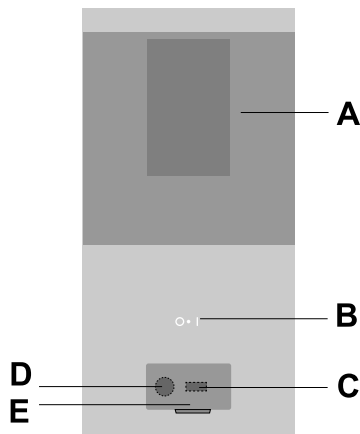

- A. Digital panel
- B. ON/OFF button
- C. USB key in/out
- D. Connection for accessory
- E. Openable flap

## F OPERATING

### F.1 Switch the oven ON

Press the “I” side of the button “O – I” to switch the oven on.

Press the “O” side of the same button to switch the oven off.



#### IMPORTANT

**For gas models only:** wait 5 minutes before relighting.

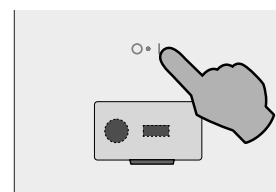

- the corresponding O - I button lights up;
- the control panel switches on; the lower display shows an animation with the software loading while the upper display shows the software release value.

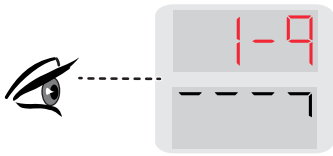

### Switching the oven ON for the first time

The TIME display is lighted up:

- keep pressed the TIME button to set the year, month, day, hours and minutes; on the keypad press the “>” or “<” buttons to move forward or backward to set the required value;  
(Example figure below 12:05)



## F.2 Displays and controls description

The oven allows cooking with different cooking modes according to the type of food and your requirements.

It is possible to set the various modes from the display by pressing the corresponding icon.

### Level B model

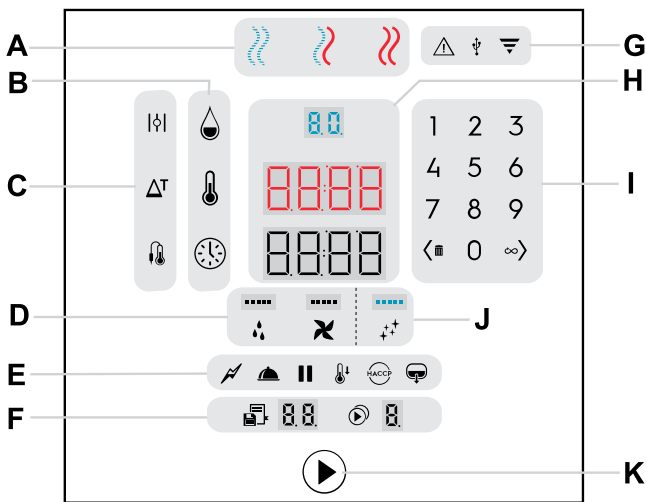

### Level C model (Boilerless)

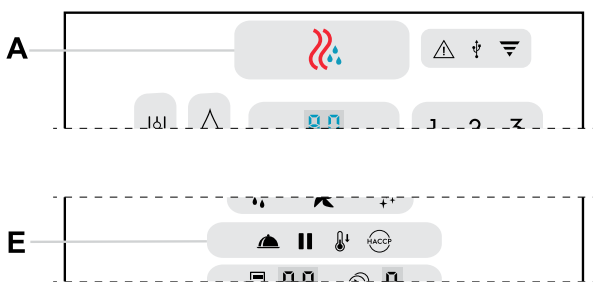

- A. Cooking cycles
- B. Cooking parameters
- C. Cooking options
- D. Special functions
- E. Utilities
- F. Programs and Multiphase
- G. Indicator Lights
- H. Digit displays
- I. Keypad
- J. Cleaning cycles
- K. Start button

### Lights status:

- maximum brightness = active buttons
- minimum brightness = inactive buttons
- without brightness = buttons not available

- flashing light = request or warning

### Displays status:

- Displays normally indicate values of humidity, temperature, time, programs and multiphase. They can also show other functions values or words to indicate warnings or actions to be carried out.

### A - Cooking cycles

» **CONVECTION Cycle**  
For roasting and gratinating  
Maximum temperature up to 300 °C.

» in Boilerless models

» **COMBI Cycle** (only in boiler models)  
Superheated steam.  
The steam generator and the cavity are used at the same time to keep foods tender.  
Maximum temperature up to 300°C.

» **STEAM Cycle** (only in boiler models)

- Full Steam: ideal for steaming at 100°C.
- Low temperature steam for gentle cooking, vacuum packed foods and for defrosting (temperature from 25°C to 99°C);
- Superheated steam (temperature from 101°C to 130°C).

### B - Cooking Parameters

» **Humidity**  
It allows to adjust:

- the required humidity level in Combi Cycle.
- the maximum humidity level in Convection Cycle.
- the humidification level from 10 to 100 in Boilerless models.

» **Temperature**  
Digital thermostat for cavity temperature

» **Time**  
Cooking time

### C - Cooking Options

» **Vent Open** (Convection cycle only)  
For very dry cooking, it allows the remove the humidity when necessary (max. temperature 300°C).

» **Eco Delta** (Cooking with food probe cycle only)  
The ECO DELTA function enables cooking without harming the food with high temperatures;  
This is an advanced cooking method, where the oven cavity temperature varies according to the core temperature of the food.

» **Food Probe**  
The food probe allows accurate control of the core temperature of the product being cooked.

### D - Special Functions

» **Water Injection**  
Manual injection of water in cavity: for instantly increasing the humidity level during a cooking cycle.



### Fan

It allows the adjustment of the fan speed.

## E - Utilities



### Reduced Power (only in boiler models)

For gentle cooking, such as light patisserie. Combinable with all cycles.



### Hold

For slow and prolonged cooking, typically for meat (large cuts). Ideal to maintain a warm temperature at the end of cooking. Combinable with all cycles.



### Pause

For setting a pause between cooking cycles.



### Cool Down

Fast cavity cooling: useful to switch from one type of cooking to another at lower temperature.

It enables fan rotation and automatic injection of water even with the door open.



## WARNING

Risk of burns. Always open the door with caution when the oven is hot.



### HACCP

(Hazard Analysis and Critical Control Points): according to the system required, cooking data can be recorded on USB pendrive.



### Boiler Drain (only in boiler models)

Press this button to drain manually water from the boiler.

## F - Programs and Multiphase



### Programs

This button allows to save and recall up to 99 programs (recipes).



### Multiphase

Cooking with phases in sequence: this function allows to set cooking programs with up to 4 phases in automatic sequence.

## G - Indicator Lights



### Attention

It indicates a malfunction of the oven (warning / error).



### USB

It lights up when a USB device is connected to the oven.



### Wi-Fi

It indicates the successful connection to a Wi-Fi network (with appropriate accessory only).

## H - Digit Displays area



The **Humidity Digital Display** shows:

- the set humidity value in Combi Cycle or Convection Cycle.
- the humidification level from 10 to 100 in Boil-less models.



The **Temperature Digital Display** shows:

- The cavity set temperature
- The ECO DELTA cavity temperature.



The **Time/Food Probe Digital Display** shows:

- The cooking time.
- The food probe set temperature.

## I - Keypad

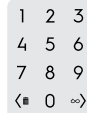

It allows to insert a numeric value in various functions.



**button**

- Press it to decrease the value on display (<);
- Keep the same button pressed to delete a phase or a program (☒).



**button**

- Press it to increase the value on display (>)
- Press the same button to select Continuous cooking (∞) while setting the Time.

## J – Cleaning cycle



### Cleaning Cycle

This function allows to clean the oven cavity automatically by means of dedicated cleaning cycles.

## F.3 Oven connectivity

If the oven is connected remotely to Cloud, the below indicator light illuminates or flashes according to the connection status.



### Indicator light status



Indicator light on: the oven is connected to Cloud.  
 Full brightness: the Wi-fi signal is **good**.  
 Half brightness: the Wi-fi signal is **medium or low**.



Indicator light flashing:

For 1 minute: the oven is establishing a connection to Cloud  
 Continuously: the oven is unable to connect to Cloud or there is no Wi-fi connection.

## F.4 Cooking cycle setting

### F.4.1 Select the required COOKING CYCLE

Press the relevant button to select a cooking cycle (for example the CONVECTION one).

- boiler model



- boilerless model



### F.4.2 Set the HUMIDITY

Press the humidity button. Set the value on the numeric keypad (for example 70%). The inserted value appears on the digit display.

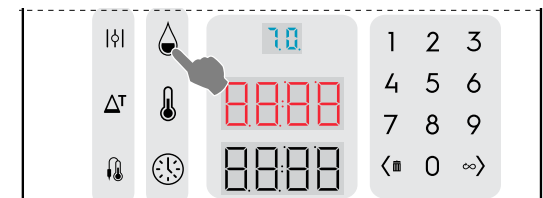

#### NOTE!

Regardless of the number entered, the values on the display will always be rounded to the nearest ten (10, 20, 30,... 90 and up to 99).

Entered values (%)	Output values (%)
From 1 to 14	10
From 15 to 24	20
From 25 to 34	30
From 35 to 44	40
From 45 to 54	50
From 55 to 64	60
From 65 to 74	70
From 75 to 84	80
From 85 to 94	90
From 95 to 100	99

### Humidity condition: WITH BOILER

- The Convection cycle allows to manage and adjust the amount of humidity in the cavity without generating any additional steam.
- Press the Humidity button and using the numeric keypad set the maximum humidity with consequent adjusting of the vent. By setting a value of 100, the valve closes ().

When the display shows the cavity does not manage the humidity as the valve is closed.

- When the Vent button is activated, the humidity is not adjustable. The vent is open and exhausts all the humidity from the cavity.

### Humidity condition: BOILERLESS

- The Convection cycle allows to manage the humidity level in the cavity.
- Press the Humidity button and using the numeric keypad set the humidity level.
- By setting a value of 0, the valve closes () and the cavity does not manage the humidity level.

- When the Vent button is activated, the humidity level is not adjustable. The vent is open and exhausts all the humidity from the cavity.

### F.4.3 Set the TEMPERATURE

Press the temperature button.

Set the value on the numeric keypad (for example 230°C). The inserted value appears on the digit display.

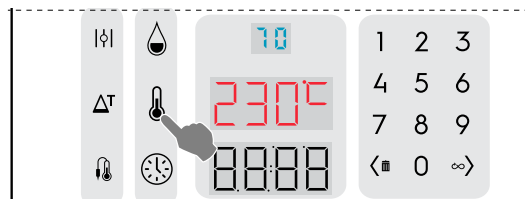

### F.4.4 Set the cooking TIME

- Press the time button.

Set the value on the numeric keypad (for example 45 minutes). The inserted value appears on the digit display.

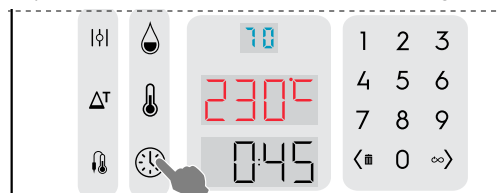

- Press the START button to start the cooking cycle. If you have set the Autostart the cycle starts automatically when closing the door.

### F.4.5 Preheating/Cooling phase

- This preparation phase prepares the cavity temperature before the beginning of the selected cycle. The Temperature Display shows the set temperature; the Time Display shows the message "PrEH" or "COOL" according to the cavity temperature; the Start button lights up red.

#### Opening the door after the START button is pressed:

- If the door is opened, the Preheating is interrupted (the Cooling phase keeps running); the Time Display shows the message "door".
- Once the door is closed, the Preheating restarts.

#### Skip Preheating/Cooling

- Keep pressed the start button to start immediately the cooking cycle.

- When the Preheating/Cooling is finished, the message "LOAD" appears on the Time Display; the Start button flashes in red.
  - Open the door;
  - Insert the food in the appliance;
  - Close the door: the cooking cycle starts.

### F.4.6 Stop cycle

Keep pressed the START button to stop the cycle.

### F.4.7 End cycle

- When the set time has elapsed the cooking cycle will stop automatically and the appliance's alarm will beep. Open the door and unload the product. The audible alarm can be muted by performing any operation on the control panel or by opening the door.
  - To stop the cooking cycle manually press the cycle START button for a few seconds.
  - To repeat the last cooking cycle with identical parameters press the START button again.

## F.4.8 FUNCTIONS & OPTIONS

### F.4.8.1 VENT VALVE OPEN

	Humidity option: for Convection cycle only.
---	---

Vent valve OPEN for very dry cooking allowing the removal of humidity when necessary.

Max. temperature up to 300°C)

### F.4.8.2 ECO DELTA

	Temperature options (for all cooking modes)
---	---

This function enables cooking without harming the food with high temperatures; this ensures more gentle and more even cooking, with less weight loss.

This is an advanced cooking method, where the oven compartment temperature varies according to the core temperature of the food.

1. Press the ECO-DELTA button  $\Delta^T$  to select this function.
2. Press this button again to digit the required value on the keypad, for example 30°C.  
It is possible to enter a value of delta temperature from 1 to 120°C.
3. Press the PROBE button . Set the required food core temperature.
4. Insert the probe into the food (see the paragraph F.4.8.5 FOOD PROBE).

This function is particularly suitable for cooking large pieces of food (at least 5kg, e.g. whole turkey, leg of pork, etc.).

In this case, cooking is moderate and long, since the cavity temperature is automatically adjusted according to the temperature inside the food (CORE PROBE), maintaining a constant difference (ECO-DELTA) between them, from start to end of cooking.



#### IMPORTANT

The ECO-DELTA function is only possible with the core probe inserted.





#### NOTE!

With ECODELTA on, the mode "Cooking Time" switches automatically to the "Core Probe" mode, that detects the inside temperature of the food.

### F.4.8.3 COOLING DOWN

	Fast cavity cooling
---	---------------------



Useful for switching from one type of cooking to another at lower temperature; it enables fan rotation and automatic injection of water even with the door open. This option is not available if the cavity temperature is higher than 180°C)

1. Press the COOLING DOWN button .
2. Enter the temperature value that the oven has to reach for the next cooking.
3. Press the Start button  to reach the set temperature.

### F.4.8.4 CONTINUOUS COOKING

	Time option
---	-------------

The cooking time is endless.

1. Press the endless button .  
The time display shows "cont".
2. Press the START button  to start cooking the food.
3. When the food is cooked keep pressed the START button  to stop the CONTINUOUS COOKING cycle.

### F.4.8.5 FOOD PROBE

	Time option
---	-------------

Adjustable PROBE to measure the product core temperature. This function excludes the cooking time setting.

1. Press the PROBE button;  
Set the core probe temperature on the numeric keypad (eg 55); the Time display shows the value entered.



The core probe allows accurate control of the core temperature of the product being cooked. When the set value is reached, the oven stops automatically.



#### NOTE!

It is possible to set the probe temperature from 15 to 290°C for Combi and Convection cycles and from 15 to 120°C for Steam cycle.

2. Close the oven door and press the START button  to start the probe cycle.  
Wait until the Temperature display indicates the end of the preheating phase. The message LOAD appears.
3. Open the door, insert the food into the cavity.



## WARNING

Risk of burns. Always open the door with caution when the oven is hot.

4. Remove the core probe from its seat;
5. Insert it in the product without forcing excessively;  
Make sure the tip - the sensitive part - is positioned near the centre of the product.

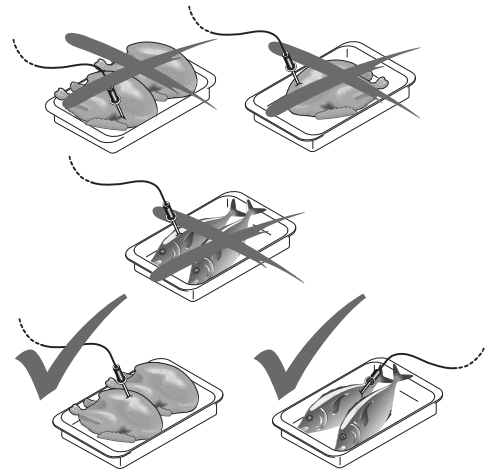

#### IMPORTANT

The core probe is a precision component. Absolutely avoid impacts, forcing when inserting, and pulling of the flexible cable (in particular when using the trolley-mounted structures).  
The warranty does not cover the replacement of core probes damaged by improper use.

6. Close the oven door.  
The PROBE CYCLE keeps running.

#### End Probe cycle

- When the required product core temperature is reached the oven stops automatically. The Time display shows the duration of cooking cycle;

### Probe cycle deactivation

- To deactivate the PROBE cycle simply press the TIME button and set a cooking time. This action automatically cuts out the core probe and viceversa. When the oven is switched off the core probe option is also deactivated.



#### NOTE!

With vacuum packed food products it is necessary to use the special external core probe (accessory available on request), to be connected to the USB pendrive. For its use see the dedicated paragraph.

### F.4.8.6 USB FOOD PROBE (on demand)

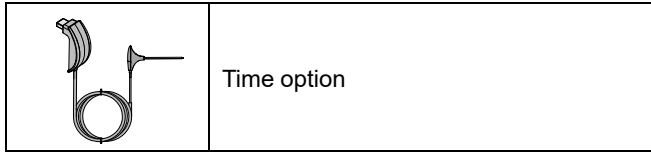

- Press the PROBE button and keep it pressed for almost 1 second.

The indicator light starts flashing (0,5 sec ON - 0,5 sec OFF).

Set the final core probe temperature on the numeric keypad (e.g. 55); the Time display shows the value entered.



#### NOTE!

It is possible to set the probe temperature from 15 to 290°C for Combi and Convection cycles and from 15 to 120°C for Steam cycle.

- Close the oven door and press the START button to start the probe cycle.  
Wait until the Temperature display indicates the end of the preheating phase. The message LOAD appears.
- Open the door, insert the food into the cavity.



### WARNING

Risk of burns. Always open the door with caution when the oven is hot.

- Insert the needle of the USB probe in the centre of the product without forcing excessively;
- Insert the USB end into the USB socket of the oven.

The indicator light is on steady.

- Close the oven door. The indicator light flashes (0,5 sec ON - 0,5 sec OFF).



#### IMPORTANT

If the indicator light flashes rapidly (0,1 sec ON - 0,1 sec OFF), the bigger display shows the flashing text label "UPrb" and an acoustic alarm sounds, make sure the USB probe is connected. In the meantime cooking is on hold.

The PROBE CYCLE keeps running.

When the set value is reached, the oven stops automatically.

### F.4.8.7 MULTIPHASE

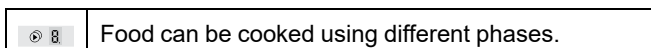

The oven allows to set up to 4 phases for each cycle.

During a multiphase cooking cycle the oven switches automatically from one phase to the next one. The cycle stops when all phases are completed.

#### To set a multiphase cycle:

- Set first a cooking cycle (refer to F.4 *Cooking cycle setting* chapter);
- Keep pressed the multiphase button to add phase 2;
- Set phase 2
  - It is possible, at this stage, to set the parameters of the new phase.
  - Repeat the sequence for all phases to be set.
- At the end press START button to start the cooking cycle.

#### To delete a phase:

- Select the phase to be deleted using the arrows < / > on the keypad
- Keep pressed the waste bin icon.



#### NOTE!

By deleting an intermediate phase, the following phases will also be automatically cancelled.

### F.4.8.8 UTILITIES

Utilities are functions that can be added to the cooking cycle. They are activated simply by pressing the relative button.

#### Pause

- Add a new phase;
- Press the Pause button ;
- Set the desired duration using the TIME button.



#### NOTE!

This utility can be used as delay start if set at the beginning of a multiphase cycle.

#### Hold

- Pressing the Hold button will add the holding phase at the end of the cooking cycle.  
During the holding phase the letter H appears in the Multiphase display while the Time display shows HOLD.
- If cooking is time driven, the holding temperature is + 65 °C. If cooking is probe driven the holding temperature is 5 °C more than the set core temperature.

#### Boiler Drain

- The boiler can not be drained during a cycle.

#### Cool Down

- The cool down can not be activated during a cycle.
- The default temperature is 25 °C, but can be changed by setting it on the keypad.
- To see the actual temperature of the cell, keep the Temperature button pressed for more than 2 seconds.

## F.5 Programs

The Programs button allows to recall cooking cycles already stored or create and store new ones.

To exit from the Programs keep pressed one of the cooking modes.

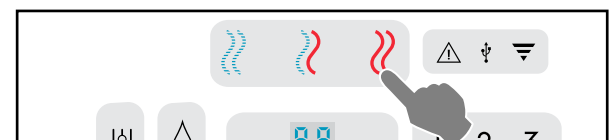

#### Program saving

- Set first a cooking cycle (refer to F.4 *Cooking cycle setting* paragraph);

- Keep pressed the Programs button. The display shows the first program number available;

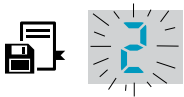

- Select the desired Program number (01– 99) using the arrows < / >;
- The Programs Display will continue to flash for a few seconds; to complete the procedure keep pressed again the same button for a few second until beep confirms the program saving;
- Press now the Start button to start the program.



**NOTE!**

In models with boiler two preset programs for Regeneration are already saved and available in Program number “1” and “2”.

**Regeneration programs:**

1. **Regeneration on Plate** - ideal for banqueting  
Double phase:
  - Convection cycle of 2 minutes, 120 °C, flap closed and ventilation at 4;
  - Combi cycle of 5 minutes, 120 °C, 20% humidity and ventilation at 4.
2. **Regeneration on tray** – ideal for rethermalizing  
Combi cycle of 15 minutes, 120 °C, 40% humidity and ventilation at 5.

**Program deleting**

- Select the program to be deleted;
- Keep pressed the (delete) button for a few seconds and press the same button again to confirm deleting procedure.

**Uploading / downloading Programs – USB**

This procedure is only possible from the **starting oven status**.



**NOTE!**

To reach the oven starting status keep pressed one of the available cooking modes as shown in the figure.



1. Insert the USB pendrive into the socket.
2. To upload / download Programs, keep pressed the Programs button until the PrOG appears on the Temperature display.
3. Use the arrows buttons < / > on the keypad to select “upload” or “download” command.

The word “dnLo” or “UPLO” appears on the Time display according your selection.

4. Keep pressed the Programs button to start the uploading or downloading procedure.  
All the control panel indicators light flash.
5. At the end, on the Time Display the flashing word End appears to confirm the completed operation.
6. Remove the USB pendrive from the socket.

**Programs from Cloud**

The oven is able to connect to Internet and receive cooking programs (recipes) from cloud.

When the cloud has sent one or more programs to the appliance, the message “CLOU PrOG shows up in Temperature and Time displays.

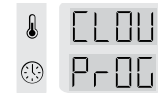

The number of programs downloaded is shown in Program display.



- Press any key to add the new programs to the appliance. The message CLOU PrOG disappears.

**Downloading HACCP log**

This procedure is only possible from the starting oven status.

1. Insert the USB pendrive into the socket.
2. To download the HACCP log, keep pressed the HACCP button until the word HACP appears on the Temperature display.  
The word “dnLo” appears on the Time display.
3. All the control panel indicators light flash.
4. At the end, on the Time Display the flashing word End appears to confirm the completed operation.
5. Remove the USB pendrive from the socket.

**F.6 Indicator Lights**



**NOTE!**

The indicator lights are not buttons, but only function or warning lights.

**ALARM**



The light flashes to indicate the presence of a malfunction. It can be a warning or an error.

**USB**



This light indicates the insertion of an USB device. At the beginning it flashes, then when the USB has been recognized it becomes fixed.

**Wi-Fi**



This light indicates the connection to a Wi-Fi network (with appropriate accessory only).

**F.7 Special functions**

The special functions allow to improve the use of the oven and can be used with more or less intensity.

## WATER INJECTION



During a cooking cycle it is possible to increase the humidity in the cavity for certain types of cooking.

Press repeatedly this buttons to adjust the injection duration in seconds (every dash = 10 s intervals).

In the figure above (for example) 3 dashes corresponding to 30 seconds of water injection are indicated.



## WARNING

Open the door carefully, water is sprayed onto the fan.

## FAN



This function allows you to adjust the fan speed for some types of cooking such as the most delicate ones.

Press repeatedly the button above to adjust the 5 speed levels. In the figure above (for example) 4 dashes corresponding to a high speed are indicated.

## F.8 HOOD MANAGEMENT

Once the hood is installed on the oven and enabled, the oven displays will show some text label to remind that the hood maintenance is required after a period of working time.



### Label text meaning

CLLP	Clean hood's lamp
rEPL	Replace hood's lamps
CLCS	Clean hood's condensation sink
CLFt	Clean hood's demister and water separator filter

This reminder can be skipped or, if the maintenance has been done by the Service, confirmed.

### To skip the reminder:

- Simple press START button.



The reminders appear only after 7 days of continuous operation.

## F.9 Cleaning cycles

### F.9.1 Set a cleaning cycle

The oven is equipped for cleaning the cavity automatically.



#### IMPORTANT

To prevent material damage, injury or fatal accidents remove any object (trays, accessories,...), trolley excluded, from the oven cavity before the washing cycle.

- Press the button to enter the cleaning mode.

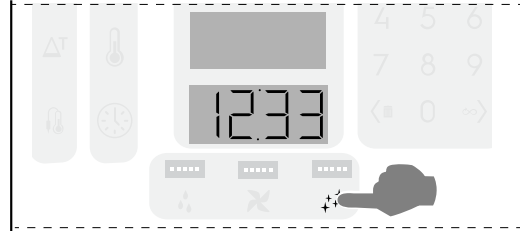

- Press repeatedly the button to set one of the 5 available cleaning cycles.

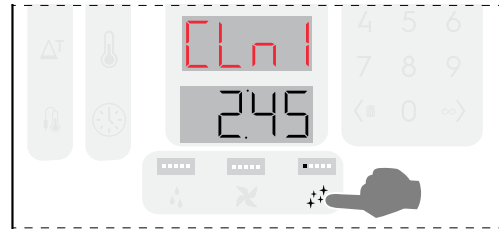

### F.9.2 Available cleaning cycles

CLn1	<b>Short</b> = Soft washing cycle Cleaning for low dirt level, i. e. steaming, baking or single loads with cooking temperatures lower than 200°C
CLn2	<b>Medium</b> = Medium washing cycle Cleaning for medium dirt, i. e. roasting or baking with cooking temperatures lower than 200°C
CLn3	<b>Intensive</b> = Strong washing cycle Cleaning for medium-high dirt level with roasted and grilling deposits
CLn4	<b>Rinse</b> = Rinse cycle Rinsing with cold water
dESC	<b>Descaling</b> = Descaling cycle Maintenance cycle to remove lime build up in the boiler.

### F.9.3 Start the cycle

- Press the button to start the cycle;



#### IMPORTANT

If the cavity temperature is too high, the START button is disabled. Press the button to cool down the oven.

**Put the cleaning detergent only after the cool down is completed as high temperature might trigger a chemical reaction!**

- Before starting the selected cleaning cycle, the displays shows a message to remind you to empty the cavity. Open the door and **REMOVE ANY OBJECT from the cavity** (pans, trays, accessories or others !!).

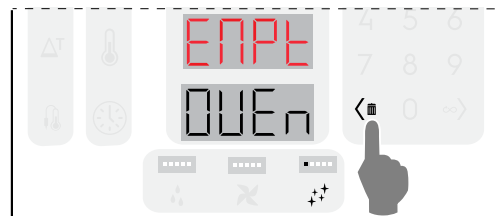

Press button on the keypad to confirm.

- The displays then show a message to remind you to add the detergent agents. Put the cleaning detergent into the filter of the cavity and the rinse & descale tablet into the dedicated drawer (its position changes according to the model).

Quantities vary according to the selected cycle (refer to the tables in this chapter or to the sticker on the oven).

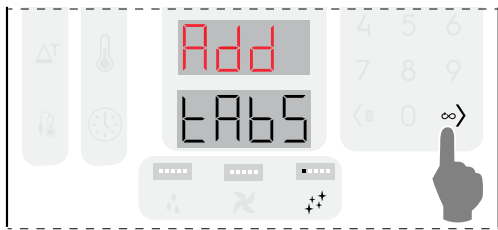

Press  $\infty$  button to confirm the solid chemical loading.

If the cavity temperature is higher than 40 °C [104 °F] the oven will force the cool down prior to any cleaning cycle. **Put the cleaning detergent only after the cool down is completed as high temperature might trigger a chemical reaction!**

- Close the door; The oven performs a short procedure to set up the cleaning and checks if any object is still present in the cavity for safety reasons. The lower display shows a small animation

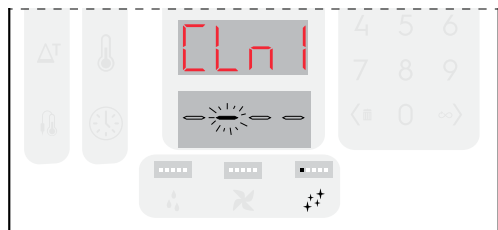

- If you intend to **cancel the cleaning cycle** during this phase, press START PAUSE button. The displays show a message that will warn you to remove any chemical from the cavity and/or from the drawer.

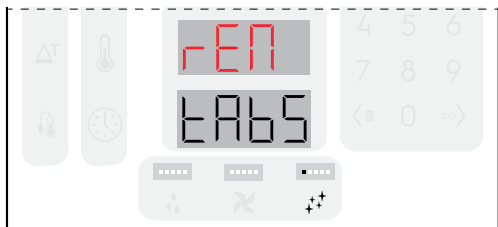

**IMPORTANT**

To remove the tablets, use gloves and just lift the filter from the centre of the cooking chamber. Afterwards, we highly recommend running a rinse cycle.

At the end of the cleaning setting up, the cleaning cycle starts.

- If an object is detected in the cavity** the displays show the text "EMPt ovEn" and an acoustic alarm sounds. Open the

door, remove the object and press  $\infty$  button. The cleaning setting up starts again. Then, the cleaning cycle starts.

**F.9.4 Cleaning cycle information on displays**

The various displays will show the following text:

While setting cycle:

- Temperature display = selected cycle (for example CLn1)
- Time display = estimated cycle duration.



After cycle is started:

- Temperature display = selected cycle
- Time display = remaining time.



At the end of the cycle:

- Temperature display = selected cycle
- Time display = Message "End".

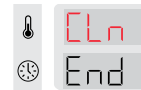

Press any key to exit from cleaning mode.

**F.9.5 Detergents**

To ensure best cleaning results, as well as to protect the oven with the cleaning programs, use the detergents, rinse aid and descale agents approved by which already comply with fluid category 3, as per current regulations and legislation.



**IMPORTANT**

Use only original or recommended cleaning and maintenance products. Cleaning agents being not original or not recommended by can seriously damage the appliance. Damages caused by using different cleaning and care products than those recommended by the manufacturer are excluded from the warranty. Wrong cleaning chemicals could leave behind chemical residues in the cooking chamber and/or create strong chemical reactions with severe consequences inside the cavity, which in worse cases may turn into explosion.

**Standard configuration**

**SOLID detergent**

Open and empty the number of sachets indicated in the following tables into the drain filter in the centre bottom of the cavity;

**A**



**IMPORTANT**

approved cleaner: Cleaning Tab C22 (where available) or C23 Cleaning Powder.

**RINSE AID**

**Standard configuration**

**SOLID rinse & descale in tablets**

Open and empty the number of tablets indicated in the following tables into the dedicated drawer (see following figures).

**B**

Descal effect available only in models with boiler.



**IMPORTANT**

Use only C25 Rinse and Descal tabs

### F.9.6 Detergent loading

#### SOLID CHEMICAL LOADING OF 6 - 10 GRIDS MODELS

6 – 10 GN model		
Cleaning Cycle	A	B
	Detergent	Rinse aid / Descaling
	Quantity (N. Tab/Sachet)	
CLn1	2	0
CLn2	2	1
CLn3	3	1
CLn4	0	0
dESC	0	2

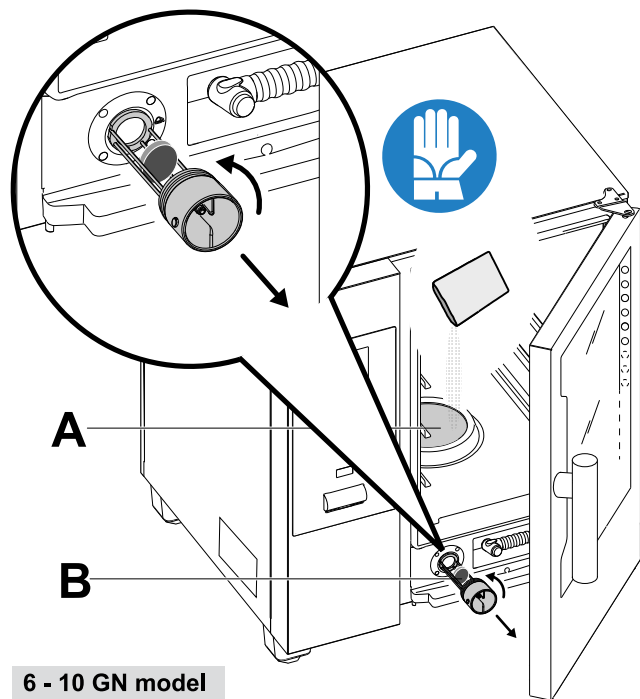

6 - 10 GN model

#### SOLID CHEMICAL LOADING for 20 GRIDS MODELS

20 GN model		
Cleaning Cycle	A	B
	Detergent	Rinse aid / Descaling
	Quantity (N. Tab/Sachet)	
CLn1	2	0
CLn2	2	2
CLn3	3	2
CLn4	0	0
dESC	0	3

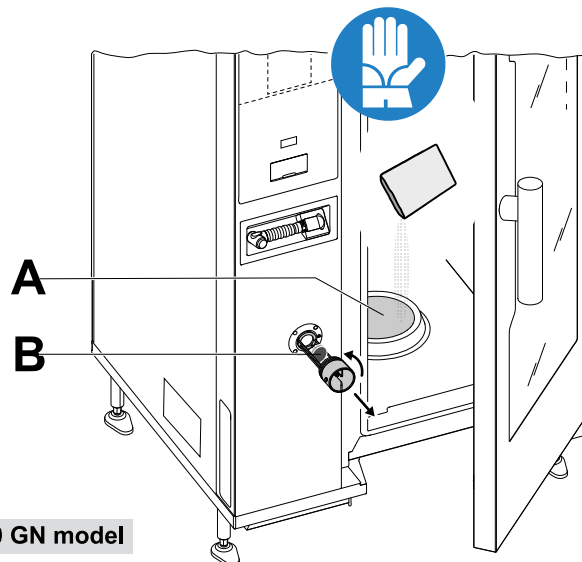

20 GN model

### F.9.7 Precautions



#### IMPORTANT

In 20 Grids models run the cleaning cycles only with trolley inside the oven. It helps the sealing in closing the bottom openings between the cavity and the door.



#### WARNING

To prevent material damage, injury or fatal accidents do not clean or leave accessories/trays (trolleys excluded) inside the unit. Empty the cavity before proceeding.



#### IMPORTANT

Do not use detergent or rinse aid powder dissolved in water or in gel form and/or containing chlorine.



#### WARNING

Both chemical substances and hot steam can escape from cavity with risk of burns and scalding. Use Gloves.

Always refer to the safety cards and labels on the products used.



#### WARNING

Do not start any cooking cycle if the cleaning cycle has not been completed and/or after cleaning cycle completion if there are still detergent residuals, if any.



#### WARNING

Do not open the cooking cavity door while cleaning cycle is operating.



## WARNING

In case of steam leakages from the cavity door and/or visible wearing or damage of cavity door gasket, do not start any cleaning cycle.

Call the Customer Care Service.

### F.9.8 FORCED CLEANING

This function measures the oven cooking time elapsed from the last automatic cleaning cycle. If the limit is reached (the default value is 24h), no further cooking cycle is allowed.

- The Time display shows the flashing message FCLn. It is necessary to perform one of the automatic cleaning cycles.



- At the conclusion of the selected cleaning cycle, the FCLn alert disappears; the cooking functionality is now restored.



#### NOTE!

This function can be activated at the customer's request during installation of the oven or afterwards. If necessary, contact the authorized Customer Care service.

### F.9.9 Boiler descaling (dESC cycle)

During the routine washing cycle with solid chemicals (rinse & descale blue tablets) the boiler is maintained scale free. However, it is recommended to run the dedicated "dESC" cycle regularly, based on how frequently the appliance is used.

To select this cycle:

- Press repeatedly the button  to set the dESC cycle. Use the quantities of "C25" tabs specified for 6–10 GN models and for 20 GN models, as indicated in this chapter or on the sticker on the oven.



- If, after carrying out this descaling cycle, the display shows the error code "dESC" again, call Service.



#### NOTE!

In the boiler descaling cycle as well as in the rinsing cycle, there is no cleaning setting up phase.

### F.10 SWITCH THE OVEN OFF

Press the "O" side of the button "O – I" to switch the oven off.

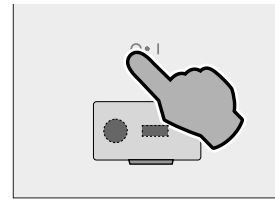

#### IMPORTANT

Before switching off, the appliance executes a cavity drying: the cooling fan remains active at the maximum speed to cool down the components compartment and to dry the oven chamber. The red and white displays show a flashing message: "OPEN DOOR".

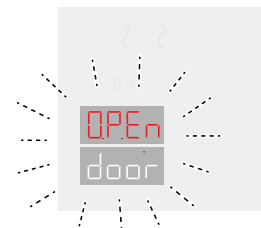

If equipped, the oven will empty the boiler. The next time the oven is switched on and a cooking mode that uses the boiler is selected, the boiler will be refilled.

- If the oven door is opened, the drying procedure starts with a 5-minutes countdown. Then, the oven switches off.

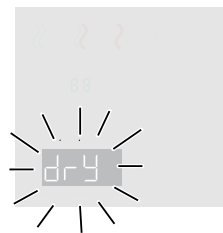

- If the door is still closed, the displays flash for about 30 minutes, then the oven switches off.



#### NOTE!

Drying is NOT carried out if the oven was cooking or washing when it was switched off.

## G APPLIANCE CLEANING



## WARNING

Refer to "WARNING and Safety Information".

### G.1 Care information

Care operations have to be carried out by the owner and/or user of the appliance.



#### IMPORTANT

Problems resulting from poor or lack of care as hereinafter described will not be covered by the warranty.

### G.2 Cleaning introduction



## WARNING

Use heatproof gloves when operating with hot parts.

To help reduce environmental impact, we recommend using cleaning products designed with sustainability and biodegradability in mind.

Use detergents as mentioned below if necessary, and a Microfibre<sup>1</sup> cloth for cleaning stainless steel surfaces or Brush<sup>2</sup>. If another type of detergent is used, carefully follow the producer's instructions and observe the safety rules given in the information sheets provided with the product or substance.

1. You can order it with this reference code 0S1779.  
2. You can order it with this reference code 095782.

Rinse and dry thoroughly.



#### CAUTION

- Do not use solvent-based detergents (e. g. trichloro-ethylene) or abrasive powders for cleaning.
- Do not use chemical products such as sodium hypo chlorite (bleaching powder), hydrochloric acid (muriatic acid) or other acids to clean the surfaces of the appliance.  
Do not use the above products even for cleaning zones next to the appliance, their vapours can damage it.
- Do not use steel brushes, steel wool, copper cloths, sand-based or similar products for cleaning.

### G.3 Appliance cleaning

Your oven is subject to soiling every time it is used for cooking: the type of soiling and its location in the oven depend on many factors. Hereafter, you will find information about the location of the parts to be cleaned and how often they should be cleaned.

### G.4 Cooking chamber (cavity)

It is suggested to clean it at least once a day in case of daily use: it could happen, with particular types of cooking, to have to clean it even more than once a day.

- To clean the cooking chamber, press the Cleaning button  to select the dedicated program (refer to F.9.2 Available cleaning cycles table).

### G.5 Boiler or steam generator (models equipped only)

A descaling phase is included in the same washing programs as the cooking chamber, with the exception of the rinsing program. Make sure to add the specific tabs as explained in F.9.6 Detergent loading paragraph.

It is recommended to run the dedicated cleaning cycle "dESC" regularly, based on how frequently the appliance is used.

### G.6 Cooking chamber filter

Once a week:

This filter is clearly visible in the centre of the bottom of the cooking chamber and is used to prevent damage to the washing pump and/or to avoid obstructions in the washing circuit.

1. Lift the filter to remove it from its housing;

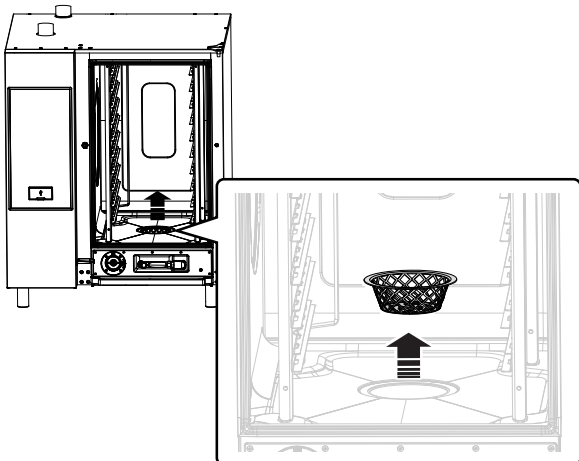

2. Wash the filter in the dishwasher with a gentle programme; in other cases, wash the filter by hand with neutral dish washing detergent and rinse thoroughly;
3. Refit the filter in its place.

### G.7 Air filter

It is a polyurethane sponge, housed in a support equipped with slits for the inlet of the cooling air of the oven components (see figure for "table-top" models for example).

It avoids that the impurities of the kitchen environment (oils, greases, flours, powders,...) are transported on the internal components causing malfunctions.

Once a month:

1. Unlock the filter support by unscrewing the screws and remove it;

The pictures refer to 6-10 GN model

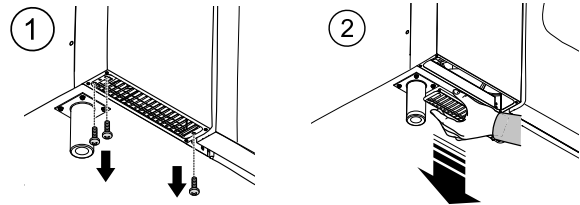

2. Remove the filter and degrease it by washing it with dish detergent;
3. Dry the filter and put it back in the support;
4. Put the support back in place. If necessary, depending on your model, secure it with the screws.

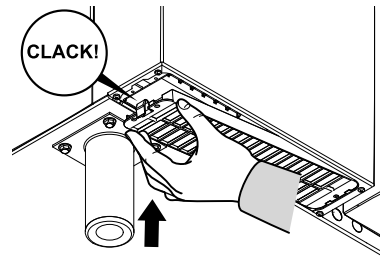

#### NOTE!

It is mandatory to install it again for safety requirements. If the filter is not present the appliance will stop working.

### G.8 Door gasket

The silicone gasket that surrounds the oven door is an essential element in achieving the desired cooking results and preventing air, water or steam leakage during oven operation. The gasket is the most stressed element of the oven because it is subject to multiple types of stress: thermal, chemical, physical.

Carefully clean the oven door and the gasket using a micro-fiber cloth soaked in warm water with a neutral detergent at least once a day (before or after cleaning). The daily care will considerably prolong the gasket's life. Never use abrasive products to clean the gasket.



#### IMPORTANT

In case of cooking at temperatures above 260 °C, repeat the gasket's cleaning operations a few more times during the day. Do not leave the oven running at high temperatures without a load.

Replace the oven door gasket every six (6) months.

To replace it, proceed as follows:

1. Remove the gasket from its seat;
2. Clean the seat of any traces of dirt;

3. Insert the new gasket along the entire seat.

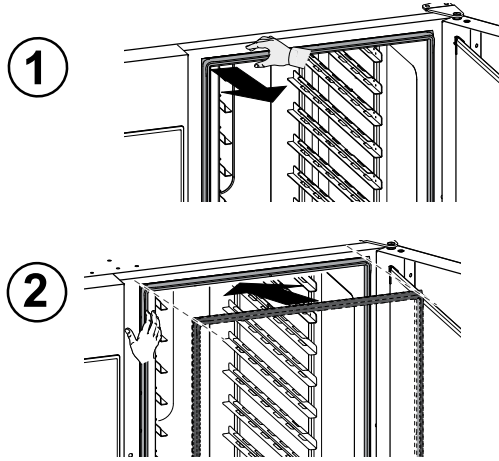

2. With the door open, press the two retaining clips (top and bottom) as shown in the figure to reach the intermediate space between the inner glasses and external glass; Clean both sides of the internal glass doors using a glass product;

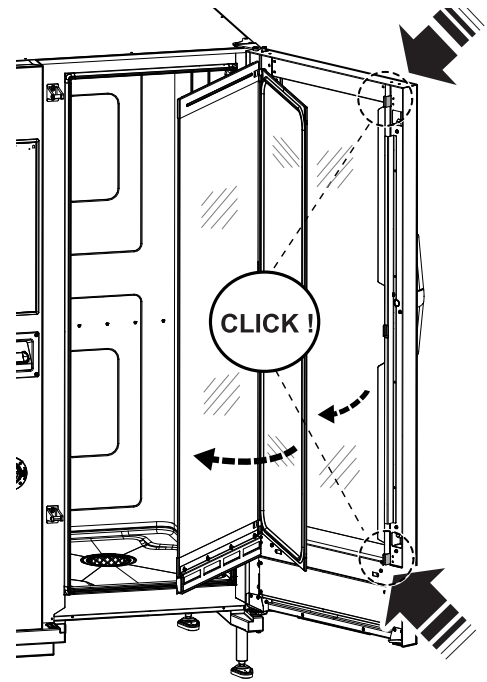

### G.9 Inner glass doors and cooking chamber glass

Keeping the glasses mounted on the oven door clean is important for their dual role: shielding the user from the temperatures that develop in the cooking cavity and allowing visibility inside to ensure control of the cooking at all times.

**After each washing cycle** of the cooking chamber:

1. Clean the edge of the internal glass. See figure below (20GN model);

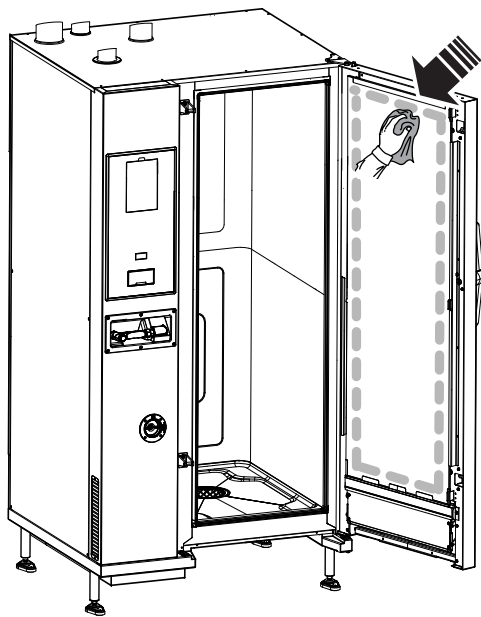

3. Then, clean all the reachable surfaces between the doors.
4. Refit the internal glass into the clips and close the oven door.

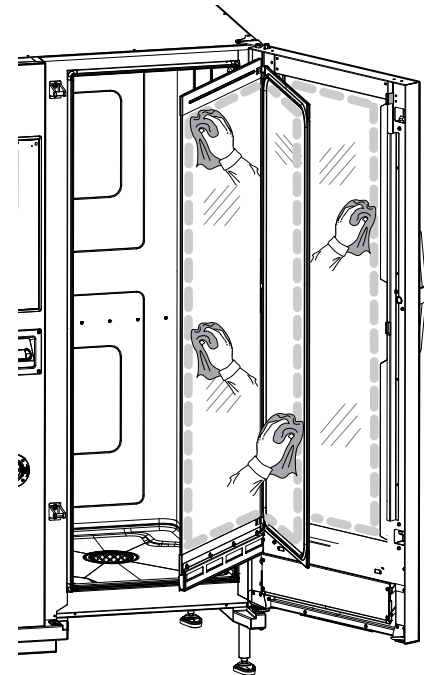

### G.10 Door area



#### IMPORTANT

It is strongly recommended to clean **each day** the area along the entire door perimeter, the rubber gasket and the internal glass especially near the edge.

After cooking cycle the oven door, its internal glass, the gasket and the area around the door perimeter may become easily dirty due to greasy vapours coming out from the oven. These operations must be done with the door glass cold, without using abrasive detergents or rags.

1. Clean thoroughly the oven area along the door perimeter as indicated in the following figure:

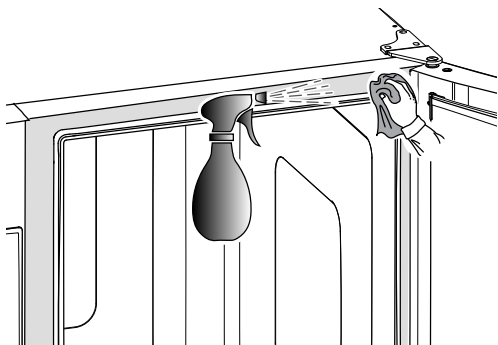

2. Clean along the rubber gasket;

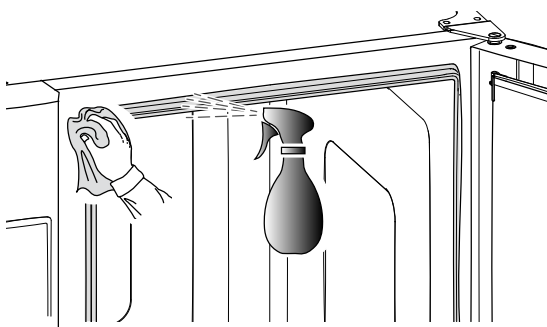

### G.11 Efficiency control of the discharge system

Residues released during cooking, despite regular cleaning of the cooking chamber, can encrust the external discharge pipe. It is therefore essential to check the efficiency of the discharge and to clean the external pipe as soon as there are signs of obstruction. At least **once a year**, clean the drain pipe.

### G.12 Condensate drip collector

The plastic drip collector under the cooking chamber ensures that the steams that condense as soon as the door is opened are collected and discharged.

For hygiene reasons, clean it as follows:

1. Use water to clean regularly the drain pipe ("A") of the drip collector;  
If the discharge is not uniform spray a neutral detergent solution and let it melt the incrustations before cleaning with water jet.
2. Remove the metal cover ("B") and use the same system to clean the single check valve ("C");

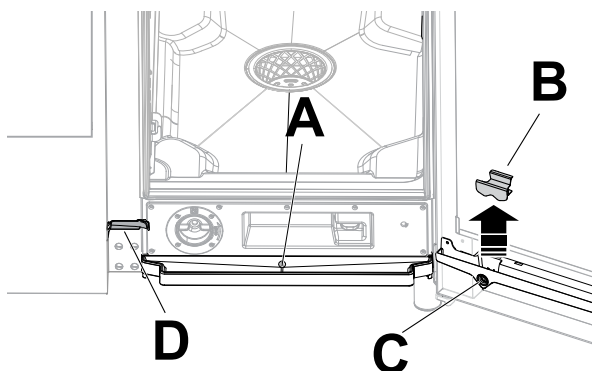

3. Use regularly a pipe cleaner with nylon bristles (supplied with the appliance, according to the model) to clean the small gutter ("D").

### G.13 Food probe

Residues released during cooking, despite regular cleaning of the cooking chamber, can encrust the food probe, altering the temperature detection.

To ensure optimal operation of the oven with the food probe, it is recommended to clean the food probe manually **every day**, using lukewarm water and neutral soap, avoiding tying the cable of the probe and rinsing with water.



#### IMPORTANT

Pay particular attention when handling the probe; remember that it is a sharp object, therefore handle it very carefully, even during cleaning.

### G.14 Other surfaces

- Clean external glass, metal and plastic parts only with non-aggressive detergents. Stop immediately using those products if detecting any visual or tactile characteristic change on surfaces and thoroughly rinse with water (examples: glass becoming mat/scratched/other, or plastic discoloring/melting/other, or metal showing rust/stains/scratches). Carefully dry after rinsing.



#### IMPORTANT

As for the plastic handle, do not use detergents containing sodium hypochlorite.

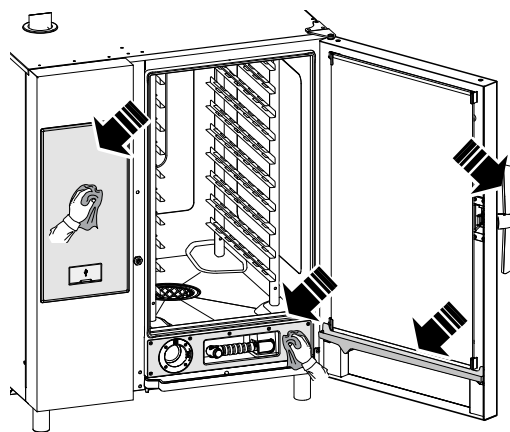

- Clean the stainless steel parts every day using lukewarm neutral soapy water;  
Rinse with plenty of water and dry thoroughly.
- Do not clean the stainless steel with steel wool, brushes or scrapers in common steel, as they could deposit ferrous particles which oxidize, causing rust spots;

### G.15 Periods of non-use

If the appliance is not going to be used for some time, take the following precautions:

- close the water supply tap(s), if present;
- close the gas valves;
- disconnect the power supply or remove the plug from the power socket, if present;
- clean the cabinet, going over all the stainless steel surfaces vigorously with a rag moistened with paraffin oil to create a protective film;
- periodically air the premises.



#### IMPORTANT

The warranty does not cover any damages caused by ice formations in the appliance pipes.

### G.16 Replacing wear and tear components

There are parts, whose damage happens because of the ordinary use during a period, which are not covered by the manufacturer warranty.

## G.17 Repair and extraordinary maintenance



### NOTE!

Repair and extraordinary maintenance have to be carried out by specialised authorised personnel, who can ask the manufacturer to supply a servicing manual.

## G.18 Maintenance intervals

It is advisable to carry out the checks with the frequency given in the following table:

Maintenance, inspections, checks and cleaning	Frequency	Responsibility
Ordinary cleaning <ul style="list-style-type: none"><li>• general cleaning of appliance and surrounding area</li></ul>	• Daily	• Operator
Mechanical protection devices <ul style="list-style-type: none"><li>• check their condition and for any deformation, loosening or removed parts</li></ul>	• Every 6 months	• Service
Control <ul style="list-style-type: none"><li>• check the mechanical parts, for cracks or deformations, tightening of screws: check the readability and condition of words, stickers and symbols and restore if necessary</li></ul>	• Yearly	• Service
Appliance structure <ul style="list-style-type: none"><li>• tightening of main bolts (screws, fixing systems, etc.) of appliance</li></ul>	• Yearly	• Service
Safety signs <ul style="list-style-type: none"><li>• check the readability and condition of safety signs</li></ul>	• Yearly	• Service
Electrical control panel <ul style="list-style-type: none"><li>• check the electrical components installed inside the electrical control panel. Check the wiring between the electrical panel and appliance parts</li></ul>	• Yearly	• Service
Electrical connection cable <ul style="list-style-type: none"><li>• check the connection cable (replace if necessary)</li></ul>	• Yearly	• Service
General appliance overhaul <ul style="list-style-type: none"><li>• check all components, electrical equipment, corrosion, pipes...</li></ul>	Every 10 years <sup>1</sup>	• Service

1. The appliance is designed and built for a duration of about 10 years. After this period of time (from commissioning) the appliance must undergo a general inspection and overhaul.

## G.19 Maintenance contacts (only for Australia)

For service and spare parts, please contact:

## H TROUBLESHOOTING

### H.1 Introduction

Certain faults may occur during normal use of the appliance. In some cases, faults can be eliminated easily and quickly by following the indication below.

The display, if present, always shows a warning message or alarm describing the occurring fault.

**If the fault persists, contact the Customer Care Service:**

1. Disconnect the appliance from the main power supply;
2. Switch off the safety circuit breaker ahead of the appliance;

### H.2 Error codes

Check the anomaly indicated by the warning alarm and, if required, contact the Customer Care Service.

3. Close the gas and water tap(s), if they are present;
4. Remember to specify:
  - the type of fault
  - the appliance PNC (product number code)
  - the Ser. No. (appliance serial number).



### IMPORTANT

The appliance PNC and serial number are essential for identifying the type of appliance and date of manufacture.

Anomaly	Type of anomaly	Description	Possible causes	Actions
ACUP	Stop appliance	After software update error appears	Communication protocol between UI and ACU is not working	Call service
CHEM	Warning	The oven detects a water missing situation when EV11 is open.		The water flow is low. It could just be necessary to check if all the chemicals have been dissolved in the dedicated wash drawer.
CLLP	Reminder	Only Lev. 4 hood		Clean hood's lamp
CLCS	Reminder	Lev. 3 and 4 hoods		Clean hood's condensation sink
CLFt	Reminder	Lev. 3 and 4 hoods		Clean hood's demister and water separator filter
CLdr	Warning	Cleaning drawer cap missing before starting a cooking or cleaning cycle	<ul style="list-style-type: none"> <li>The cap of the cleaning drawer is not detected. It is not possible to START a cooking or cleaning cycle.</li> </ul>	<ul style="list-style-type: none"> <li>Screw correctly the cap on the cleaning drawer in the front of the oven;</li> <li>If the error persists, rotate the cap 180° and screw again. Call Service.</li> </ul>
FCt	Stop appliance.		The User Interface is not programmed with the software.	
Hd04	Stops appliance	Shower valve BV4 not working		Switch the oven OFF/ON. If the error persists, call Service.
PdEF	Stops oven	Memorized default parameters corrupted	Physical memory failure	Parameters memory corrupted; <ul style="list-style-type: none"> <li>Try to switch the oven OFF/ON.</li> <li>If the problem persists, call service.</li> </ul>
rEPL	Reminder	Only Lev. 4 hood		Replace hood's lamps
S111	Stop appliance		This alarm occurs when a software misalignment is detected	Call service
S126	Stop appliance		This alarm occurs when a software misalignment is detected	Call service
N°1 Ertc	Warning	Problem with internal clock	Issue with hardware (for example battery clock exhausted).	It is possible that some functionality do not work (for example HCCP). <ul style="list-style-type: none"> <li>Call Service.</li> </ul>
N°101 butn	Stops oven	One or a combination of the panel buttons are permanently blocked	The panel has been accidentally hit or damaged.	Press all buttons to possibly unlock the wrong one/ones. The permanent blocked buttons are lighted during the error on display.
N°103 FLA2	Stops oven; fatal error	Communication channel between FRAM and microcontroller is malfunctioning or blocked	Unknown SPI-FLASH memory device.	<ul style="list-style-type: none"> <li>Switch OFF and ON the oven, if the problem persists, call Service.</li> </ul>
N°104 FrA1	Stops oven; fatal error	The FRAM ID is different as expected	Communication impossible with FRAM memory.	<ul style="list-style-type: none"> <li>Switch OFF and ON the oven, if the problem persists, call Service.</li> </ul>
N°105 FrA2	Stop oven; fatal error	The FRAM power fail data calculated MD5 is different as the stored one	Unknown FRAM memory device.	<ul style="list-style-type: none"> <li>Switch OFF and ON the oven, if the problem persists, call Service.</li> </ul>
N°106 FrMC	Stops oven; fatal error	The FRAM power fail data calculated MD5 is different as the stored one	Software error: invalid data on FRAM memory.	<ul style="list-style-type: none"> <li>Switch OFF and ON the oven, if the problem persists, call Service.</li> </ul>
N°107 SCbL	Stops cleaning	Appliance is ON but ON/OFF switch feedback still OFF	<ul style="list-style-type: none"> <li>Wiring</li> <li>Connection loose.</li> </ul>	The appliance is ON but the ON/OFF switch shows still OFF. Cooking still possible. The cleaning is blocked for safety reason. <ul style="list-style-type: none"> <li>Try to switch the oven OFF/ON. If the alarm persists, it is still possible to operate cooking, but it is recommended not to start any cleaning cycle until the service will have resolved the issue.</li> <li>Clean manually the oven and call Service.</li> </ul>
N°110 bAtt	Warning	Battery is low	Ageing	Call Service to replace battery.

<b>Anomaly</b>	<b>Type of anomaly</b>	<b>Description</b>	<b>Possible causes</b>	<b>Actions</b>
N°111 rtc1	Warning HACCP will not function	The communication between the RTC and the microcontroller is blocked	Communication impossible with internal clock.	<ul style="list-style-type: none"> <li>• Call service</li> </ul>
N°112 Urt2	Stops oven	The RTC stopped flag is active even after the power on recovery procedure	Internal clock permanently locked.	Call service.
N°113 Urt3	Stops oven	The RTC internal oscillator is malfunctioning	Clock oscillator failure.	Call service.
N°115 ACUS	Blocks oven; fatal error	ACU software version (main uC) incompatible with present UI SW version	Wrong software upload (example: after replacing ACU board, the SW is not uploaded)	ACU software version (main uC) incompatible with present UI SW version. Call Service.
N°116 ACSS	Blocks oven; fatal error	ACS software version (inside ACU board) incompatible with present UI SW version	Wrong software upload (example: after replacing ACU board, the SW is not uploaded)	ACS software version (inside ACU board) incompatible with present UI SW version. Call service
N°117 tCMS	Stops oven; fatal error	TC software version (inside ACU board) incompatible with present UI SW version	Wrong software upload (example: after replacing ACU board)	TC software version (inside ACU board) incompatible with present UI SW version. <ul style="list-style-type: none"> <li>• Call service</li> </ul>
N°118 InuS	Stops oven	Inverter software version (YODA board) incompatible with present UI SW version	Wrong software upload (example: after replacing ACU board)	Inverter software version (YODA board) incompatible with present UI SW version. Call service
N°120 PUSr		The User parameters calculated is different to the stored one	Invalid data on User parameters	<ul style="list-style-type: none"> <li>• Call service</li> </ul>
N°121 PFAC	Stops oven	Factory parameters map corrupted	Issue with the SW or with the HW.	<ul style="list-style-type: none"> <li>• Try to switch the oven OFF/ON.</li> <li>• If the problem persists, call Service.</li> </ul>
N°122 PUOr		One or more User parameters are out of range	One or more User parameters are out of range	<ul style="list-style-type: none"> <li>• Call service</li> </ul>
N°123 PFOr		One or more Factory parameters are out of range	One or more Factory parameter are out of range	<ul style="list-style-type: none"> <li>• Call service</li> </ul>
N°125 PCE1	Stops oven	Wrong Parameter configuration: Appliance with boiler but without lambda probe		Wrong Parameter configuration: Appliance with boiler but without lambda probe.
N°130 EGA0	Stops oven	No one valid GAS table present in the oven	Software missing	No one valid GAS table present in the oven. Call Service.
N°131 EGAt	Stops oven	GAS table for this appliance model not found	Software missing	GAS table for this appliance model not found. Call Service.
N°132 EGAd	Stops oven	Wrong GAS table data	Software missing	Wrong GAS table data. Call Service.
N°135 ECLt	Stops oven	Cleaning table not present for the MODEL and the DETERGENT TYPE in use	Software missing	Cleaning table not present for the MODEL and the DETERGENT TYPE in use. Call Service.
N°141 FLUE	Stops oven	SPI-FLASH memory writing error	Error during SPI-FLASH memory writing.	<ul style="list-style-type: none"> <li>• Switch OFF and ON the oven, if the problem persists, call Service.</li> </ul>
N°142 FLEE	Stops oven	SPI-FLASH memory block erase error (4kb block)	Error during SPI-FLASH memory block erase.	<ul style="list-style-type: none"> <li>• Switch OFF and ON the oven, if the problem persists, call Service.</li> </ul>
N°145 FrrE	Stops oven	FRAM memory reading error	Error during FRAM memory reading.	<ul style="list-style-type: none"> <li>• Switch OFF and ON the oven, if the problem persists, call Service.</li> </ul>

<b>Anomaly</b>	<b>Type of anomaly</b>	<b>Description</b>	<b>Possible causes</b>	<b>Actions</b>
N°146 FrUE	Stops oven	FRAM memory writing error	Error during FRAM memory writing.	<ul style="list-style-type: none"> <li>Switch OFF and ON the oven, if the problem persists, call Service.</li> </ul>
N°150 USFO	Stops oven	Error during creation / opening of a file on the USB pen drive.	Error during creation / opening of a file on the USB pen drive.	<ul style="list-style-type: none"> <li>Try with another USB pen drive.</li> </ul>
N°151 USFC	Stops oven	Error during closure of a file on the USB pen drive	Error during closure of a file on the USB pen drive.	<ul style="list-style-type: none"> <li>Try with another USB pen drive.</li> </ul>
N°152 USrE	Stops oven	Error during reading of a file on the USB pen drive	Error during reading of a file on the USB pen drive.	<ul style="list-style-type: none"> <li>Try with another USB pen drive.</li> </ul>
N°153 USUE	Stops oven	Error during writing of a file on the USB pen drive	Error during writing of a file on the USB pen drive.	<ul style="list-style-type: none"> <li>Try with another USB pen drive.</li> </ul>
N°154 USdC	Stops oven	Error during creation of a directory on the USB pen drive	Error during creation of a directory on the USB pen drive.	<ul style="list-style-type: none"> <li>Try with another USB pen drive.</li> </ul>
N°155 USFU	Stops oven	Impossible to write on the USB pen drive: USB pen drive full	Impossible to write on the USB pen drive: USB pen drive full.	<ul style="list-style-type: none"> <li>Try with another USB pen drive.</li> </ul>
N°E160 nIU1	Warning Stops only connectivity	Communication impossible with NIU board	The UI is not able to communicate with the NIU, once the parameter 352 has been enabled to 1	<ul style="list-style-type: none"> <li>Call service</li> </ul>
N°E161 nIUS	Warning Stops only connectivity	NIU SW version is incompatible with UI SW version.	Once the NIU has been installed, it has been recognized an incompatible software version of the NIU	<ul style="list-style-type: none"> <li>Call service</li> </ul>
N°E162 nIUH	Warning Stops only connectivity	NIU unknown	-	-
N°E163 nIUC	Warning Stops only connectivity	NIU configuration not valid	-	-
N°E164 nIUP	Warning Stops only connectivity	No valid PNC and SN found	-	-
N°200 ACUM	Stops oven	Main electronic board not identified	Communication problem with the main electronic board.	<ul style="list-style-type: none"> <li>Switch the oven OFF/ON;</li> <li>If the error persists, call Service.</li> </ul>
N°201 MCtM / FU13	Stops the oven	Upper inverter communication problem	<ul style="list-style-type: none"> <li>Issue with the motor inverter;</li> <li>Connection or electrical issue,</li> </ul>	<ul style="list-style-type: none"> <li>Communication error with upper cavity motor inverter.</li> <li>Try to switch the oven OFF/ON.</li> <li>If the problem persists, call Service.</li> </ul>
N°202 MCbM/ Fd13	Stops appliance.	Inverter bottom not identified (MD1).	<ul style="list-style-type: none"> <li>Issue with the motor inverter.</li> <li>Connection or electrical issue.</li> </ul>	<ul style="list-style-type: none"> <li>Communication error with bottom cavity motor inverter.</li> <li>Switch the oven OFF/ON.</li> <li>If the problem persists, call Service</li> </ul>
N°203 CPUA	Stops oven	ACS microprocessor does not communicate	ACU failure.	<ul style="list-style-type: none"> <li>Restart the oven;</li> <li>If the error persists, call Service.</li> </ul>
N°204 CPUt	Stops oven	TC microprocessor does not communicate	ACU failure.	<ul style="list-style-type: none"> <li>Restart the oven;</li> <li>If the error persists, call Service.</li> </ul>
N°205 ACUP	Stops oven	Communication protocol error detected	The ACU has not been programmed correctly.	<ul style="list-style-type: none"> <li>Switch the oven OFF/ON;</li> <li>If the error persists, call Service.</li> </ul>

<b>Anomaly</b>	<b>Type of anomaly</b>	<b>Description</b>	<b>Possible causes</b>	<b>Actions</b>
N°210 EtC	Stops the oven	Cavity safety switch triggered (TSC)	<ul style="list-style-type: none"> <li>The cavity is dirty;</li> <li>The parameter COT is set too high;</li> <li>The safety thermostat bulb or the capillary are damaged;</li> <li>The motor fan is blocked while the heat is still On;</li> <li>The temperature TC sensor provides erratic measurements</li> <li>Leakage of heat in the safety thermostat body area.</li> <li>Room temperature &lt;5°C.</li> </ul>	Cavity over temperature reached. Call Service.
N°211 EtUC	Stops the oven	Cavity overtemperature	<ul style="list-style-type: none"> <li>The cavity is dirty;</li> <li>The parameter COT is set too low.</li> </ul>	<ul style="list-style-type: none"> <li>Launch a cooling cycle; if not possible open the door and let the oven to cool down; clean the cavity.</li> <li>When the temperature drops it is possible to launch a new cooking cycle.</li> <li>Starting SW revision 1.8.0, it is allowed to run a manual cool down when this alarm is present. If the problem persists, call Service.</li> <li>If the error shows up again call Service.</li> </ul>
N°212 ECEu	Stops cycle (unless the cycle running is a steam 100°C).	Upper cavity thermocouple failure	<ul style="list-style-type: none"> <li>Connector failure;</li> <li>TC sensor failure;</li> <li>ACU failure.</li> </ul>	The oven can continue to work only with 100 °C steam cycle. For restoring full functionality, call Service.
N°213 ECEd	Blocks cycle (unless the cycle running is a steam 100°C).	Bottom cavity thermocouple failure	<ul style="list-style-type: none"> <li>Connector failure;</li> <li>TC sensor failure;</li> <li>ACU failure.</li> </ul>	The oven can continue to work only with 100 °C steam cycle. For restoring full functionality, call Service.
N°220 Etb	Stops boiler cycles	Boiler safety thermostat trips. Overtemperature in the boiler.	<ul style="list-style-type: none"> <li>Missing water in the boiler;</li> <li>Limestone accumulation in the boiler;</li> <li>Wrong insertion of the TC probe sensor;</li> <li>The safety thermostat bulb or the capillary are damaged;</li> <li>Leakage of heat in the safety thermostat body area;</li> <li>The parameter BOT is set too high;</li> <li>Room temperature &lt;5° C.</li> </ul>	The oven is not able to produce steam with the boiler. An alternative device will be used, but the performance will be reduced; <ul style="list-style-type: none"> <li>Call service to restore the boiler functionality.</li> </ul>
N°221 EtUb	Stops boiler cycles	Boiler overtemperature	<ul style="list-style-type: none"> <li>Missing water in the boiler (electric heated appliances only);</li> <li>Limestone accumulation in the boiler;</li> <li>The parameter BOT is set too low.</li> </ul>	<ul style="list-style-type: none"> <li>Wait for the boiler temperature to cool down (alarm ETUB will disappear)</li> <li>Run the maintenance boiler cycle and use the quantity of C25 tabs indicated in F.9.9 <i>Boiler descaling (dESC cycle)</i> procedure of this Manual);</li> <li>In case the alarm re-appears, descale the boiler again.</li> <li>If the problem persists, call Service.</li> </ul>
N°222 EbOL	Stops cycle/ preheating	Boiler thermocouple failure	<ul style="list-style-type: none"> <li>Connector failure;</li> <li>TC sensor failure;</li> <li>ACU failure.</li> </ul>	The oven can continue to work without preheating (check the cooking results). <ul style="list-style-type: none"> <li>Inform Service about the failure.</li> </ul>

Anomaly	Type of anomaly	Description	Possible causes	Actions
N°223 BoLt	Stops cycle (if the cycle needs the boiler)	Boiler water loading timeout	<ul style="list-style-type: none"> <li>Water supply (pressure/ quality of water).</li> <li>Electric insulation problem with water level sensors.</li> </ul>	<ul style="list-style-type: none"> <li>Check if the water supply is open;</li> <li>Check if the water pressure is not too low;</li> <li>Verify if the water filter is clogged. Clean it or replace it;</li> <li>Mechanical problem with boiler operation. If the problem persists call Service.</li> </ul>
N°224 BEtr	Warning	Boiler excessive temperature raising time	The oven has detected a low performance in the boiler.	<ul style="list-style-type: none"> <li>It is possible to cook. Verify the cooking results.</li> <li>If the warning persists call Service.</li> </ul>
N°227 LPIn	Stops cycle	Boiler level sensor problem	<ul style="list-style-type: none"> <li>Humid lime shortcutting boiler level sensors.</li> <li>Insulation issues with the boiler level sensors</li> </ul>	<p>The oven can continue to operate in convection or in ISG mode.</p> <ul style="list-style-type: none"> <li>There is a problem with the water level in the boiler: run a cleaning program including the rinse and descale cycle and use 2 tabs C25 only. (Follow the procedure as per Operating Manual);</li> <li>If the problem persists, call Service.</li> </ul>
N°228 Hd05		Water solenoid valve EV5 not working. Boiler fill solenoid valve.		<ul style="list-style-type: none"> <li>Switch the oven OFF/ON;</li> <li>If the error persists, it is possible to cook in convection mode or in combi under 100°C mode.</li> <li>Automatic cleaning not working: manually clean/rinse the oven cavity and call Service to restore full functionality.</li> </ul>
N°229 Hd06	Stops cleaning.	Boiler drain valve BV6 not working.		<p>Switch the oven OFF/ON;</p> <p>If the error persists, manually clean/rinse the oven cavity and call Service</p>
N°230 dESC	Stops cycle (if the cycles needs the boiler).	Descalate boiler.	Parameter bSCu has been reached.	<p>Scale in the boiler. Run a cleaning program including the rinse and descale cycle using 2 tablets "C25" only.</p> <p>If the problem persists, call Service.</p>
N°231 dESS	Warning	Descalate boiler	Parameter <b>bSct</b> (Boiler Scale build up threshold) has been reached.	<p>Scale in the boiler. Run a cleaning program including the rinse and descale cycle using 2 tablets "C25" only.</p> <p>If the problem persists, call Service.</p>
N°240 Bhto	Only logged	Warning on excessive time on opening operation of the vent valve during cooking (VV1).	<ul style="list-style-type: none"> <li>Flap (venting valve) motor reducer or micro switch failure.</li> <li>Obstruction at the venting valve inlet.</li> </ul>	<p>It is possible to continue using the oven. Cooking results maybe different from usual.</p> <ul style="list-style-type: none"> <li>With the oven OFF and cold, check if any obstruction at the ventilation chimney on the top of the oven: remove the obstruction if any;</li> <li>If the problem persists, call Service.</li> </ul>
N°242 BEto	Stops cleaning	Error, excessive time on opening operation of the vent valve during cleaning	Mechanical or electrical problem with vent valve.	<p>The oven has detected a problem with cavity vent operation. It is not possible to perform/ complete the cleaning cycle. Switch OFF/ON for resetting the error.</p> <p>If the cleaning does not restart, call Service.</p>
N°243 BEtc	Warning	Error, excessive time on closing operation of the vent valve during cleaning	Mechanical or electrical problem with vent valve.	<p>The oven has detected a problem with cavity vent operation. If cooking: check the cooking result, try to reset the message also switching OFF/ON; if message persists, call Service and continue cooking: clean the oven only manually until fixing the issue.</p> <p>If cleaning: it is not possible to perform/complete the cleaning cycle. Switch OFF/ON to reset the message. If the problem persists, call Service.</p>
N°244 Y8	Warning	Blocks cleaning if the flap is closed	<p>The oven has detected a problem with cavity vent operation. It is not possible to perform/complete the cleaning cycle.</p> <p>Call service</p>	<p>The oven has detected a problem with cavity vent operation. It is not possible to perform/ complete the cleaning cycle.</p> <p>Call Service</p>

<b>Anomaly</b>	<b>Type of anomaly</b>	<b>Description</b>	<b>Possible causes</b>	<b>Actions</b>
N°252 Htd	Stops oven	Drain temperature above safety limit	Possible lack of water in the drain system.	<ul style="list-style-type: none"> <li>• Check that the oven has water supply;</li> <li>• Pour some fresh water on the bottom cavity filter; pay attention, do not splash hot cavity with cold water as it could damage the appliance.</li> <li>• Wait for the alarm to blink off;</li> <li>• If the problem persists, call Service.</li> </ul>
N°253 EStd	Stops appliance.	Water drain NTC failure	<ul style="list-style-type: none"> <li>• Connector failure</li> <li>• NTC sensor failure</li> <li>• ACU failure</li> </ul>	<ul style="list-style-type: none"> <li>• Call Service to fix the issue.</li> </ul>
N°254 Hd02	Warning	Water solenoid valve EV2 not working Quenching valve.		Switch the oven OFF/ON; If the error persists, pour 1 litre of water in the cavity every 30 mins to avoid overheating on the rubber pipings and call Service.
N°260 Cdo	Stops cleaning Warning in cooking	Cleaning drawer cap absent	<ul style="list-style-type: none"> <li>• The cap of the cleaning drawer is not detected; it is not possible to FINISH a cooking or cleaning cycle.</li> </ul>	<p>The oven can continue to cook but cleaning cycle could not be performed until the drawer cap will be in place;</p> <ul style="list-style-type: none"> <li>• Screw correctly the cap on the cleaning drawer in the front of the oven;</li> <li>• If the error persists, rotate the cap 180° and screw again. Call Service.</li> </ul>
N°261 Hd07	Stops cleaning.	Water solenoid valve EV7 not working.		Switch the oven OFF/ON; If the error persists, manually clean/rinse the oven cavity and call Service
N°262 Hd11	Stops cleaning.	Water solenoid valve EV11 not working.		Switch the oven OFF/ON. If the error persists, manually clean/rinse the oven cavity and call Service.
N°263 Hd12	Stops cleaning.	Water solenoid valve EV12 not working		Switch the oven OFF/ON. If the error persists, manually clean/rinse the oven cavity and call Service.
N°264 Hd08	Stops cleaning.	Cleaning pump M8 not working.		Switch the oven OFF/ON. If the error persists, manually clean/rinse the oven cavity and call Service.
N°265 HdPP	Stops liquid cleaning	Valves/pumps activations (ACS feedback)		<ul style="list-style-type: none"> <li>• Switch OFF and ON the oven, if the error persists, manually clean the oven cavity and call Service.</li> </ul>
N°280/ 281 HFnl	Stops humidifier	Humidifier not working	<ul style="list-style-type: none"> <li>• Water missing;</li> <li>• ISG circuit obstruction.</li> </ul>	<p>The oven has detected a problem with the humidifier (ISG). It could be possible to cook in convection mode only.</p> <p>Verify the water supply valve is fully open and the water filler has no obstructions. Clean it if needed.</p> <p>If the problem persists, call Service.</p>
N°282 Hd01	Boiler malfunction	Boiler malfunction For boilerless stops humidification. For boiler stops humidification and combi cycles under 100°C	The solenoid valve is not working.	Switch the oven OFF/ON. If the error persists, manually clean/rinse the oven cavity and call Service.
N°290 EntC	Stops oven	component compartment NTC failure	<ul style="list-style-type: none"> <li>• Connector failure;</li> <li>• TC sensor failure;</li> <li>• ACU failure.</li> </ul>	Electronic board temperature sensor damaged. Cooking impossible. <ul style="list-style-type: none"> <li>• Call Service.</li> </ul>
N°291 ESCH	Stops oven, except cooling fan.	Component compartment overtemperature	<ul style="list-style-type: none"> <li>• Filter is dirty;</li> <li>• Too high room temperature.</li> </ul>	<ul style="list-style-type: none"> <li>• Check room temperature considering the oven needs fresh air to cool electronic compartment;</li> <li>• Clean the filter;</li> <li>• Allow oven to cool before cooking;</li> <li>• Call Service if the problem reoccurs.</li> </ul>

Anomaly	Type of anomaly	Description	Possible causes	Actions
N°292 ASCH	Warning	Component compartment temperature warning (NCC).	<ul style="list-style-type: none"> <li>Filter is dirty;</li> <li>Too high room temperature.</li> </ul>	<ul style="list-style-type: none"> <li>Check room temperature considering the oven needs fresh air to cool electronic compartment.</li> <li>Clean the filter;</li> <li>Allow oven to cool before cooking;</li> <li>If the problem persists, call Service.</li> </ul>
N°300 GbCU	Cycle paused	Cavity upper burner locked	<ul style="list-style-type: none"> <li>Air in gas supply;</li> <li>Gas supply is closed;</li> <li>Issue with the electric supply of the burner system;</li> <li>Burner system internal failure;</li> </ul>	<p>The oven will not operate until restoring the burner functionality.</p> <p>To recover the functionality:</p> <ul style="list-style-type: none"> <li>If the error occurs at the cycle start, switch the oven OFF/ON.</li> <li>If the error occurs after 5 ignition attempts: <ol style="list-style-type: none"> <li>check the gas supply main valve is open</li> <li>reset the error and attempt new cycle</li> <li>if the error persists, switch OFF/ON the oven and attempt new cycle again;</li> </ol> </li> </ul> <p>If the problem persists, call Service</p>
N°301 GbCd	Cycle paused.	Cavity lower burner locked.	<ul style="list-style-type: none"> <li>Air in gas supply;</li> <li>Gas supply is closed;</li> <li>Issue with the electric supply of the burner system;</li> <li>Burner system internal failure;</li> </ul>	<p>The oven can continue to work both in convection and ISG mode.</p> <p>To recover full boiler functionality:</p> <ul style="list-style-type: none"> <li>If the error occurs at the cycle start, switch the oven OFF/ON.</li> <li>If the error occurs after 5 ignition attempts: <ol style="list-style-type: none"> <li>check the gas supply main valve is open</li> <li>reset the error and attempt new cycle</li> <li>if the error persists, switch OFF/ON the oven and attempt new cycle again;</li> </ol> </li> </ul> <p>if the problem persists, call Service</p>
N°302 GbbU	Blocks boiler.	Boiler gas burner locked	<ul style="list-style-type: none"> <li>Air in gas supply;</li> <li>Gas supply is closed;</li> <li>Issue with the electric supply of the burner system;</li> <li>Burner system internal failure;</li> </ul>	<p>The oven will not operate until restoring the burner functionality.</p> <p>To recover the functionality:</p> <ul style="list-style-type: none"> <li>If the error occurs at the cycle start, switch the oven OFF/ON.</li> <li>If the error occurs after 5 ignition attempts: <ol style="list-style-type: none"> <li>check the gas supply main valve is open</li> <li>reset the error and attempt new cycle</li> <li>if the error persists, switch OFF/ON the oven and attempt new cycle again;</li> </ol> </li> </ul> <p>If the error persists, call Service</p>
N°310 CntC	Stops cooking	Cavity SSR NTC failure (NTC3)	<ul style="list-style-type: none"> <li>Connector failure;</li> <li>NTC sensor failure;</li> <li>ACU failure;</li> </ul>	<ul style="list-style-type: none"> <li>Restart the oven;</li> <li>If the error persists, call Service.</li> </ul>
N°311 CSOt	Stops appliance.	Cavity SSR NTC overtemperature (NTC3)	<ul style="list-style-type: none"> <li>Inlet air filter dirty;</li> <li>Cooling fan failure;</li> <li>Cooling inlet air sucking warm/hot air;</li> <li>Oven installed by hot appliance;</li> <li>Steam/Heat leakage in the electronic compartment;</li> </ul>	<p>The oven can continue to work in recovery mode: cooking cycles will not use the boiler.</p> <ul style="list-style-type: none"> <li>Do not switch the oven OFF;</li> <li>Wait for the temperature to decrease;</li> <li>Clean the inlet air filter;</li> <li>Check with a thin strip of paper whether a consistent air flow can be detected at the cooling air inlet: if not, call service;</li> <li>Check if the inlet cooling air may be affected by heat produced in the kitchen (in case the oven is located by hot appliances, stop working with those appliances and inform Service);</li> <li>If the error persists, call Service.</li> </ul>
N°313 bntC		Boiler SSR NTC failure (NTC4)	Temperature sensor issue.	<p>The oven has detected a problem with boiler operation. It is possible to continue cooking without the boiler functionality.</p> <ul style="list-style-type: none"> <li>Verify cooking results;</li> <li>If the problem persists, call Service.</li> </ul>

Anomaly	Type of anomaly	Description	Possible causes	Actions
N°314 BSOt		Boiler SSR NTC over-temperature (NTC4)	<ul style="list-style-type: none"> <li>Inlet air filter dirty;</li> <li>Cooling fan failure;</li> <li>Cooling inlet air sucking warm/hot air;</li> <li>Oven installed by hot appliance,</li> <li>Steam/Heat leakage in the electronic compartment.</li> </ul>	<p>The oven can continue to work in recovery mode: cooking cycles will not use the boiler.</p> <ul style="list-style-type: none"> <li>Do not switch the oven Off;</li> <li>Wait for the temperature to decrease;</li> <li>Clean the inlet air filter;</li> <li>Check with a thin strip of paper whether a consistent air flow can be detected at the cooling air inlet: if not, call service;</li> <li>Check if the inlet cooling air may be affected by heat produced in the kitchen (in case the oven is located by hot appliances, stop working with those appliances and inform Service);</li> <li>If the error persists, call Service.</li> </ul>
N°320 Eprb1	Stops only food probe cycles	Single point core probe failure	<ul style="list-style-type: none"> <li>Food probe misuse (for example, wire pulled or squeezed);</li> <li>Connector failure;</li> <li>Probe failure;</li> <li>ACU failure.</li> </ul>	<p>It is possible to run cycles based on time (without food probe);</p> <ul style="list-style-type: none"> <li>If available, use the accessory USB food probe;</li> <li>Call service to restore full functionality.</li> </ul>
N°321 Epr6	Stops only food probe cycles	Six points core probe failure	<ul style="list-style-type: none"> <li>Food probe misuse (for example, wire pulled or squeezed);</li> <li>Connector failure;</li> <li>Probe failure;</li> <li>ACU failure.</li> </ul>	<p>It is possible to run cycles based on time (without food probe);</p> <ul style="list-style-type: none"> <li>If available, use the accessory USB food probe;</li> <li>Call service to restore full functionality.</li> </ul>
N°322 ELMb	Stops all cycles except convection without humidity control and steam under 100°C.	Detected a problem with the oxygen sensor	<ul style="list-style-type: none"> <li>Lambda probe failure.</li> </ul>	<p>Oven has detected a problem with lambda probe. It is possible to continue using the oven in Steam under 100°C.</p> <p>Cooking results in Steam mode may be different from usual.</p> <p>For restoring full functionality, call Service.</p>
N°324 FA8H	After ending cooking cycle, stops oven cooking	Oven worked 8 hours without air inlet filter	Misuse	Restore the air inlet filter checking its cleanness before fitting it back in place. In case the filter is lost, call Service
N°325 GrCo	Stops cleaning cycle	Grease collector valve opened	Misuse	Ensure to close the grease collector drain valve before restarting the cleaning cycle.
N°326 Hd03	Stops appliance.	Cavity drain valve BV3 not working.		Switch the oven OFF/ON. If the error persists, call Service.
N°327 EH2O	Stops oven	Water measured inconsistent with valves state	<ul style="list-style-type: none"> <li>Water supply valve closed or partly closed;</li> <li>Temporary lack of water supply pressure;</li> <li>Flow meter failure;</li> <li>Water system issue.</li> </ul>	<p>The oven can continue to work (check the cooking results).</p> <ul style="list-style-type: none"> <li>Check if the water supply valve is open;</li> <li>Check the water pressure is &gt; 1,5 bar;</li> <li>If the problem, persists call Service.</li> </ul>
N°329 H2OC	Warning	H2O check. The oven retry the water check 3 times every 10 mins. After that, EH2O is shown	<ul style="list-style-type: none"> <li>Water tap is closed</li> <li>Water flow rate less than 1 l/min</li> <li>No signal feedback from flowmeter</li> </ul>	<ul style="list-style-type: none"> <li>Check water tap is open</li> <li>check water pressure is good</li> <li>if the problem persists for 30 min and EH2O rises, call Service</li> </ul>
N°400 FU00	Stops appliance.	Upper motor short circuit.	<ul style="list-style-type: none"> <li>Pinched wire (line between inverter and motor).</li> <li>Short circuit phase to phase.</li> <li>Short circuit phase to ground.</li> <li>Inner electric motor shortcut.</li> </ul>	Call Service.

<b>Anomaly</b>	<b>Type of anomaly</b>	<b>Description</b>	<b>Possible causes</b>	<b>Actions</b>
N°401 FU01	Stops appliance.	Upper motor overcurrent.	All causes related to friction phenomena: <ul style="list-style-type: none"> <li>• Cavity fan towards suction wall.</li> <li>• Motor shaft towards graphitic ring.</li> </ul>	Restart oven. If the causes persist, error will appear again, call Service.
N°402 FU02	Stops appliance.	Upper motor speed inconsistency.	<ul style="list-style-type: none"> <li>• Wrong motor parameter.</li> <li>• Phase not connected.</li> <li>• Excessive friction (see FU01).</li> </ul>	Restart oven. If the causes persist, error will appear again, call Service.
N°403 FU03	Stops appliance.	Upper inverter under voltage DC.	Internal issue with the inverter hardware.	Restart oven. If the causes persist, error will appear again, call Service.
N°404 FU04	Stops appliance.	Upper inverter overvoltage.	<ul style="list-style-type: none"> <li>• External power supply fluctuation.</li> <li>• Internal issue with the inverter hardware.</li> </ul>	Check the power supply is stable (check functionality of other units nearby the oven). Restart oven. If the causes persist, error will appear again, call Service.
N°405 FU05	Stops appliance.	Upper inverter outgoing phases open circuit.	Defective / unplugged connector on inverter.	Call Service.
N°406 FU06	Stops appliance.	Upper inverter high temperature.	Wrong motor parameter. General overheating of inner components.	Clean air inlet filter, let the unit to cool down. Restart oven. If the causes persist, error will appear again, call Service.
N°407 FU07	Stops appliance.	Upper motor thermostat safety tripping (Klixon)	All causes related to friction phenomena: <ul style="list-style-type: none"> <li>• Cavity fan towards suction wall.</li> <li>• Motor shaft towards graphitic ring.</li> <li>• Cleaning cycle with excessive water load.</li> </ul>	If in cooking phase: wait for the motor to cool down. Restart the oven after 30 mins. If the problem persists call Service. If in cleaning phase: call Service
N°408 FU08	Stops appliance.	Upper inverter over torque	All causes related to friction phenomena: <ul style="list-style-type: none"> <li>• Cavity fan towards suction wall</li> <li>• Motor shaft towards graphitic ring.</li> </ul>	Restart oven. If the causes persist, error will appear again, Call Service.
N°409 FU09	Stops appliance.	Upper inverter interlock circuit failure	Internal inverter hardware issue	Call Service
N°410 FU10	Stops appliance.	Upper inverter drive interlock failure	Inverter hardware/harness issue	Call Service
N°411 FU11	Stops appliance.	Upper inverter under-voltage AC	External power supply fluctuation	Check the power supply is stable (check functionality of other units nearby the oven). Restart oven. If the causes persist, error will appear again, call Service.
N°412 FU12	Stops appliance.	Upper inverter over-voltage AC	Issue with external power supply	Call Service. It might be required to call the electric power supply provider.
°413 FU13	Stops appliance.	Upper inverter communication Error.	Inverter power supply (AC) missing. Connector unplugged/damaged. Fuse F2 blown.	Restart oven. If the causes persist, error will appear again, call Service
°414 FU14	Stops appliance.	Upper inverter parameter configuration Error.	Lower inverter wrong parameters.	Call Service.
°417 FU17	Stops appliance.	Upper inverter outgoing phases open circuit	Defective / unplugged connector on inverter	Call Service

<b>Anomaly</b>	<b>Type of anomaly</b>	<b>Description</b>	<b>Possible causes</b>	<b>Actions</b>
°450 Fd00	Stops appliance.	Lower motor short circuit.	Pinched wire (line between inverter and motor). Short circuit phase to phase. Short circuit phase to ground. Inner electric motor shortcut.	Call Service.
°451 Fd01	Stops appliance.	Lower motor overcurrent.	All causes related to friction phenomena: <ul style="list-style-type: none"> <li>• Cavity fan towards suction wall.</li> <li>• Motor shaft towards graphitic ring.</li> </ul>	Restart oven, if the causes persist, error will appear again, call Service.
°452 Fd02	Stops appliance.	Lower motor speed inconsistency.	Wrong motor parameter. Phase not connected. Excessive friction (see FU01).	Restart oven. If the causes persist, error will appear again, call Service.
N°453 Fd03	Stops appliance.	Lower inverter under-voltage DC.	Internal issue with the inverter hardware.	Restart oven. If the causes persist, error will appear again, call Service
N°454 Fd04	Stops appliance.	Lower inverter overvoltage	External power supply fluctuation. Internal issue with the inverter hardware.	Check the power supply is stable (check functionality of other units nearby the oven). Restart oven, if the causes persist, error will appear again, call service.
N°455 Fd05	Stops appliance.	Lower inverter outgoing phases open circuit.	Defective / unplugged connector on inverter.	Call Service.
N°456 Fd06	Stops appliance	Upper Inverter outgoing phases open circuit.	Wrong motor parameter. General overheating of inner components.	Clean air inlet filter, let the unit to cool down. Restart oven, if the causes persist, error will appear again, call service
N°457 Fd07	Stops appliance.	Upper motor thermostat safety tripping (Klixon).	All causes related to friction phenomena: <ul style="list-style-type: none"> <li>• Cavity fan towards suction wall.</li> <li>• Motor shaft towards graphitic ring.</li> <li>• Cleaning cycle with excessive water load.</li> </ul>	If in cooking phase: wait for the motor to cool down. Restart the oven after 30 mins. If the problem persists, call service. If in cleaning phase: call service.
N°458 Fd08	Stops appliance.	Upper motor thermal safety tripping (Klixon).	All causes related to friction phenomena: Cavity fan towards suction wall. Motor shaft towards graphite ring. All causes related to friction phenomena: <ul style="list-style-type: none"> <li>• Cavity fan towards suction wall.</li> <li>• Motor shaft towards graphitic ring.</li> </ul>	Restart oven. If the causes persist, error will appear again, call Service.
N°459 Fd09	Stops appliance.	Lower inverter drive interlock failure.	Inverter hardware issue.	Call Service.
N°460 Fd10	Stops appliance	Upper inverter drive interlock failure	Inverter hardware/ harness issue.	Call Service.
N°461 Fd11	Stops appliance.	Upper inverter under-voltage AC	External power supply fluctuation.	Check the power supply is stable (check functionality of other units nearby the oven). Restart oven, If the causes persist, error will appear again, call Service
N°462 Fd12	Stops appliance.	Lower Inverter under-voltage AC	External power supply fluctuation	Check the power supply is stable (check functionality of other units nearby the oven). Restart oven, if the causes persist, error will appear again, call Service.

<b>Anomaly</b>	<b>Type of anomaly</b>	<b>Description</b>	<b>Possible causes</b>	<b>Actions</b>
N°463 Fd13	Stops appliance.	Lower Inverter Comm Err	Inverter power supply (AC) missing. Connector unplugged and/or damaged. Fuse F2 blown.	Restart oven. If the causes persist, error will appear again, call Service
N°464 Fd14	Stops appliance.	Lower inverter Param Conf Err	Lower inverter wrong parameters configuration Error.	Call Service
N°467 Fd17	Stops appliance.	Lower Inverter output phase open	Defective / un-plugged connector on inverter	Call Service
N°600 Hod0	Hood level 2 Electric oven: Warning Hood level 2 gas oven: stops oven Hood level 3,4 (Electric only): Warning	Level 2, 3, 4: Malfunction on hood motor regulator	Hood's Electrical power supply off <ul style="list-style-type: none"><li>Hood Fan safety thermostat over temperature</li><li>Automatic Controller damage</li><li>Hood/oven interface cable disconnected or damaged</li></ul>	Restart oven. If the causes persist, error will appear again, Call service.
N°601 hod1	Warning	Level 4 only: Hood's UV lamp compartment open	UVC lamp's cassette are not in right position	Restart oven. If the causes persist, error will appear again, call service.
N°602 Hod2	Warning	Level 4 only: Hood's UV lamp compartment open	The cover panel of central technical compartment (UVC) is not in appropriate position or is not properly closed	Restart oven. If the causes persist, error will appear again, call service.
N°603 Hod3	Warning	Level 4 only: Hood's water separator filter missing	The demister and water separator filter are not in appropriate position	Restart oven. If the causes persist, error will appear again, call service.
N°604 hod4 Hod4	Warning	Level 4 only. Hood's electrical internal error (CN6). [Actually unused. This error is electrically bypassed in the hood control board].		
N°605 hod5	Warning	Level 4 only: Hood's lamp 1 missing or not working	Hood's UVC lamp 1 and/or 2 missing or not working	Restart oven. If the causes persist, error will appear again, call service.
N°606 hod6	Warning	Level 4 only. Hood's lamp 2 missing or not working.	Hood's UVC lamp 3 and/or 4 missing or not working	Restart oven. If the causes persist, error will appear again, call Service.
N°607 hod7	Warning	Level 4 only. Hood's ozone sensor 1 limit exceeded [Pre-disposition only. Ozone sensor currently not in use].		
N°608 hod8	Warning	Level 4 only. Hood's ozone sensor 2 limit exceeded [Pre-disposition only. Ozone sensor currently not in use].		
°609 hod9	Blocks oven	Hood connection lost	Triggered when no communication with the hood is reported by the ACU.	

Anomaly	Type of anomaly	Description	Possible causes	Actions
N°610 HodU	Stops oven	its not possible to start a cooking nor cleaning cycle if this happens during a cooking cycle this will be interrupted if this happens during a cleaning cycle this will be suspended until the alarm is cleared	Refer to the Service Manual of the hood.	Check that the hood is power supplied
N°620 UPrb	Blocks cycle if USB probe is used	USB Food probe missing or removed during cooking	The USB food probe is not correctly plugged	Restart oven. Check if the probe is inserted correctly into USB slot. If the causes persist, error will appear again, call Service.
N°1001	Stops appliance		The cavity is dirty; The parameter COT is set too low.	Launch a cooling cycle; if not possible open the door and let the oven to cool down; clean the cavity. When the temperature drops it is possible to launch a new cooking cycle. If the problem persists, call Service.

## I FURTHER INFORMATION

### I.1 Ergonomic features

#### I.1.1 Certification

The ergonomic features of your product, that may influence your physical and cognitive interaction with it, have been assessed and certified.

A product with ergonomic features, in fact, shall fulfil specific ergonomic requirements, belonging to three different areas: Polytechnic, Biomedical and Psychosocial (usability and satisfaction).

For each of these areas, specific tests with real users have been performed. The product is therefore compliant with the ergonomic acceptability criteria requested by the standards applied.

#### I.1.2 General recommendations

The oven or the blast chiller that you use is specifically studied and tested in order to minimise any physical problems associated to the interactions with the product.

The loading and unloading of the trays and the interaction with the product may bring to incongruous postures and handling of heavy weighs – characteristics of your daily activity that we tried to relieve.

In any case we would like to suggest a few operating procedures to adopt:

- Handle the tray in a balanced way, trying not to arch your back during the loading/unloading.
- If possible, flex your legs and don't bend forward your back during the placement of the trays in the lower shelves and during the achievement of any lower tools or items.
- If possible, try to place the trays in the cavities considering their weighs, as suggested by the pictures below.
- If possible, push the tray holder trolley and pull it in order to reduce the distances.
- Keep the viewing distance in order to understand properly the information displayed in the display or to view the object in the cavity, reducing as much as possible the time spent with the eyes up (neck extensions).

**Suggested movement of trays according to their weights**

Try to place the trays into the cavities considering their weights as suggested by the pictures below.

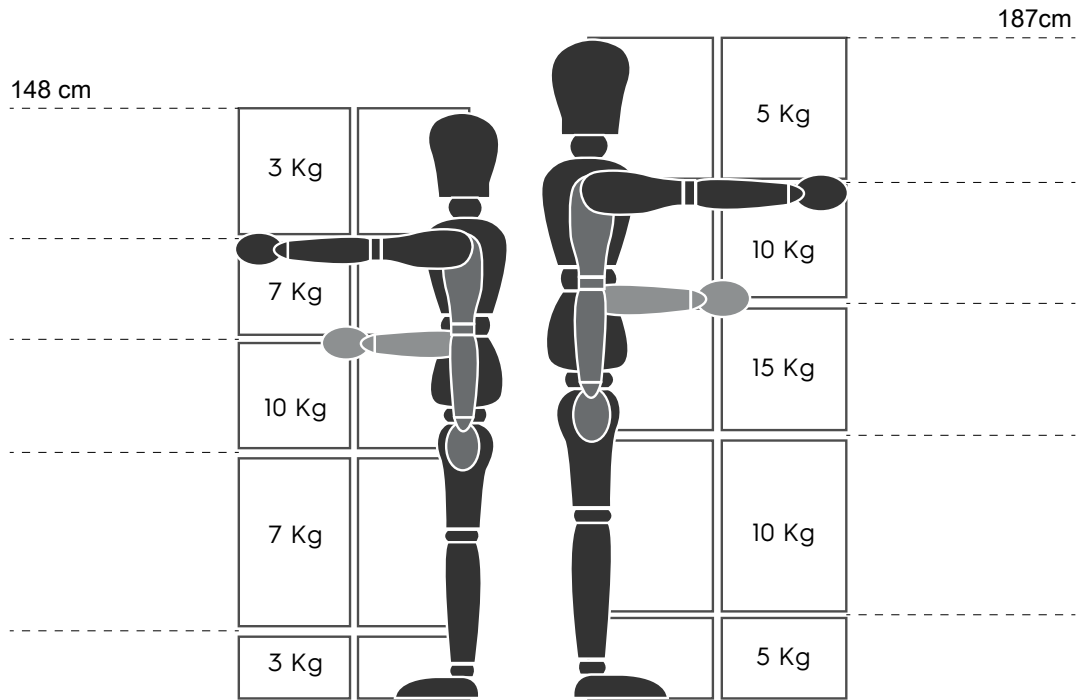

Maximum suggested weighs - "Manual Handling Operations Regulations" - Health and Safety Executive (HSE, UK, 2016)

**Below a few examples of common installations and the maximum suggested weights per trays**

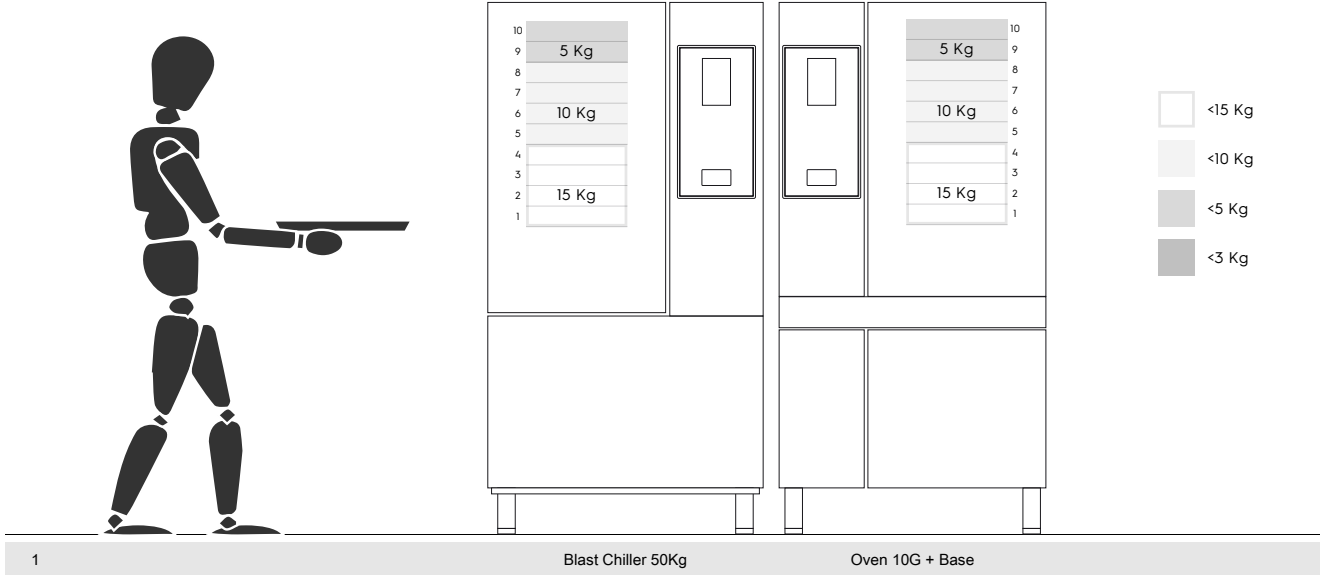

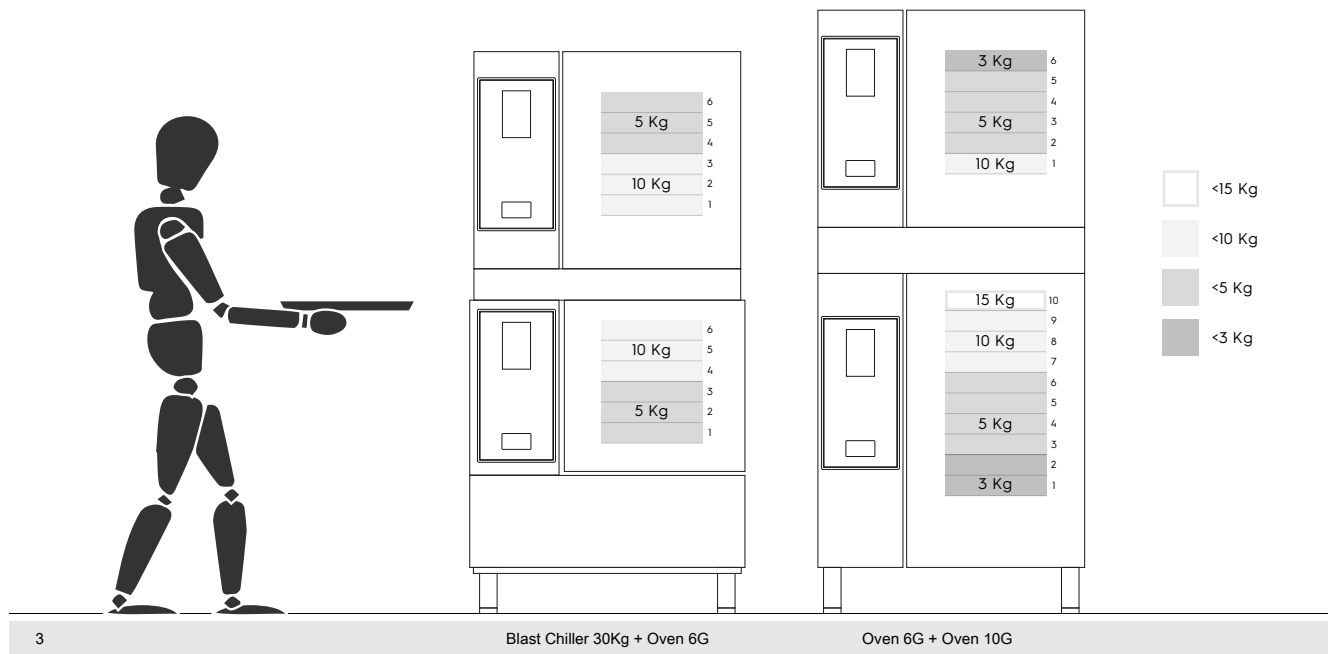

### I.1.2.1 Recommendations on accessories

- For the installation of the 180 Kg Blast Chiller it is suggested the predisposition of the isolated floor to avoid extra strain for the operator who uses the Mobile GastroNorm rack.
- For the wall installation of the 10GN it is suggested the use the Riser accessory not higher than 700 mm to improve easiness of loading.
- In the stacking installation 6GN + 6GN it is suggested to use the adjustable feet accessory 230-290mm (code 922745) and set them at maximum height of 290 mm to facilitate an easy loading.
- In the configuration 6GN + 6GN on Riser accessory it is suggested to load trays with a weight lower than 3 Kg on upper level.