



MOD :DLW40-TS/N

Production code : S40DDIELS1AIA03

10/2025

WASHING MACHINES

INSTRUCTIONS FOR USE MAINTENANCE AND INSTALLATION

TRANSLATION OF THE ORIGINAL INSTRUCTIONS
KEEP FOR FUTURE REFERENCE

INDEX SERVICE: 02

- DLW 14/18/23/26/32/40/55
- DRW 14/18/23/30



The manufacturer's data are shown
on the envelope it contains
the documentation of the machine.
The envelope is an integral part
of the documentation

Summary

1. CONTENTS OF THE MANUAL.....	3
2. SAFETY RULES	3
3. MANUFACTURER'S LIABILITY	5
4. TRANSPORT AND UNPACKING	5
5. MACHINE IDENTIFICATION	7
6a. INSTALLATION AND PLACEMENT	8
6b. INSTALLATION AND POSITIONING: ANNOTATIONS FOR ASEPTIC MACHINES.....	10
7. INFORMATION ON NOISE EMISSION.....	11
8. ELECTRICAL CONNECTION	11
9. HYDRAULIC CONNECTION: WATER LOADING.....	14
10. PLUMBING CONNECTION: WATER DRAIN	15
11. STEAM CONNECTION.....	15
12. COMPRESSED AIR CONNECTION	17
13. INTERNET CONNECTION	17
14. USE OF DETERGENTS.....	19
15. MACHINE START-UP AND TESTING, USER PASSWORD.....	19
16. THE EMERGENCY BUTTON	19
17. THE DETERGENT DRAWER	20
18. AIR VENTS.....	20
19. PREPARE YOUR GARMENTS.....	21
20. USE OF THE ASEPTIC MACHINE	21
21. LOAD THE MACHINE AND CLOSE THE DOOR	21
22. MANUAL OPENING OF THE DOOR AND ENGINE UNLOCK'	23
23. TURNING ON THE MACHINE.....	25
24. SELECTING A PROGRAM	26
25. RECENT PROGRAMS.....	27
26. DELAYED START	27
27. EXECUTION OF A PROGRAM.....	28
28. PAUSING A PROGRAM.....	29
29. FAST FORWARD	29
30. END OF EXECUTION OF A PROGRAM	29
31. END OF WORKING DAY	30
32. PROGRAMMING	31
33. COIN OP PROGRAMMING FOR SELF-SERVICE SYSTEMS.....	31
34. DISPLAY SIGNALS	33
35. PROGRAMS IN MEMORY	35
36. OTHER FUNCTIONS	36
37. MAINTENANCE OF THE WASHING MACHINE.....	36
38. WASHING PROBLEMS	37
39. USING THE TILTING MACHINE.....	37
40. EASY DOWNLOAD.....	39
41. PROCEDURE FOR CHECKING SAFETY DEVICES	39
42. SCRAPPING	39
43. WARRANTY CONDITIONS	40

1. CONTENTS OF THE MANUAL

This manual is dedicated to the description of the use, maintenance and installation of industrial washing machines. It is drawn up in accordance with the Community directives in force. The information is addressed to the installer and the user, who must be sure that they have fully understood it before operating the machine. The user manual must be available for consultation at all times. In case of loss or damage, ask the manufacturer for a new manual. The manufacturer is not responsible for the consequences of careless use of the machine due to a failure or incomplete reading of this manual. The manufacturer reserves the right to modify the specifications mentioned in this manual or the characteristics of each machine. Some figures in this manual may show details that are partially different from those assembled on the machines. Drawings and technical data are subject to change without notice.

This manual is supplemented by the following annexes: EU declaration of conformity, technical data sheet and wiring diagram. All documents are contained in an envelope that accompanies the machine. The wiring diagram, depending on the versions of the machine, is contained inside the electrical panel

The manual and its attachments are an integral part of the appliance: therefore they must be kept and accompany the appliance, even in the event of transfer to another user.

The manual, the same attachments and the exploded view with the relative spare parts, can be found in the technical area of the manufacturer's website. Before accessing the site, it is essential to have the serial number of the machine available.



ATTENTION!

The manufacturer declines all responsibility for possible inaccuracies contained in this manual due to printing, transcription or translation errors. It reserves the right to make any changes to its products as it deems necessary or useful, without affecting its essential characteristics. It is forbidden to reproduce, even partially, texts or images from this manual, without the prior authorization of the manufacturer.

This manual is also available in electronic format on the manufacturer's website (technical area).

2. SAFETY RULES



ATTENTION!

Risk of suffocation, injury or permanent disability!

Failure to comply with the following safety rules may result in damage to persons, property and animals.

The installation and maintenance of the machines described in this manual must be carried out by authorized personnel who are familiar with the product and compliance with European standards in the sector. Improperly repaired repairs can seriously endanger the safety of the user.

Before using the machine, read these instructions carefully: make the instructions accessible to all persons responsible for operating the machine.

The intended use of the washing machines described here is the professional washing of water-based clothing and linen: any other intended use is therefore forbidden unless previously authorized in writing by the manufacturer. Never use dry cleaning products.

It is forbidden to wash garments that are soaked in substances that are manifestly harmful to the health of operators, poisons or carcinogenic products.

It is forbidden to use the machine for children under 16 years of age.

Do not spray or wash the machine with water.

Do not override the door lock.

Do not let children play with or in the washing machine. Children should be kept under close supervision when near the washing machine.

Keep packaging materials out of the reach of children.

Keep detergents or chemicals out of the reach of children.

Keep children and pets away from the appliance door when it is open and the machine is running.

Additional connections to the machine from the outside, which are not carried out in a professional manner, relieve the manufacturer of any liability.

IMPORTANT SAFEGUARDS



CRUSHING HAZARD

It is forbidden to work with machine guards removed!

Always check that the safety devices are working correctly every time the machine is started! Each time you start-up, carry out the check procedure described in the relevant paragraph.

It is mandatory to know the operation of the machine and its emergency systems!

It is forbidden to introduce bars, slats or metal objects inside the basket. In the event of an emergency, always follow the procedures described below.

Machines with heating systems pose a potential risk of fire. All precautions related to this risk must therefore be taken: the environment must be free of combustible materials; Provide a suitable and easily accessible fire extinguisher near the machine.



BURN HAZARD

The machine, due to the very nature of the activity for which it is intended, presents the danger of burns.

Burns can be caused by:

- From the contact with the fabric coming out of the machine;
- From prolonged contact with the door when performing a high-temperature wash;
- From contact with the components that convey the steam

CAREFULLY READ AND INFORM ALL OPERATORS ABOUT THE INTERVENTION SYSTEMS IN THE EVENT OF A SUDDEN POWER FAILURE



ELECTROCUTION HAZARD

Any work on the electrical parts of the machine must only be carried out by qualified personnel and after the power supply to the machine has been disconnected.

The power and control circuits may only be tampered with by the manufacturer's personnel, otherwise the warranty conditions will be void.

It should be noted that, with reference to electrical hazards, the machine has been designed in compliance with the regulations described in the certificate of conformity delivered with the machine.

On the electrical panel there is the following monitor plate which must be replaced with an identical one if it has been damaged or removed.



ATTENTION

Even when the position of the main switch is "0", the cables upstream of the switch are live!



PSYCHOPHYSICAL CONDITIONS OF THE OPERATOR

The operator in charge of the machine must be in perfect psychophysical condition; During work, you must assume an upright posture in front of the machine. Abrupt movements or uncontrolled gestures, e.g. when picking up and inserting fabrics to be ironed, must be avoided in order to avoid dangerous collisions with the machine frame.

If other operators or other personnel are present, they must not be a source of distraction for the operator operating the machine.

While operating the machine, the operator must not be distracted by televisions, radios, etc., or be subject to any other source of distraction.



LIGHTING

In the room where the machine is installed, there must be uniform illumination with an intensity of 300-500 lux, annoying glare must also be avoided.



ATTENTION!

These warnings do not cover all possible risks. The user must therefore proceed with the utmost caution in compliance with the regulations.

3. MANUFACTURER'S LIABILITY

The instructions in this manual do not replace but supplement the obligations to comply with current legislation on safety and accident prevention regulations. With reference to what is reported in this manual, the manufacturer declines all responsibility in the event of:

- use of the machine contrary to current safety and accident prevention laws.
- incorrect installation of the machine.
- lack of periodic and scheduled maintenance.
- failure or incorrect adherence to the instructions provided in the manual.
- voltage and mains power supply defects.
- unauthorized modifications to the machine.
- use of the machine by unauthorized personnel.

4. TRANSPORT AND UNPACKING

During transport, and eventual storage, the equipment must remain within the following environmental conditions:

- Temperature: -10°C÷50°C
- Humidity: 0%÷90% (non-condensing)

It is recommended to check the machine upon receipt, taking care to report to the carrier any damage caused, during transport, both to the internal components and to the external bodywork.



ATTENTION!

During the handling phase, use a forklift with the forks as open as possible.



ATTENTION!

During the handling phase, the machine must remain in a horizontal position. The machine should never be placed in an upright position!

The machine must be completely unpacked near the installation location.

The strapping must be cut, and the cover wrap removed.

Packaging materials must not be dispersed in the environment and must be stored in the appropriate collection spaces according to current regulations.

Open both side doors with the supplied side key.

Use a wrench to remove the bolts securing the pallet, which are visible at the base of the right and left shoulder of the machine.



ATTENTION!

Check the net and gross weight on the technical data sheet, attached to the machine's documentation: check compatibility with the lifting equipment available.



ATTENTION!

The pallet should not be used as a normal machine holder! The machine must always be lowered from the pallet and positioned as described in the relevant paragraph.



ATTENTION!

The machine must be handled only when it is fixed to its pallet: handling and lifting by forklift must only be carried out by qualified and competent personnel.

During transport, the supercentrifugal machines are locked inside them (the cradle at the base) with stops, in order to avoid the stress of the shock absorbers.



ATTENTION!

The latches must be removed, after the machine has been placed and before it is powered.

To disassemble the latches, follow the procedure described below, referring to the figure. The figures are indicative of the type of stops and not of the machine.

- remove the rear and front panels;
- unscrew the bolts that lock the transport latches;
- disassemble ALL transport fasteners;
- reassemble the panels in their original position;

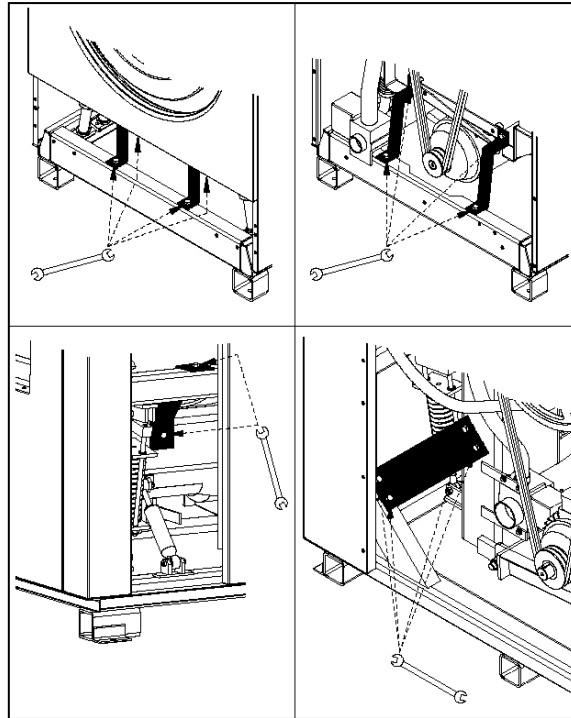

For "tilting" machines, operate as follows:

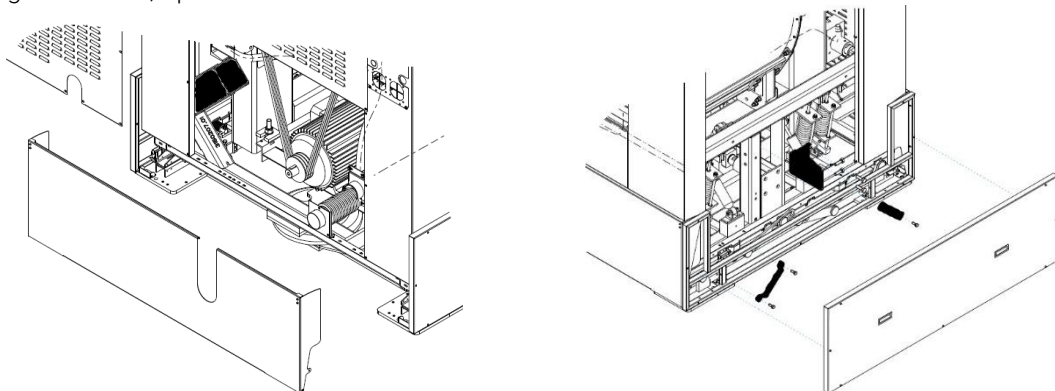

Remove the rear panel and the lower backrest, remove the transport latches.
Remove the side panel and side and remove the latches.

All panels must be reassembled in their original position, before the machine can be started. After removing them, the latches must be stored and reused whenever the machine needs to be transported. Transport stops are NOT PRESENT in rigid centrifugal washing machines.

5. MACHINE IDENTIFICATION

The equipment can be identified by means of an adhesive plate bearing the serial number, model, power and technical characteristics. Spare parts and/or interventions require the exact identification of the model for which they are intended.



Tampering, removal, lack of identification plates or anything else that does not allow the safe identification of the machine, makes any installation and maintenance operation difficult and automatically voids the warranty.

The washing machines described here are intended exclusively for washing textiles in water and are intended for the commercial, professional and industrial sectors.

MODELS AND MAXIMUM LOAD CAPACITY (ratio 1:10)	
SUPER CENTRIFUGE "S" CENTRIFUGE "R" ASEPTIC "H" TANDEM "O"	LOAD CAPACITY (Kg)
S8 – R8	8 (*)
S11 – R11 – O11	11 (*)
S14 – R14	14 (*)
S18 – R18 – O18	18 (*)
S23 – R23 – H23	23 (*)
S26	26 (*)
R30	30
H30	30
S32	32
S40 – R40	40
S55 – R55	55
H55	55
S70 – R70	70
S85 – R85	85
S100	100
S125	125

Some models with the capacities marked with (*) can be manufactured and equipped for installation in self-service shops with coin, token or other automatic payment systems. For some machines, the heating system is with hot water served.

6a. INSTALLATION AND PLACEMENT

All installation operations must be carried out by professionally qualified personnel.

Check that the floor capacity is compatible with the weight of the machine which can be detected from the attached data sheet. The load of the machine can be considered totally static. Make sure the floor is clean and heat-resistant.

For proper use, operation and maintenance, leave a clearance of at least 500 mm around the machine. The ambient temperature should be between +5°C and +40°C and the relative humidity should be 50%. The environment in which the machine is installed must have sufficient air exchange.

The degree of protection is IP24.

Do not install or operate the machine if it is damaged.

Correct operation is guaranteed up to altitudes of 1000 m above sea level.



ATTENTION!

Ensure that clean air is supplied to the machine and not air contaminated with chlorine, fluorine or other solvent vapours.

Do not use or store gasoline, oil, or other flammable materials in the vicinity of the machine. It may cause fire or explosion.

Provide a fire extinguisher in the vicinity of the machine, chosen and maintained according to current regulations.



ATTENTION!

The machine MUST NOT be installed outdoors, but in a CLOSED environment specifically built and used for laundry use.



ATTENTION!

In the case of tilting type machines, there are external elements of the machine itself, moving during the loading and unloading of the laundry.

For the overall dimensions of the machine and the moving elements in the different positions, refer to the data sheet.

Suspended high-spinning machines with a capacity of up to 32 kg do not need to be fixed to the ground. They are supplied with rubber feet that must be screwed to the relevant threaded holes on the base.

Incorrect adjustment of these feet can give rise to strong vibrations of the external structures of the machine. The machine must therefore be installed perfectly levelly on a floor that does not have an elastic reaction.

On the other hand, suspended supercentrifugal machines with a capacity of 30 kg or more must be fixed to the ground with dowels through the holes in the bases. The machines must be installed perfectly level, on a floor that does not have an elastic reaction.



ATTENTION!

It is forbidden to place elastic materials of any nature or size between the base of the machine and the floor.



ATTENTION!

Do not install the washing machine on the floors without verification by a competent technician who can assess the impact of the dynamic load on the floor and building.

In these installations, the manufacturer declines all responsibility for possible damage caused by vibrations.

Rigid washer-extractors must all be fixed to the ground.

If a steel subframe is available:

- The subframe must be embedded in a concrete base suitably anchored to the floor.
- Before anchoring the machine to the base, make sure that the concrete has set and, very importantly, that the subframe is perfectly level.
- Place the machine in the appropriate anchor holes and tighten all coupling bolts securely.

The dimensions of the counterframe and the concrete base can be found in the attached technical sheet.

If anchor anchors are available.



Steel anchor

Follow the steps below:

- Prepare the concrete base suitably anchored to the floor, according to the minimum dimensions indicated in the technical data sheet;
- Make sure that the concrete base is anchored to the floor, that it has gripped and that the surface made is perfectly level;
- Lower the machine off the pallet and place it in its final position on top of the concrete base;
- Using the open panels, mark on the concrete base the points where the steel anchors will be placed, corresponding to the holes in the metal base of the washing machine;
- Move the machine to clear the drilling areas;
- Drill at the points previously identified and according to the technical data contained in the following table.
- Clean up the holes you just made
- Reposition the machine so that the holes made match the holes in the washing machine base;
- Insert the steel anchors through the holes in the washing machine base, inside the holes made in the concrete

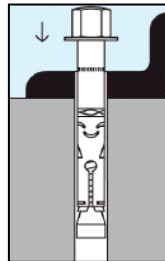

- Close the anchor to a value of 80Nm (for M12) with a torque wrench



ATTENTION!

For all installed rigid machines, carry out a test by having the washing machine run a spin cycle at full load (maximum speed and rated load), verifying that:

- there are no vibrations;
- there are no noises;
- there are no points of contact or sliding between the basket and the machine tank.

IMPORTANT: In the event that any of the problems listed above occur, it means that the machine has not been properly secured to the ground. Double-check:

- the correct levelling of the concrete base;
- the correct anchoring of the concrete base to the rest of the floor;
- the correct closure of the steel anchors.

6b. INSTALLATION AND POSITIONING: ANNOTATIONS FOR ASEPTIC MACHINES

In addition to all the indications given in the previous paragraph, for aseptic machines.

Aseptic machines are in fact equipped with a double door:

- a loading door, on the side of the IM11 touch screen: this is the "dirty side" door that must open in the room where the fabrics to be washed are brought
- an exhaust door, on the opposite side to the IM11: it is the "clean side" door that must open into the room where the washed and cleaned fabrics are unloaded

To carry out the installation correctly, it is necessary to have the technical data sheet of the machine available, which contains important information for the installer:

- minimum/maximum distance between the sides/lid of the machine and the wall separating the aseptic rooms
- Maximum size and correct positioning of the separation wall between aseptic rooms

- Connection points (water filling, detergent filling, draining, etc.) on the dirty side

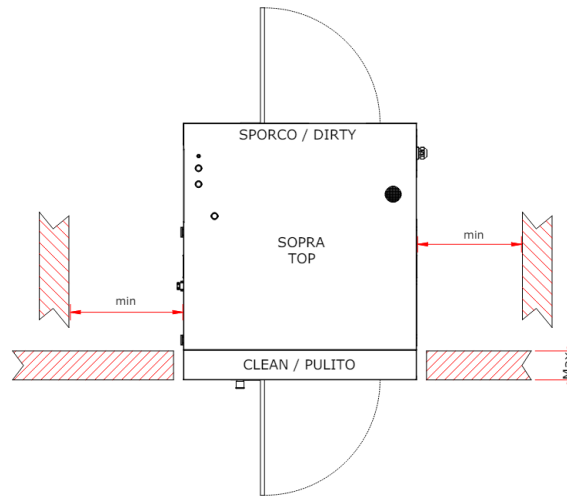

7. INFORMATION ON NOISE EMISSION

The airborne noise produced by the machine produces an A-weighted continuous sound pressure level of less than 70 dB.

8. ELECTRICAL CONNECTION



ATTENTION!

The electrical connection must be made by professionally qualified personnel and must meet the requirements of current local and national rules and/or regulations. Check that the supply voltage corresponds to that indicated on the nameplate data (voltage tolerance $\pm 10\%$, frequency tolerance $\pm 1\text{Hz}$).



ATTENTION!

Check that the supply voltage corresponds to that indicated on the nameplate.

The nameplate data is visible on the rear of the machine. For the connection, use a cable of type H05 VV – F or higher, dimensioned according to the data on the plate. Upstream of the appliance, place an omnipolar disconnection device interlocked with a padlock (e.g. a residual current circuit breaker) with an opening between the contacts that allows complete disconnection under the conditions of overvoltage category III, and in compliance with the relevant regulations in force.

The breaking capacity of the circuit breaker must be at least 10 kA.



ATTENTION!

Provide electrical protection by means of a type B RCD interrupting device (sensitive to the average current value).

Make sure that the main switch of the system is in the "0" (OFF) position when connecting the machine. Make sure the main switch of the machine is in the "0" position. Open the inlet door for the power supply. Feed the suitably sized power cable (see tables below) through the cable gland supplied with the machine. The connection of the electrical supply cables must be made to a disconnect switch and earth terminal (already present in the appliance).

Depending on the type of power supply provided by the machine's rating plate, connect the wires, with the help of the tip of a screwdriver, to the disconnecter and to the earth terminal marked as follows:



: Ground Clamp

L1, L2, L3: Phase connections

N: Neutral connection

When installing or replacing the power cable, the earth conductor must be at least 5 cm longer than the others.

**ATTENTION!**

The appliance must be connected to an effective earthing system: the manufacturer declines all responsibility in the event that this connection is not made in accordance with the provisions of the regulations in force on the subject. If the washing machine is installed on a metal surface, that surface must be connected to the earthing system with a conductor independent of the washing machine's grounding.

**ATTENTION!**

For tilting machines, make sure that the movement of the machine does not compromise the connection to the electrical supply panels.

**ATTENTION!**

For machines equipped with a servo-ventilated motor, make sure that the direction of rotation of the fan agrees with the direction printed on the motor label. If there is a discrepancy, reverse the order in which the phases are connected directly from the main terminal block of the machine.

Before any maintenance operation, disconnect the power supply: for maintenance, refer to the wiring diagram of the machine, inserted in the left side door or available on the manufacturer's website.

The minimum cross-sections for the power and ground cables, expressed in mm², are as follows:

mm ²		ELECTRIC OR ELECTRIC HEATING + STEAM (50/60Hz)		
TYPE	SIZE	1ph208V-240V	3ph208V-240V	3ph380V-440V
R, S	8	6	4	4
R, S	11, 14	10	6	4
R	18	16	10	6
S, D	18	NA	10	6
R	23	16	10	6
S, D	23	NA	10	6
S	26	NA	16	10
R	30	NA	16	10
D	30	NA	16	10
S	32	NA	16	10
R, S	40	NA	25	10
R, S, D	55, 70, 85	NA	25	16
S	100, 125	NA	NA	NA

mm ²		STEAM OR HOT WATER HEATING (50/60Hz)		
TYPE	SIZE	1ph208V-240V	3ph208V-240V	3ph380V-440V
S	8, 11, 14, 18	2,5	2,5	2,5
R	11, 14, 18	2,5	NA	2,5
S, D	18	NA	2,5	2,5
R	23	2,5	NA	2,5
S, D	23	NA	2,5	2,5
S	26	NA	4	4

mm ²		STEAM OR HOT WATER HEATING (50/60Hz)		
TYPE	SIZE	1ph208V-240V	3ph208V-240V	3ph380V-440V
R	30	NA	4	4
D	30	NA	4	4
S	32	NA	4	4
R	40	NA	4	4
S	40	NA	6	6
R, S, D	55	NA	6	6
R, S	70, 85	NA	10	6
S	100, 125	NA	10	6

TYPE: R= rigid, S= supercentrifugal, D= aseptic

SIZE: load capacity expressed in kg

NA: Not applicable



ATTENTION!

The minimum sections mentioned above may vary depending on the length of the connection. For lengths greater than 5 meters, increase the section proportionally to the additional length.



ATTENTION!

The connection of the machine must always be carried out according to the serial data (power, supply voltage, frequency). For supply voltages other than those provided, ask the manufacturer for information.



ATTENTION!

In the event that the power supply comes from a diesel generator, the inverter requires the application of an additional inductance and a special filter.



ATTENTION!

In the event that the machine runs on coins, tokens or equivalent systems, the emergency stop device is not present. The installer must provide and install an emergency stop device located remotely and connected to each machine in the installation.



ATTENTION!

The minimum sections shown may vary depending on the length of the connection. For lengths greater than 5 meters, increase the section proportionally to the additional length.



ATTENTION!

Even when the position of the main switch is "0", the cables upstream of the switch are live!



ATTENTION!

The connection of the machine must always be carried out according to the serial data (power, supply voltage, frequency). For supply voltages other than those provided, ask the manufacturer for information.



ATTENTION!

All washing machines are equipped with speed regulation and therefore equipped with a frequency variator: it is specifically necessary to provide differential protection by means of an RCD device of type B (sensitive to the average current value).

**ATTENTION!**

The machinery must be protected by suitable circuit breakers of the magnetothermic and differential type, installed outside the machinery. The breaking capacity of the circuit breaker must be at least 10kA. Magnetic protection, i.e. protection against short circuits, can alternatively be carried out by means of an omnipolar fuse disconnector of the same size.

The characteristics of the capacity of the circuit breaker, as well as the current IDn of the differential, are listed in the following table:

		ELECTRIC OR ELECTRIC HEATING + STEAM (50/60Hz)		
TYPE	SIZE	1ph208V-240V	3ph208V-240V	3ph380V-440V
R, S	8	32A - 0.03A	20A - 0.03A	16A - 0.03A
R, S	11	63A - 0.03A	25A - 0.03A	16A - 0.03A
R	14	80A - 0.03A	32A - 0.03A	20A - 0.03A
S	14	NA	40A - 0.03A	20A - 0.03A
R	18	100A - 0.03A	40A - 0.03A	25A - 0.03A
S, D	18	NA	40A - 0.03A	25A - 0.03A
R	23	100A - 0.03A	63A - 0.03A	32A - 0.03A
S, D	23	NA	40A - 0.03A	25A - 0.03A
S	26	NA	80A - 0.03A	40A - 0.03A
R	30	NA	80A - 0.03A	63A - 0.03A
D	30	NA	80A - 0.03A	63A - 0.03A
S	32	NA	80A - 0.03A	63A - 0.03A
R, S	40	NA	100A - 0.03A	63A - 0.03A
R, S, D	55, 70, 85	NA	125A - 0.03A	63A - 0.03A
S	100, 125	NA	NA	NA

		STEAM OR HOT WATER HEATING (50/60Hz)		
TYPE	SIZE	1ph208V-240V	3ph208V-240V	3ph380V-440V
S	8	6A - 0.03A	NA	6A - 0.03A
R, S	11	6A - 0.03A	NA	6A - 0.03A
R	14	6A - 0.03A	NA	6A - 0.03A
S	14	NA	6A - 0.03A	6A - 0.03A
R	18	6A - 0.03A	NA	6A - 0.03A
S, D	18	NA	10A - 0.03A	10A - 0.03A
R	23	6A - 0.03A	NA	6A - 0.03A
S, D	23	NA	10A - 0.03A	10A - 0.03A
S	26	NA	16A - 0.03A	10A - 0.03A
R	30	NA	20A - 0.03A	16A - 0.03A
D	30	NA	20A - 0.03A	16A - 0.03A
S	32	NA	20A - 0.03A	16A - 0.03A
R, S	40	NA	25A - 0.03A	16A - 0.03A
R	55	NA	25A - 0.03A	16A - 0.03A
S, D	55	NA	32A - 0.03A	20A - 0.03A
R, S	70	NA	32A - 0.03A	20A - 0.03A
R, S	85	NA	40A - 0.03A	25A - 0.03A
S	100, 125	NA	4A - 0.03A	25A - 0.03A

TYPE: R= rigid, S= supercentrifugal, D= aseptic

SIZE: load capacity expressed in kg

NA: Not applicable

9. HYDRAULIC CONNECTION: WATER LOADING

The washing machines are equipped with solenoid valves for loading cold and hot water (and hard water for

models that provide it): each water inlet is identified: for the connection dimensions, refer to the relevant technical data sheet.

A gate valve must be provided upstream of each hydraulic supply pipe that allows the flow of water to the machine to be interrupted at any time, both for any emergency situations and for normal maintenance operations. An inspectable water filter must be installed upstream of each inlet: it is also a good idea to check the filters of the loading solenoid valves, after a short period of use of the machine, especially if the pipes to which the connection has been made are old or have not been used for a long time.



ATTENTION!

The water supply pressure must be between a minimum of 0.05 MPa and a maximum of 1 MPa. The water inlet temperature should never be below 5°C and above 60°C.

(The minimum and maximum values take into account all the different models of valves present in the different sizes of machinery).

The lower the supply pressure, the higher the load times.

In the presence of several washing machines, the water supply line must have a diameter that allows a rapid flow even in the case of simultaneous loading of all washing machines.



ATTENTION!

All water inlet valves must be connected at all times! If the system does not have hot water served, use cold water to also supply the valve identified as "HOT WATER" and, where present, also the one identified as "HARD WATER".



ATTENTION!

For tilting machines, make sure that the movement of the machine does not compromise the connection to the water inlet manifolds.



ATTENTION!

The HOT WATER heating system does not provide any other independent or external forms of heating other than the same hot water served to the machine. However, thermoregulation is guaranteed by the alternating activation of the hot and cold water inlet.

10. PLUMBING CONNECTION: WATER DRAIN

The solenoid valves used for draining are of the normally open type, i.e. they drain the water in the event of a sudden power failure.

In the presence of several washing machines, the drain line must have a diameter such as to allow a rapid outflow of the simultaneous drains of all the washing machines; The drain manifold must be made in such a way as to make it impossible for water discharged from a washing machine to re-enter an adjacent washing machine.

The discharge is by natural fall, therefore the discharge pipes must not have depressions and counter-slopes: a minimum slope of 2% is required for correct outflow.

The exhaust system must meet the requirements of applicable local and national standards and/or regulations.



ATTENTION!

For tilting machines, make sure that the movement of the machine does not compromise the connection to the drain sump.

11. STEAM CONNECTION

Only for machines equipped with steam heating, it is necessary to make a connection to the steam network. The connection must be made by professionally qualified personnel and must meet the requirements of current local and national rules and/or regulations. Check that the steam has the characteristics indicated in the technical data sheets, and that all system components are certified.

The steam valve is delivered unassembled: its electrical and hydraulic connection is the responsibility of the installer.



ATTENTION!

Once the connection of the valve to the outside of the machine has been completed, the assembly must be protected by the metal box supplied: see figure below.

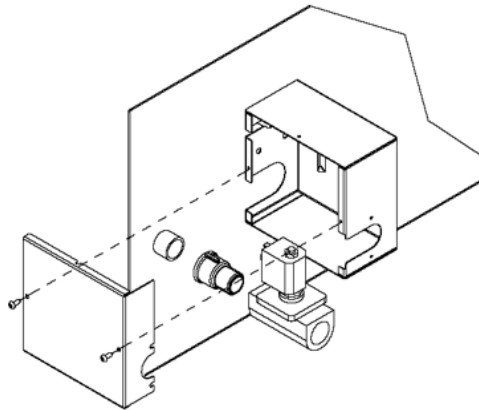

The steam supply system must be built according to the following scheme. Finally, all the connections between the system and the appliance must be subjected to a leak test.

- A) machine
- B) Outdoor system
- C) Steam supply system

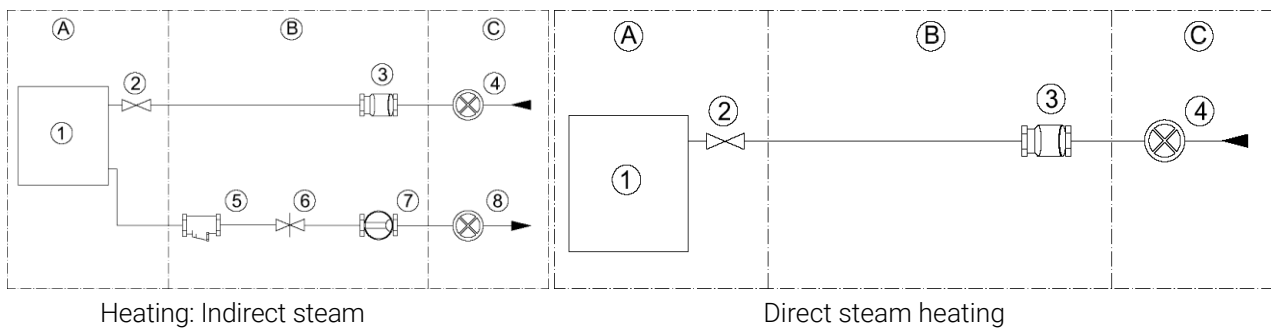

The elements of the system are identified in the diagrams as follows:

- 1) washing machine
- 2) steam valve (supplied)
- 3) filter
- 4) Steam inlet gate valve
- 5) Steam trap
- 6) Non-return valve
- 7) Passage indicator
- 8) condensate outlet gate valve



ATTENTION!

The machine can operate with a steam pressure of 0.5bar to 9bar, but the lower the steam pressure, the longer the water is heated during the washing phases.



ATTENTION!

For tilting machines, make sure that the movement of the machine does not compromise the connection to the steam manifolds.

12. COMPRESSED AIR CONNECTION

The connection to the compressed air system is only necessary for certain machine models: please refer to the data sheet.

The system must be carried out by professionally qualified personnel and must meet the requirements of current local and national standards and/or regulations.

All connections between the system and the device must be subjected to a leak test. For this operation, we recommend the use of grout sprays. If there are leaks, remove them



ATTENTION!

For tilting machines, make sure that the movement of the machine does not compromise the connection to the air system.

13. INTERNET CONNECTION

For machines that are equipped with it, there is a device on the backrest that can connect to the internet (IOT, Internet Of Things).

With the IOT system installed and working, together with the use of the appropriate portal, it is possible to keep your machinery up to date, send and receive customized configurations, modify/create washing programs remotely without going to the user, detail the graphic aspect of the touch screen, receive operating statistics and the report of errors/malfunctions.

The connection to the network can be made via cable (ETHERNET) or via WIFI connection (2.4 GHz).



ATTENTION!

Make sure that you have obtained permissions from your local network administrator. Check for any blocks or firewalls that prevent new devices from taking advantage of the local internet. Check that the WIFI coverage (2.4 GHz) is constant and present at the location where the machinery is installed. If you prefer to use via ETHERNET cable, be sure to perform all continuity and connectivity checks to the main router/modem before connecting it to the machine.

Using the user password 1234567, enter the PASSWORD AND INITIALIZATIONS menu and then IOT NETWORK CONFIGURATION.

If the connection is made via cable, select ETHERNET, press the box with three dots and set the DHCP configuration to OFF if you need to set a well-defined IP for the machine, otherwise leave DHCP on for automatic assignment (recommended).



If the connection is made via WIFI (2.4 GHz) select WIFI, press the box with three dots below, press the magnifying glass icon to scan for available networks (SSID), if necessary enter the network password (ask the network administrator).

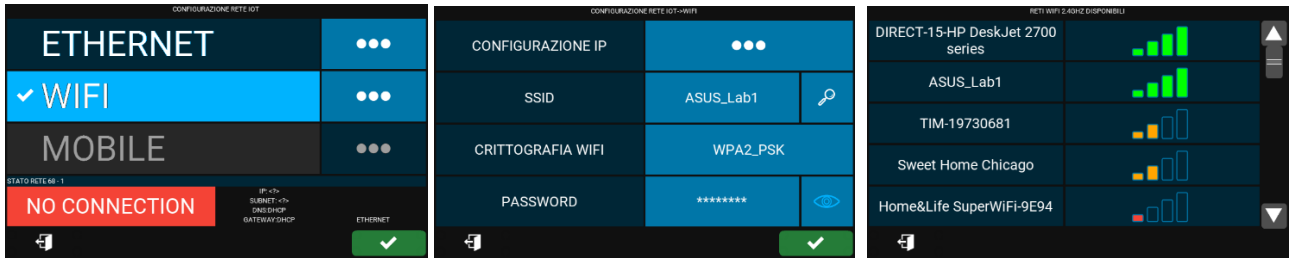

For both connection modes, the actual connection status is immediately evidenced by the messages:

- NO CONNECTION: The network does not reach the machinery, The network has not been set up correctly, the IOT device of the machinery is turned off.
- WAITING CLOUD REPLY → NO CLOUD: The network has been configured but the coverage is not sufficient, the cloud does not recognize the machine.
- OK: The connection has been established and is solid.

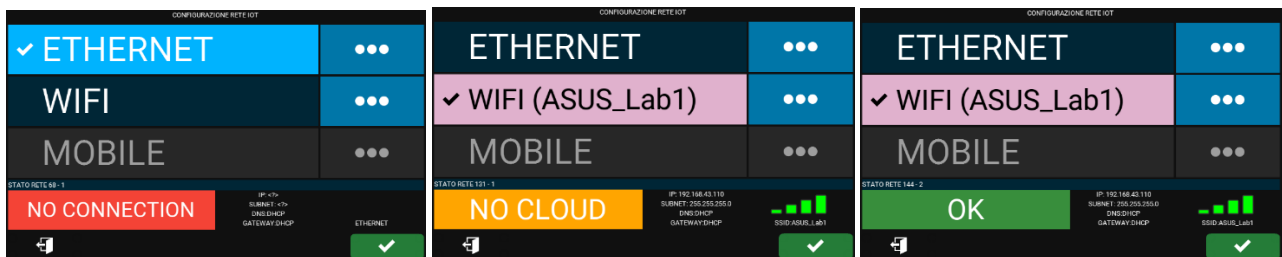

The connection status of the machine is also shown on the main program selection screen. At the bottom left of the display, the white cloud with exclamation mark shows a generic connection error, while the green cloud guarantees perfect connectivity of the machine.

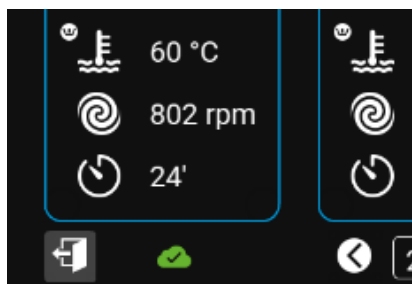

When the machine is connected to the network, the system update is performed automatically every 12 hours: the machine can therefore perform two synchronizations a day without any intervention, it will only be necessary to keep it on. The automatic update takes place even when the machine is running and does not limit its use. Conversely, you can perform multiple synchronizations by operating manually. Log in with the password 1234567, select MAINTENANCE and then IOT UPDATE. Then press the green triangle icon to download/upload updates to and from the cloud. During the manual update phase, the machine is not operational and the screens that appear are like those described below.

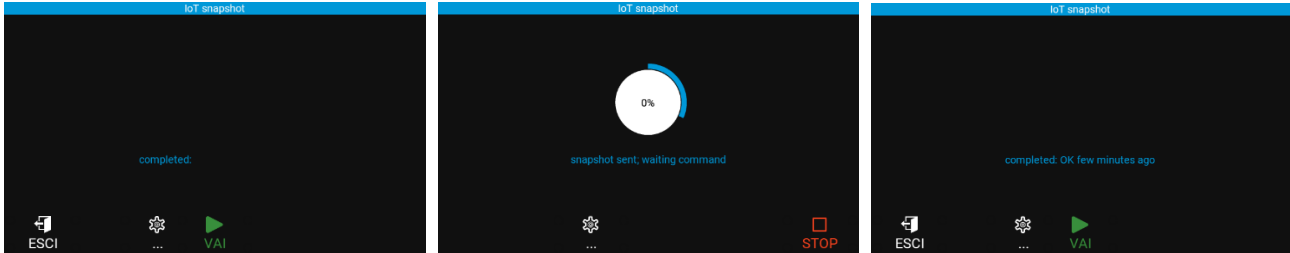

If the downloaded modifications or updates require it, the machine may switch off and on again autonomously (re-boot) at the first useful pause, i.e. when a wash cycle is not in progress. The re-boot is pre-signaled on the display and the user has the right to postpone it to the next useful break.

14. USE OF DETERGENTS

The user should contact their chemical supplier to be aware of the risks associated with individual products and their combinations.

You will need to have assurances that the products and their combinations are compatible and do not cause oxidation or harm to people and the washing machine.

In this regard, the following are the elements that come into contact with detergents:

- stainless steel AISI304;
- polypropylene PP;
- EPDM, NBR, silicone rubbers;
- borosilicate glass.



ATTENTION!

Attention is drawn to the fact that the use of hypochlorite (bleach) generates corrosion that can cause defects on some parts of the machine, under certain conditions of use.

15. MACHINE START-UP AND TESTING, USER PASSWORD

Once all connections have been made, the machine must be started in accordance with the instructions provided for by its control equipment. The machine must be tested in all its parts: it is particularly suggested to attend at least a complete program, carried out with a full load.

When you turn it on for the first time, you will be asked to select the language, date and time. However, these items can be modified at a later time by pressing the MENU button and entering the password "USER": 1234567. In addition, every time it is switched on (for machines that are equipped with it), it will be possible to connect the machine to a WIFI or wired internet network. By pressing the green button, you can access the configuration menu of your network. The message disappears once the connection is made or in any case after pressing the red button to cancel the request.

16. THE EMERGENCY BUTTON

The image below shows the emergency mushroom (if present).



ATTENTION!

The emergency button (if present), when pressed, acts in stop mode category = 1: cutting off the power supply to the control. In this case, the display turns off and the cycle is automatically interrupted: the basket, if it has

been rotating, stops inertially; The tub is emptied.

The emergency mushroom should only be pressed in case you are faced with a dangerous situation.

When the dangerous situation is overcome, the emergency button can be reset, turning it clockwise: the display lights up and any previously interrupted cycle remains in standby mode and the following possibilities are provided:

- resume the previous program from the cycle that was interrupted;
- abort the program permanently.



ATTENTION!

It is important that the Laundry Manager is aware of the emergency procedures and that he or she ensures that the personnel who will be using the machine are aware of the dangers of the machine itself and are familiar with the emergency procedures themselves.

Periodic tests are performed on personnel operating the machine to ensure that the procedures have been properly understood.

17. THE DETERGENT DRAWER

The image below shows the access door for loading detergents.

In smaller machines, the opening of the rubber lid highlights three compartments P, W, S for loading detergents respectively for pre-wash, wash and fabric softener.

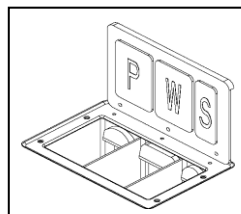

On larger machines, the opening of the metal door highlights 4 carafes for loading powder or liquid detergents. Please note that the detergent loading times and the activation durations of the corresponding valves are programmable.

18. AIR VENTS

The air openings in the backrest and possibly on the lid of the machine, including the vent fittings, must always remain free (example). The passage of air through the louvers must not be restricted in any way!



19. PREPARE YOUR GARMENTS

The machine must be loaded according to the characteristics on the serial label: it must not be loaded with a weight greater than the nominal load provided for in the technical data sheet and the serial plate.

Before deciding on the most appropriate programme, divide the laundry according to the fabrics and fibres, in order to achieve an even washing of the entire load.

Before loading, make sure that the garments bear the label with the authorization to wash in the machine and always follow the instructions of the fabric manufacturer.

20. USE OF THE ASEPTIC MACHINE

The Aseptic washing machine is designed for use in environments where it is crucial to maintain a high level of hygiene, such as hospitals, laboratories, and food industries. Its main purpose is to prevent cross-contamination between dirty and clean laundry. This type of washing machine is characterized by a structure with two distinct compartments: a "dirty side", where contaminated laundry is loaded, and a "clean side", where laundry is drained after the washing and sanitizing cycle. The physical separation between the dirty and clean sides prevents cross-contamination.

Load (Dirty Side): The dirty side operator loads the contaminated laundry into the washer through the hatch located on this side. The "dirty side" room should be designed to contain and handle dirty laundry, minimizing the risk of contaminants escaping into the air or other surfaces. The operator selects the appropriate wash cycle on IM11 (see next paragraphs). The cycles include several stages of pre-washing, washing, rinsing and disinfection, with the use of detergents that ensure the elimination of contaminants. The "dirty side" operator must wear personal protective equipment such as gloves, masks, and gowns to protect themselves from potentially hazardous contaminants.

Drain (Clean Side): Once the cycle is complete, the washed laundry is drained from the clean side of the machine. The hatch on this side can only be opened when the wash cycle is finished, ensuring that no contaminated laundry can come out of the clean side (see next paragraphs). The Clean Side Operator collects clean and sanitized laundry. This operator works in a controlled and hygienic environment, physically separated from the dirty side area to avoid any risk of recontamination.

21. LOAD THE MACHINE AND CLOSE THE DOOR

The machine must be loaded according to the characteristics indicated on the serial label. The label is glued to the back of the machine itself.



ATTENTION!

The machine must be loaded with linen that is as homogeneous as possible and with a weight that does not

exceed that provided for in the technical data sheet and serial label.

Before loading with dry laundry, make sure the drum is completely empty. After loading the machine, close the door.

Depending on the type of machine, the door can be closed in different ways:

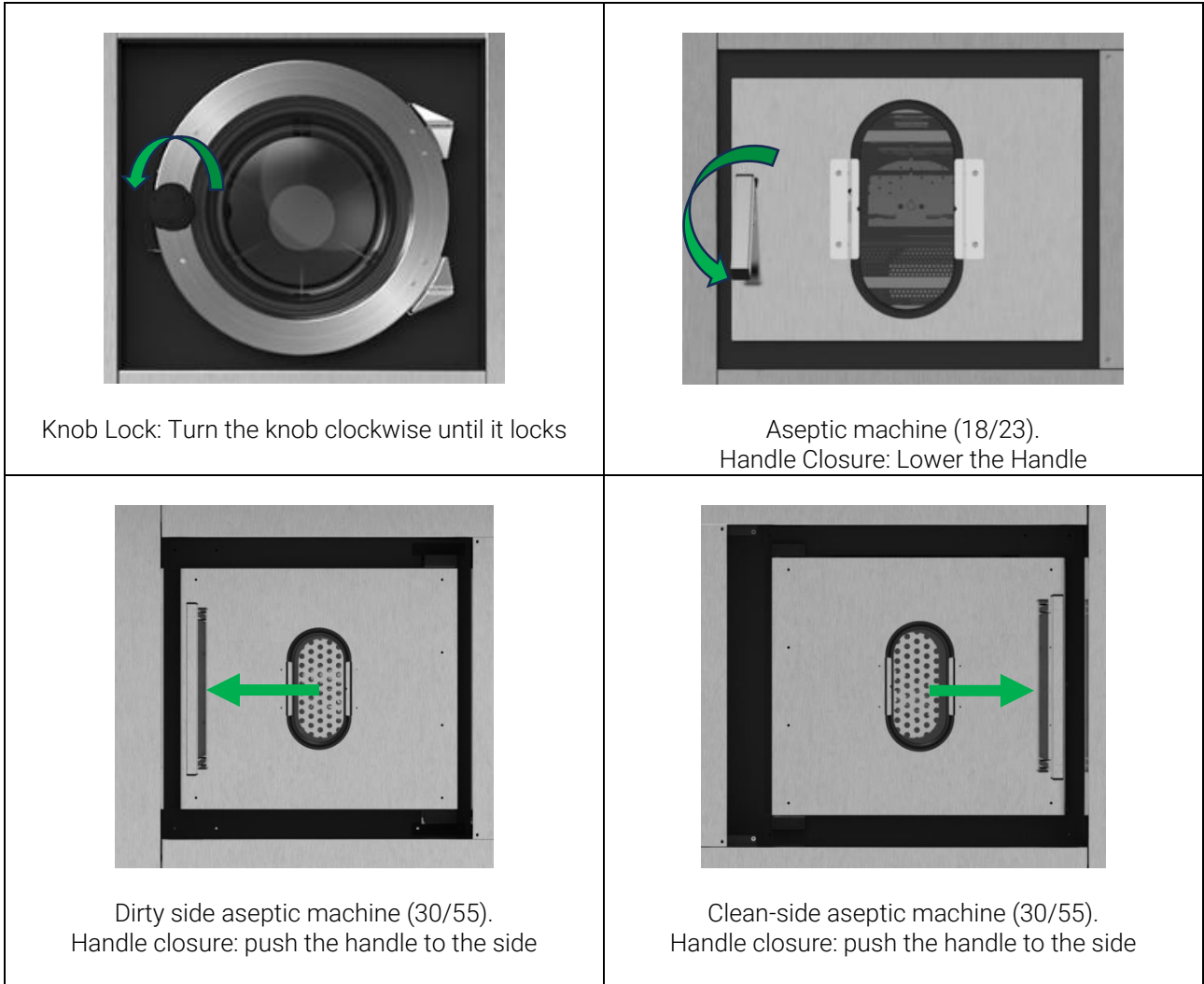

ATTENTION!

Make sure that when closing the door, no flaps of fabric are pinched between the door and the front of the machine.



ATTENTION!

For barrier washing machines (double door): before closing the external door, make sure that the internal door has been closed correctly, as follows:

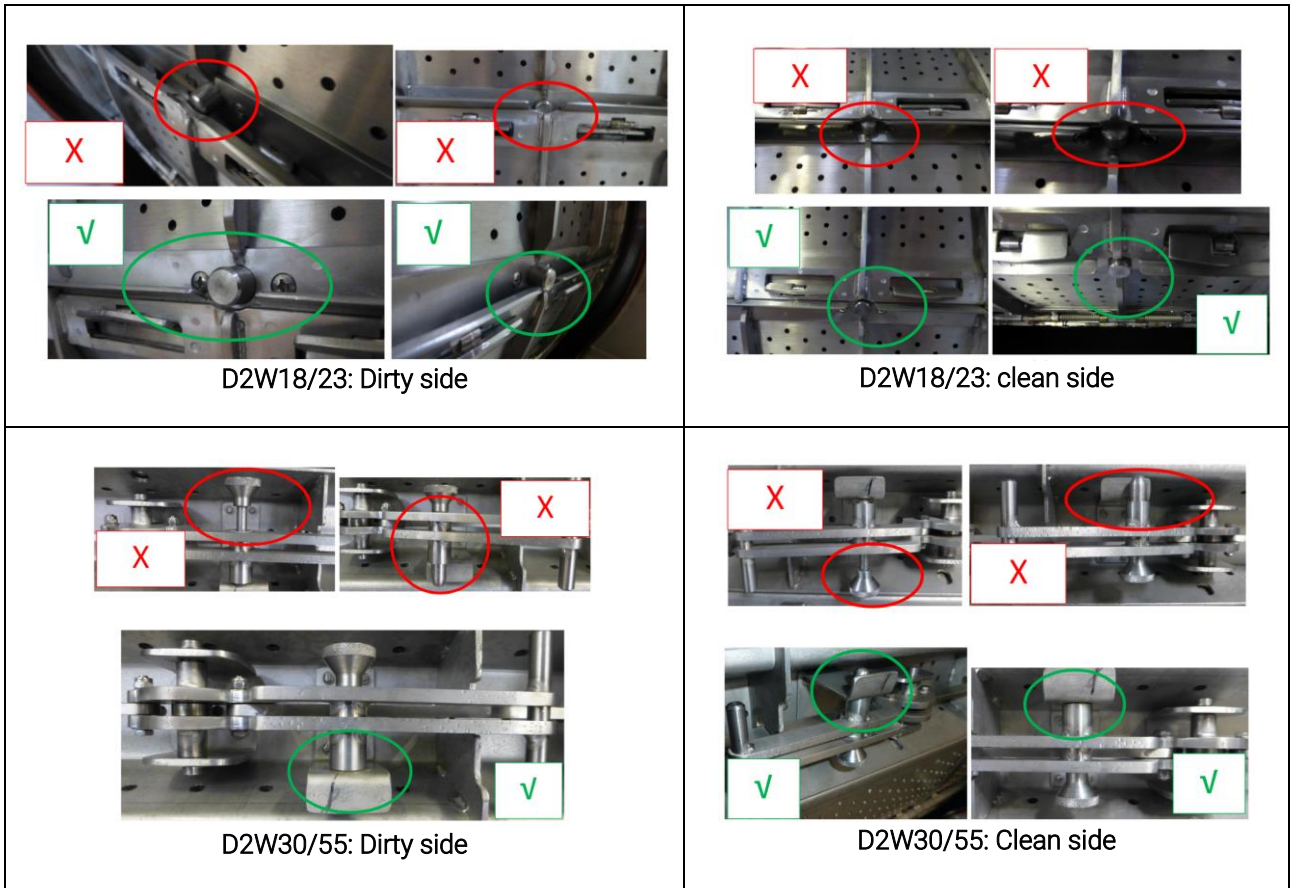

ATTENTION!

If the interior door is incorrectly closed, the cycle **MUST NOT** be started.
 Make sure that the operators have understood the instructions on closing the internal door on the machine!

22. MANUAL OPENING OF THE DOOR AND ENGINE UNLOCK'

During the cycle, it may be necessary to open the door manually, without the aid of keypad unlocking. The same procedure may be necessary in the event of a power failure:



ATTENTION!

Before performing the manual procedure, disconnect the electrical supply at the main switch.



ATTENTION!

The manual release of the door lock should **NEVER** be used during normal operation of the machine!

On standard machines, open the lower front panel. To release the door, pull the rope with a visible loop on the side. At the same time, turn the handle clockwise and open the door:

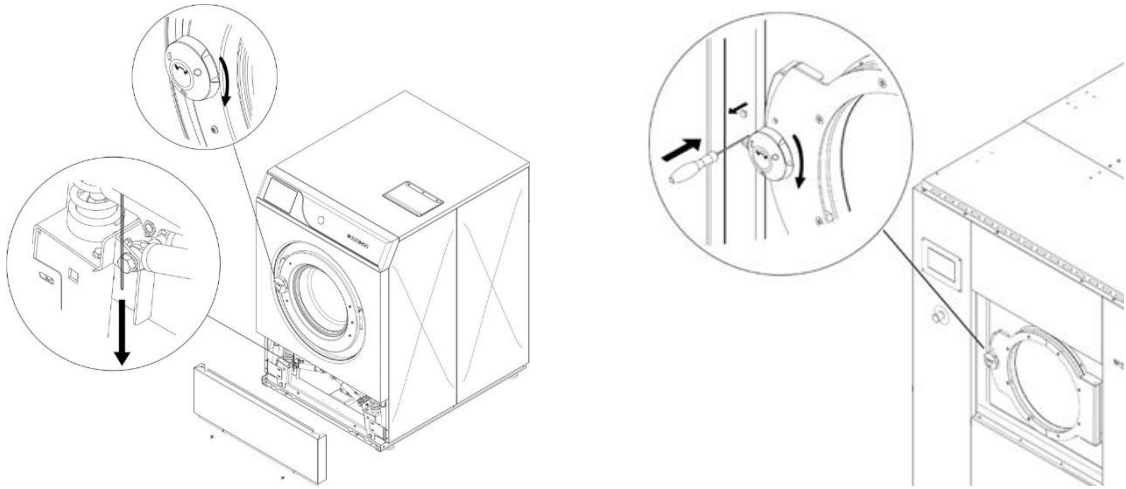

On the other hand, some standard washing machine models (the larger ones) have a small plastic cap just above the black rotary handle for opening the door. Remove the cap; Insert a slotted screwdriver into the hole: push the screwdriver all the way in and turn the handle clockwise at the same time.

On the other hand, even larger washing machine models are equipped with a pneumatic closing system: in this case, open the panel of the pneumatic system. Identify the adjustment screw of the solenoid valve "AP" (door opener). Using a flat screwdriver, turn the adjustment screw 90° clockwise. Wait a few seconds, then turn counterclockwise again, returning the screw to its original position.

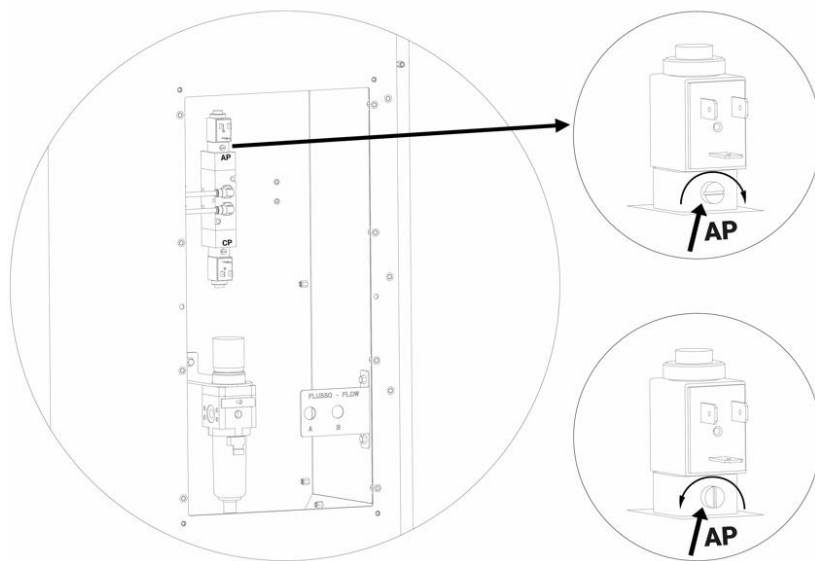

Finally, for aseptic machines, equipped with a double door (one for the dirty side, and one for the clean side) disassemble the lower (for 18/23kg machine) or side (for 30/55kg machine) access panels; To release the door, pull the rope with a visible loop on the side and then lift the opening handle:

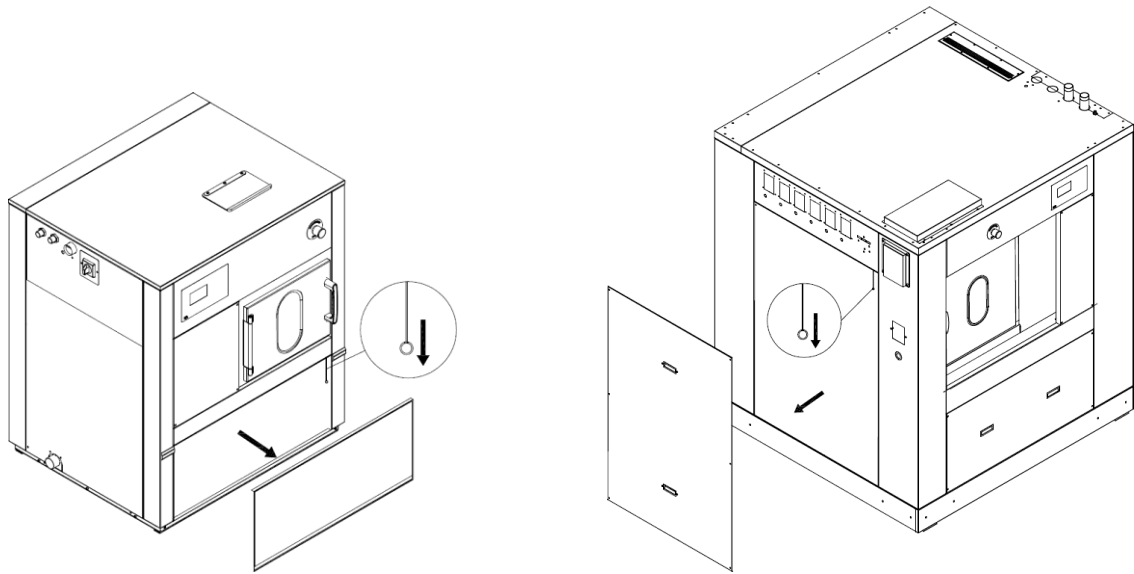

In the specific application of aseptic machines, it should be remembered that the basket motor is equipped with an electromagnetic brake, which is released during the execution of the cycle. When the machine is stopped or switched off, the electromagnetic brake is locked. If you need to rotate the basket in the absence of power supply, you can unlock the brake by turning a lever coming out of the motor cap.

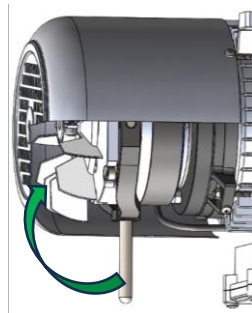

ATTENTION!

This can only be done by competent technical personnel!

IMPORTANT SAFEGUARDS



CRUSHING HAZARD

Before performing the manual procedure, disconnect the electrical supply at the main switch. When the brake is manually released, the drum immediately starts to rotate autonomously according to the weight of the laundry inside the drum!

Do not approach places where there is a risk of crushing, i.e. the areas of pulleys and drive belts!

23. TURNING ON THE MACHINE

Turn on the main switch that powers the machine.

For machines equipped with steam heating: open the gate valve to allow steam to enter. To limit water hammer,

perform the opening operation slowly: from the closed position to the open position, over a period of 1 minute. Make sure that the emergency button (for models that have it) is in the rest position and that it has not been activated.

Before starting the machine, always carry out the safety check procedure (check the relevant paragraph).

When you turn on the machine, the display shows the installed software version for a few moments.

Please note that it may take about a minute for the software to load.

The following screen appears on the display, followed by a series of slides that make up the screensaver.

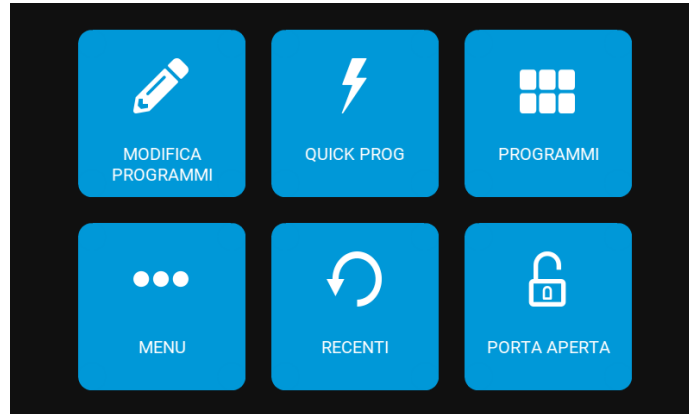

Load the washing machine as described in the relevant paragraph and close the door according to the procedure provided.

24. SELECTING A PROGRAM

After loading the machine and closing the door, the main screen appears on the display.

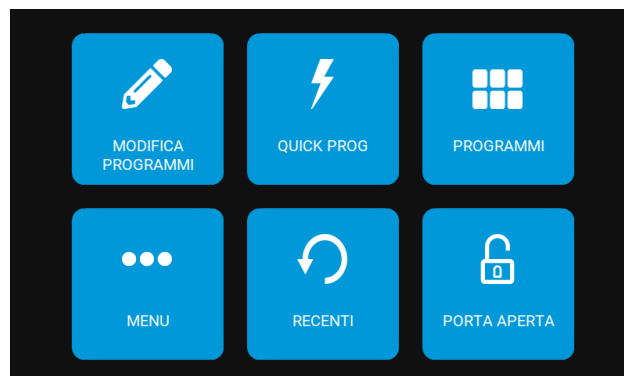

By tapping on the "PROGRAMS" icon, you can view the list of programs residing in your computer's memory. The following screen will appear on the display:

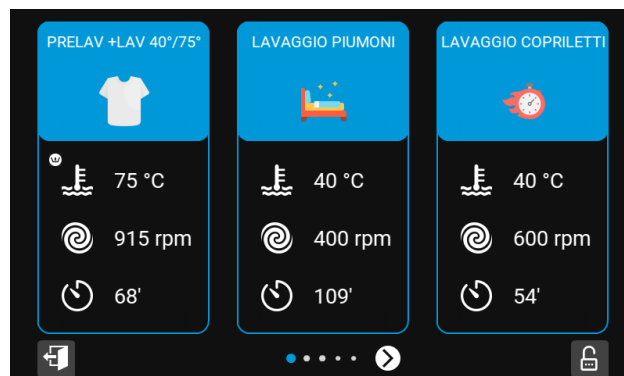

You can scroll through the list of programs using the arrows at the bottom of the screen. When the program you want is displayed, simply tap on it to highlight it.

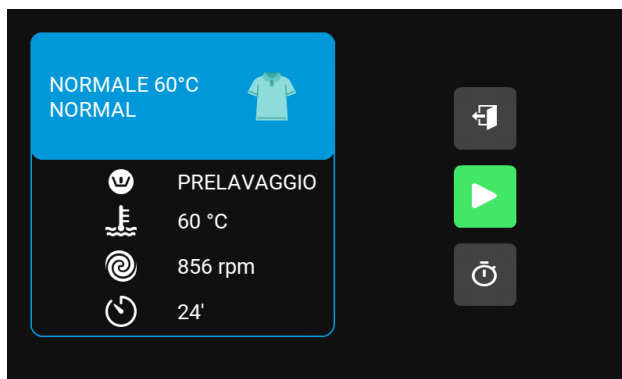



By tapping the icon , the selection is confirmed and if the door is closed correctly the program will be launched.

25. RECENT PROGRAMS

From the main menu, tapping on the "RECENT" icon will take you to the list of the most recently run programs. The selection and departure of the program takes place as described above.

26. DELAYED START

If you want to start a program with a delay, proceed to the selection as described above. Instead of tapping the icon  for immediate start, tap the  icon. The following screen appears on the display:

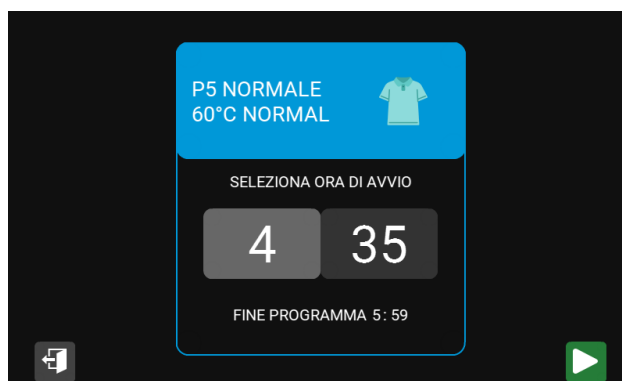

The start-up delay is set via the machine's internal clock and can be increased and decreased by clicking on the hours and minutes

The function can be abandoned by tapping the icon .

After configuring the desired delay, confirm the set data by tapping the icon . The following screen appears on the display:

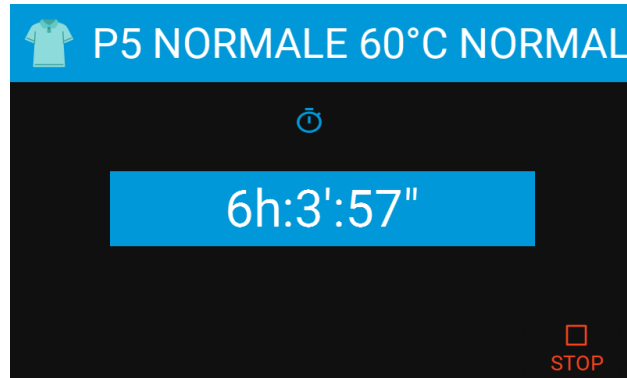

A countdown appears, indicating how many hours and minutes are left until the program starts automatically and late.

The countdown can be interrupted at any time by pressing the icon . When the countdown is up, the cycle will start automatically if the door is closed properly. The function allows the program to be postponed by up to 24 hours.

If, during the waiting period, for any reason, the machine is switched off, the timer will continue to run and the machine can be started at the chosen time, provided that the power supply has been restored in the meantime. In this case, you will still be asked for further confirmation of the start of the program. Equally, if the desired departure time coincides with the black-out period, the program will not be started, the "POWER FAILURE" message on the display will justify the non-execution.

27. EXECUTION OF A PROGRAM

After selecting the program, as described in the previous paragraphs, the cycle is started by pressing the icon



The selected program starts if the door is properly closed.

During the run, the following screen appears on the display:

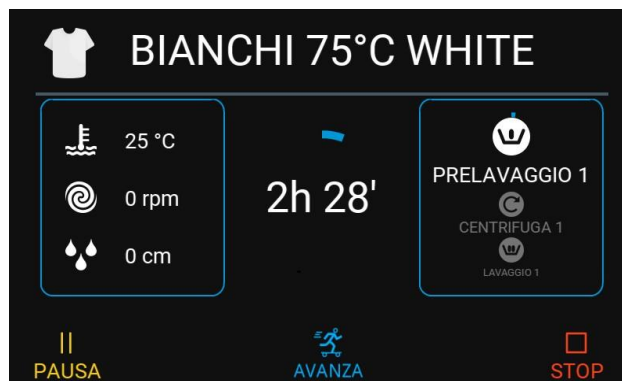

The information on the left of the display allows you to understand the operating conditions of the machine, while running the program.

All parameters can be changed on the run by simply tapping on the corresponding icon. These changes remain valid only for the current cycle: for updates on the function and for further information, please refer to the online documentation.



ATTENTION!

In the case of early termination of the cycle, remember that the temperature of the tissues may be high! In this case, the automatic opening of the door will not be permitted.



ATTENTION!

In the event of faults or malfunctions, switch off the equipment immediately and call an authorised service centre!

28. PAUSING A PROGRAM

While the program is in progress, you can pause it for a controlled pause.

To pause it, and then resume, simply press the  for a few seconds.

The following screen appears on the display, indicating the execution of a soak, the duration of which is highlighted in the center of the display.





The soaking can be stopped, and the cycle restarted, by pressing the icon . During soaking, the program can be completely stopped by pressing the icon .

29. FAST FORWARD

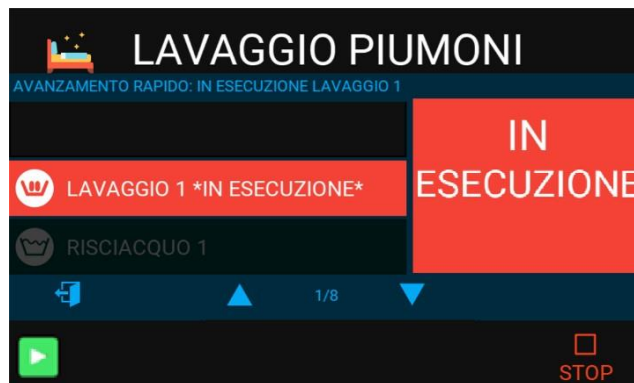
It is possible to move within the program by entering the quick move environment with the icon . The following screen appears on the display while the machine is momentarily on standby.



By pressing the "▼" and "▲→" , you can browse through the cycles of which the program is composed. By pressing the button , the selected cycle can be started. Pressing the button that depicts the door exits the screen without performing any advance action. The button  allows the program to be completely interrupted.

30. END OF EXECUTION OF A PROGRAM

At the end of the programme, open the door and unload the machine.

The machine will perform a check to verify that the door can be opened safely. When the three banners turn green, you will be able to open the door.

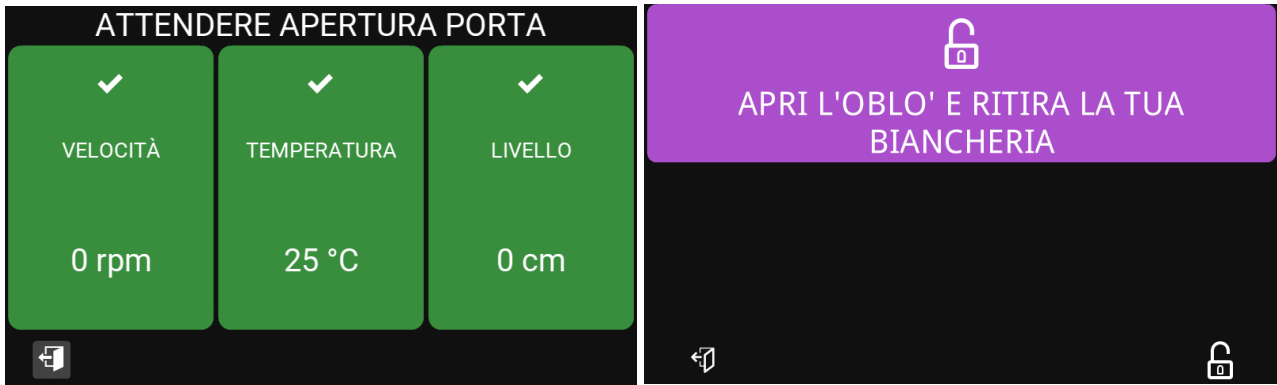

In the case of a door with a rotary handle, the following images will appear in sequence:

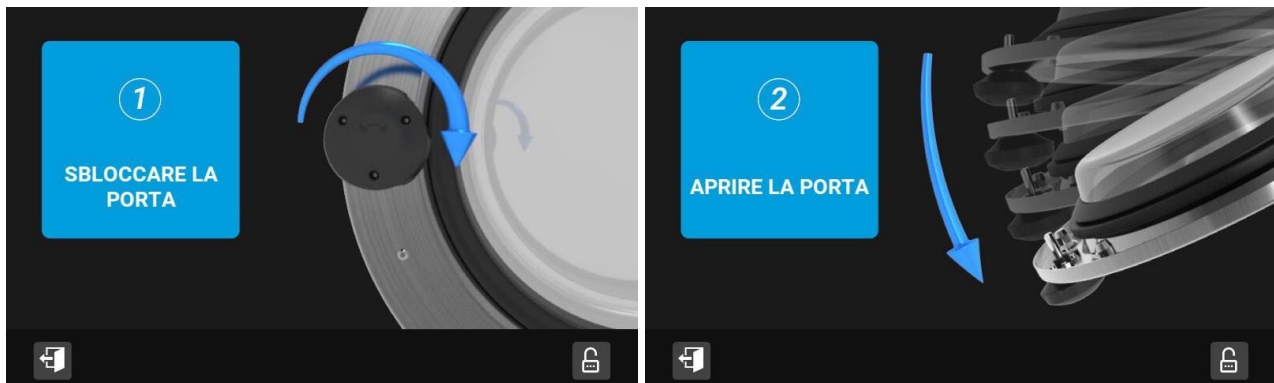

In the case of an aseptic machine, the unloading takes place by opening the door on the clean side. On the clean side there is a green door opening button and a red LED signal.

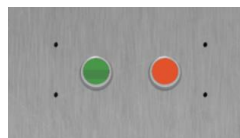

When the cycle is finished and the drum inside is in the unloading position, the green button lights up. To open the door, press the door handle. and, only after unlocking it, press the green button.



ATTENTION!

Before closing the external door, make sure that the internal door has been closed correctly, carefully following the instructions given in the previous paragraphs.

After closing the basket door correctly, close the outer door again. Make sure that the operators have understood the instructions regarding closing the interior door!

The red LED lights up only in the event of a malfunction (see the relevant paragraph). On the clean side there can also be a touch screen (optional) that indicates the countdown of the cycle during its execution. In this case, the buttons and information are shown on the display.

31. END OF WORKING DAY

At the end of the working day, the machine must be brought to the end of the cycle and switched off: the basket must be emptied and cleaned. Turn off all power supplies by operating the relevant line switches/disconnectors: electric, steam and compressed air. Finally, leave the door open.

32. PROGRAMMING

The programming procedure allows you to modify existing programs or create new programs. A program consists of a sequence of steps or steps, which can be configured in detail, in the various parameters that they are responsible for.
Use the instructions posted online.

33. COIN OP PROGRAMMING FOR SELF-SERVICE SYSTEMS

Two payment methods are available to manage the purchase of programs in a self-service environment: COIN ACCEPTOR for coins or tokens, CENTRALIZED CASH DESK to manage centralized payment systems or cashless devices. The purchase of a wash programme is intended for its entire duration.

The program selection screen presents the cost of each individual program and the amount of credit introduced.

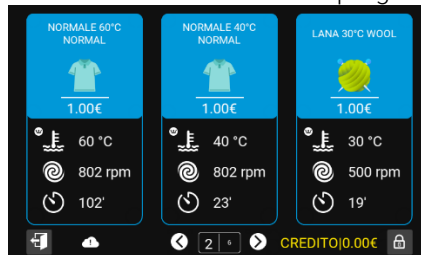

Only on machines configured with a CENTRALIZED CASH DESK payment system, the following screens also appear that identify the machine number to which the payment should be sent.

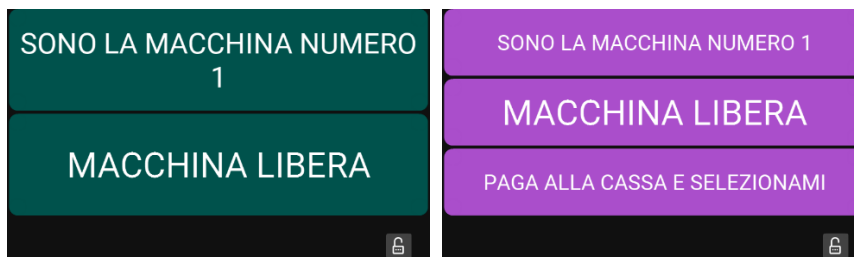

Selecting a program: if the credit introduced is less than the cost of the least expensive program, you will not be entitled to use the washing machine, the credit entered is highlighted in flashing yellow/red. If the credit entered equals or exceeds the cost of the selected program, the text will turn green and you will be able to start it. The machine will not provide the change on its own.

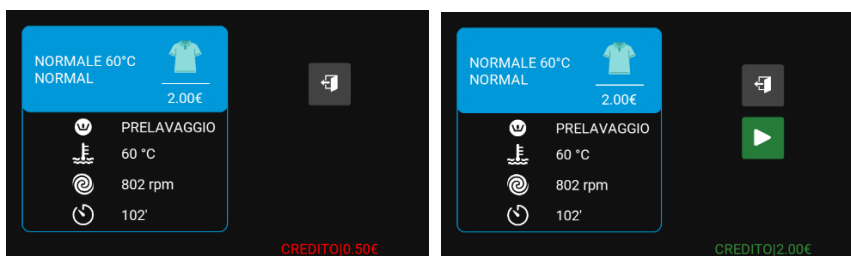

In COIN ACCEPTOR mode, the computer acts as a totalizer and allows the sum of several coin denominations or multiple tokens inserted in succession. It is possible to install alloy coin acceptors capable of accepting different denominations of coins, or electromechanical coin acceptors capable of validating only one type of coin or token. Once the coin or token has been inserted, a train of pulses or a single pulse (depending on the type of coin acceptor) comes from the coin acceptor that will be counted by IM11 and associated with a value (COIN1, COIN2 described below). It is possible to set programs with different prices from each other.

In CENTRALIZED CASH mode, payment is managed by an external system that provides an impulse to which a countervalue is associated (COIN1, COIN2 described below) generally equal to the cost of the most expensive

program. It is not possible to set programs with different prices from each other.

Although they are different methodologies, the criterion operated by the machine's computer for purchasing is the same: one or more pulses in sequence come from the COIN ACCEPTOR or from the CENTRALIZED CHECKOUT. Each pulse is associated with a credit unit, for example €0.10 or €5.00, IM11 counts the pulses and verifies whether the sum reached is equal to or greater than the cost of the desired program. When the credit introduced equals or exceeds the price of the most expensive program, the washing machine enters BUSY MACHINE mode until the end of the program execution and deactivates the coin acceptor or signals to the centralized payment system the unavailability to pay again on the same machine.

The parameters described below can only be modified by means of the access key to the technical menu, and the respective submenus: MACHINE CONFIGURATION→CHRISTENS→PAYMENT:

- TYPE OF PAYMENT SYSTEM: NONE / COINS-TOKENS / CENTRALIZED CASHIER.
- MACHINE NUMBER: This is the number assigned to the machine and is used only in the CENTRALIZED CASH REGISTER mode.
- CURRENCY TYPE: You can set one of the currencies already stored (€, \$, £...) or generate a custom currency.
- DECIMALS TO DISPLAY: Displays the decimal places of the chosen currency.
- COIN VALUE 1: This is the equivalent value associated with the payment channel coming from a validation system. This corresponds to input 1-2 of the CN22 connector on the IO board.
- COIN VALUE 2: This is the equivalent value associated with the second payment channel coming from a validation system. For example, the machine can accommodate a second coin acceptor. This corresponds to input 3-4 of the CN22 connector on the I/O board.
- MACHINE BUSY SIGNAL: When the machine has reached an amount equal to or greater than the price of the most expensive program, an IO card relay (terminals 1-2 of the CN28 connector of the IO card) switches its state from off to on or vice versa, at the discretion of the payment system present. It is used to signal that the machine is engaged as well as to inhibit the payment system to prevent overpayment
- CREDIT RESET TIME: Allows you to set a time, in minutes, within which the credit entered, if not yet used, is reset to zero.
- PROGRAM RESET TIME: Allows you to set a time, in minutes, within which you can interrupt it to select another one when the program has already started.
- ENABLE EMBEDDED COIN CONTROL: Enables or disables control over the status of COIN1 and COIN2 inputs. If the contact remains closed for too long, it is possible that a token has become stuck or that the pulse coming from the CENTRAL CASH REGISTER is too long
- STUCK COIN DURATION: Defines the time after which the STUCK COIN error is triggered.
- COIN INSERTION BEEP: Enables a beep for each payment pulse received on COIN1 or COIN2.

Access to the price configuration of each individual program is possible by means of a user password. In self-service mode, the menu can be accessed within 30 seconds after the machine is switched on. Simply press the



button from the main screen, then press the EDIT PROGRAMS button and type in the user password again. Click on the "DETAILS" cell of the respective row to change the price of the program.



In the user area there is also a credit management menu that contains the following functions:

- CREDIT: Describes the total credit introduced into the machine. It also takes into account any excess money that was not used to purchase programs.
- CREDIT USED BY PROGRAMS: Detail the total credit actually used to start the programs.
- CREDIT PER PROGRAM: Detail the credit accrued for each program.

- CREDIT TIMED OUT: This is credit that has not been used within the time set by the CREDIT RESET TIME parameter described above.
- RESET CREDIT STATS: allows you to reset the stats described in this menu.
- CREDIT RESET: resets the credit in the car without waiting for the CREDIT RESET TIME to expire.

Some programming examples:

Example 1: Machine with electronic coin acceptor with alloy recognition for €:

- Coins accepted: 0.10€, 0.20€, 0.50€, 1.00€, 2.00€.
- Program cost: PROG1 = 5.00€; PROG2 = 4.00€; PROG3 = 3.00€.
- Coin acceptor set by the manufacturer in steps of 0.10€.

It is recommended to set the price of the programs as described above, below set COIN1 to 0.10€. Each coin introduced will be automatically "divided" into €0.10 sub-units, so a €2.00 coin will be sampled with 20 pulses. Each pulse will then be associated with the value of COIN1 equal to €0.10 and IM11 will be able to reconstruct the amount introduced.

Example 2: Machine with mechanical coin acceptor for the recognition of a token:

- Program cost: PROG1 = 5 TOKENS; PROG2 = 4 TOKENS; PROG3 = 3 TOKENS.
- Coin acceptor set by the manufacturer to provide 1 pulse with each token pass.

It is recommended to set the price of the programs as described above, below set COIN1 to 1 GET. Each token introduced will be valued with the amount described by COIN1 equal to 1GET; therefore, the purchase of PROG1 will require the insertion of 5 tokens, PROG2 the insertion of 4 tokens, PROG3 the insertion of 3 tokens.

Example 3: Machine with electronic coin acceptor to recognize the € and 1 type of token.

Electronic coin acceptors also allow you to accept coins of different currencies or tokens of different denominations; In the case described here, it is a matter of associating the token with the equivalent value of a specific coin among those accepted by the coin acceptor.

- Coins accepted: 0.10€, 0.20€, 0.50€, 1.00€, 2.00€.
- Coin value = €2.00
- Program cost: PROG1 = 5.00€; PROG2 = 4.00€; PROG3 = 3.00€.
- Coin acceptor set by the manufacturer in steps of 0.10€.

As described in example 1, it is a matter of programming the coin acceptor to associate the value of 1 token with €2.00. In this regard, consult the manual of your coin acceptor or the manufacturer as dedicated software may be required. Mixed payment will then be allowed and the purchase of a program can be made as follows: PROG1 = 2 GET + 1.00€, or 1 GET + 4.00€.

Example 4: Machine connected to a central cash register Selected machine: Washing machine n°1.

- Program cost: PROG1 = 5.00€; PROG2 = 5.00€; PROG3 = 5.00€.

Since there is only one signal from the centralized cash register to the machinery, the cost of the programs must be unique and linked to the equivalent value of COIN1. Therefore, set the value of COIN1 to €5.00, equal to the price of the programs. Select the machine number (1) on the control panel, go to the front of the machine to load the laundry and select the washing program. Compatibly with the configurations of the central payment center, machine no. 1 will be occupied at the end of the payment so as to prevent the next purchaser from accidentally paying to the machine already in use.

34. DISPLAY SIGNALS

The computer provides complete diagnostics both in the event of malfunctions and in the case of simple signals. Below is the list of signals that may appear on the display. In any case, the user is invited to contact an authorized service center to solve the problem.

COD	DESCRIPTION	WHAT TO DO
1	ENGINE THERMAL	The following appears on the display: "ALARM!! 01 Thermal Engine". The machine stops and the buzzer sounds for 15 seconds. When you touch the touch, the alarm is reset and the door opens. The motor has overheated – wait for the engine to cool down and restart the cycle. If the problem occurs frequently, call the Authorized Service Center.

COD	DESCRIPTION	WHAT TO DO
2	OPEN DOOR	The following appears on the display: "ALARM!! 02 Open Door". The machine stops and the buzzer sounds for 15 seconds. When you touch the touch, the alarm is reset and the door opens fully. The door opened while a cycle was in progress. Call the Authorized Service Center.
3	PROBE FAULT TEMPERATURE	The following appears on the display: "ALARM!! 03 Temperature Probe" (the temperature on the display changes to 237°C or 0°C) depending on the type of probe breakage). The cycle does not stop, but all heating steps are skipped. When you touch the touch, the signal is reset. A temperature probe has ruptured. Call the Authorized Service Center.
4	WDT LOADING	The following appears on the display: "ALARM!! 04 Load timeout". The machine stops and the buzzer sounds for 15 seconds. When you touch the touch, the alarm is reset and the door opens. The maximum time for loading water has been exceeded. Check that the inlet taps are open, that the inlet filters are clean, and that there are no water leaks. If the problem occurs frequently, call the Authorized Service Center.
5	WDT EXHAUST	The following appears on the display: "ALARM!! 05 Drain timeout". The machine stops and the buzzer sounds for 15 seconds. When you touch the touch, the alarm is reset and the door opens. The maximum time for draining water has been exceeded. Check that the drain line is properly cleaned. If the problem occurs frequently, call the Authorized Service Center.
6	EMBEDDED TOKEN	If a payment signal exceeds 6 seconds, the following appears on the display: "ALARM!! 06 Token blocked" The alarm remains until the payment system is unlocked. When the system unlocks, the standard screen returns.
7	SINGLE IMBALANCE	There was an imbalance in the basket during spinning. A rebalancing cycle is initiated to retry the centrifuge. The message appears on the display only after the second imbalance has occurred. A maximum of three consecutive imbalances are allowed in a single spin session. The message codes associated with this error are: 5.8.41, 5.8.42, 5.8.51, 5.8.52: single or double imbalance during an intermediate spin. 5.8.71, 5.8.72, 5.8.81, 5.8.82: single or double imbalance during a final spin.
8	TRIPLE IMBALANCE	Three consecutive imbalances have occurred during the same spin: the spin cycle is abandoned and the program automatically moves to the next cycle if the spin is intermediate, otherwise if it were the final spin it would be repeated to ensure the water extraction before removing the laundry from the drum. If the problem occurs frequently, make sure that the correct load mode (rated capacity, homogeneous load, integrity of the shock absorbers) is correct. The message codes associated with this error are: 5.8.43, 5.8.53: Triple imbalance during an intermediate spin, moves to the next cycle automatically. 5.8.73, 5.8.83: Triple imbalance during a final spin, will be repeated according to the settings in the machine.
	INVERTER LOCK	The following appears on the display: "ALARM!! 09 Inverter Lock". There is a problem with the inverter locking. The cycle continues but the basket does not turn: when the touch is touched, the signal is reset. NOTE: The message may be detailed with the inverter lock type. Call the Authorized Service Center.

COD	DESCRIPTION	WHAT TO DO
11	WDT HEATING	The following appears on the display: "ALARM!! 11 Warm-Up Timeout". The maximum time for water heating has been exceeded. The cycle does not stop, but all heating steps are skipped. When you touch the touch, the signal is reset. Call the Authorized Service Center.
12	CENTRIFUGE WATER	Although the machine has to increase the number of revolutions, the speed always remains fixed at 100rpm: this is not an alarm but the intervention of a safety device that occurs when the water level, during the spin start, does not fall below the expected level. Call the Authorized Service Center.
13	OVERHEATING	The following appears on the display: "ALARM!! 13 Overheating". The water temperature exceeded 110°C. The heating system is switched off and subsequent heating steps are skipped. Call the Authorized Service Center.
14	MAINTENANCE REQUEST	"Maintenance required" appears on the display. The machine has reached the number of cycles that require routine maintenance to be checked by the Authorized Service Center.
16	WDT DOOR LOCK	"WDT Door Lock" appears on the display. The maximum time for closing the motorized door has expired: call the Authorized Service Center.
17	WDT DOOR OPENING	"WDT Door Opening" appears on the display. The maximum time for opening the motorized door has expired: call the Authorized Service Center.
21 ...28	CANISTER 1 ... 8 SOLD OUT	The display shows "TANK 1 ... 8 SOLD OUT." One of the detergent tanks (from 1 to 8 depending on the number actually present) has run out. Refill or replace.
-	POWER FAILURE	"POWER FAILURE" appears on the display. During the execution of a program, the power supply failed. When the power supply is restored, the machine waits 40 seconds while the word "POWER FAILURE" flashes on the display. You can restart the cycle from where it left off by pressing the "START" icon.
-	RED LED ON CLEAN SIDE	When the red light on the clean side of the aseptic washer comes on, it means that an alarm has been generated. The alarm type appears on the dirty side display.

For any other type of message not present in the table, refer to the manufacturer's site.

35. PROGRAMS IN MEMORY

The machine has a number of pre-configured programs in its memory, which can still be modified.

NOTE: In rigid washing machines, the maximum speed is lower than in superspin machines. In addition, the spin speed is purely indicative and varies according to the capacity of the machine (check the actual value of the G-factor in the machine's technical data sheets).

Below is a brief description of the standard programs already in memory.

Special configurations of the machinery may include the integration of a dedicated set of programs.

	NAME	PREWASHING	WASHING	RINSE	CENTRIFUGAL
0	QUICK PROG	SEE THE RELEVANT CHAPTER			
1	WHITES 85°C WHITE	3', 40°C	5', 85°C, 24"/6"/24", 40rpm	3	3+1 (5', max rpm)
2	BIANCHI 75°C WHITE	3', 40°C	5', 75°C, 24"/6"/24", 40rpm	3	3+1 (5', max rpm)
3	NORMALE 60°C NORMAL	3', 30°C	3', 60°C, 24"/6"/24", 40rpm	3	3+1 (5', max rpm)
4	NORMALE 40°C NORMAL	3', 30°C	3', 40°C, 24"/6"/24", 40rpm	3	2+1 (5', max rpm)

	NAME	PREWASHING	WASHING	RINSE	CENTRIFUGAL
5	LANA 30°C WOOL	3'	3', 30°C, 2"/10"/2",	3	1 (1', 1/2 max rpm)
			30rpm		
6	MICROFIBRA 60°C MICROFIBER	5'	5', 60°C, 24"/6"/24",	3	3+1 (5', max rpm)
			40rpm		
7	MICROFIBRA 40°C MICROFIBER	5'	5', 40°C, 24"/6"/24",	3	3+1 (5', max rpm)
			40rpm		
8	LAVAGGIO RAPIDO 60°C QUICK WASH	-	3', 60°C, 24"/6"/24",	3	1; (5', max rpm)
			40rpm		
9	LAVAGGIO RAPIDO 40°C QUICK WASH	-	3', 40°C, 24"/6"/24",	3	1 (5', max rpm)
			40rpm		
10	SINTETICO 40°C SYNTHETIC	-	3', 40°C, 15"/15"/15"	3	2+1 (2', max rpm)
			40rpm		
11	DISINFEZIONE 85°C DISINFECTION	5', 40°C	3', 90°C, 24"/6"/24"	2+3	5+1 (5', max rpm)
			40rpm		
12	DISINFEZIONE 60°C DISINFECTION	5', 40°C	3', 60°C, 24"/6"/24"	2+3	5+1 (5', max rpm)
			40rpm		
13	DISINFEZIONE LANA 30°C WOOL DISINFECTION	3'	3', 35°C, 2"/20"/2"	1+3	1 (1', 1/2 max rpm)
			30rpm		
14	FORTE 85°C STRONG	5', 40°C	10', 90°C, 30"/3"/30"	3	3+1 (5', max rpm)
			40rpm		
15	FORTE 60°C STRONG	5', 40°C	10', 60°C, 30"/3"/30"	3	3+1 (5', max rpm)
			40rpm		
16	COLORED 60°C COLOR	-	3', 60°C, 10"/20"/10"	3	2+1 (5', max rpm)
			40rpm		
17	COLORED 40°C COLOR	-	3', 40°C, 10"/20"/10"	3	2+1 (5', max rpm)
			40rpm		

36. OTHER FUNCTIONS

There are many other features available that are continuously updated in the machine's software. Go to the manufacturer's website to download the software update files and check the new features of the machine.

37. MAINTENANCE OF THE WASHING MACHINE

Any ordinary or extraordinary maintenance work must be carried out by professionally qualified personnel. Make sure all power supplies are disconnected before performing any maintenance.

Ordinary and extraordinary maintenance is reported at the scheduled interval.

EVERY DAY

- The machine should be kept clean using neutral detergents. Clean the bodywork to remove all traces of soap, as well as the detergent drawer.
- Clean the door seals.
- Clean vents and vents
- Check the cleaning conditions of the basket: make sure there are no deposits.
- Check that the drain valve is not leaking
- At the end of the day, leave the door open in order to ventilate the interior
- At the end of the day, disconnect all power and water supplies
- Clean the ventilation filters of the electrical panel

EVERY THREE MONTHS

- Check valves, hoses and gaskets for leaks
- Check the quality of the drive belts and the cleaning conditions of the basket: make sure that there are no deposits.
- Check the cleanliness of the drain valve
- Check the cleanliness of the inlet valves and their filters

EVERY YEAR

An authorized technical assistance center should be consulted for:

- Perform cleaning of the inside of the machine
- Check the electrical contacts of the wiring harness for goodness
- Check the tightness and integrity of the rubber parts
- Perform greasing of mechanical parts that require it
- Clean the engine vents



ATTENTION!

In the case of tilting machines, before starting any maintenance, make sure that the air circuit is completely exhausted and that no movement of the pneumatic drives can occur, even in the absence of power supply. In the case of maintenance in non-resting positions of some drives, be sure to mechanically and safely lock all pneumatic drives.

38. WASHING PROBLEMS

In case there are poor results in washed fabrics, check the following table.

PROBLEM detected	Probable SOLUTION
The fabrics are still dripping with water.	Check that the programme ends with a final spin. It is possible that a series of imbalances have occurred: check the load and relaunch a centrifuge.
Fabrics come out with obvious drum marks	Check the spin speed, it is probably excessive.
The fabrics come out felted.	Check garment labels and compliance for use in the washing machine. Check the spin speed and temperatures of the cycle used.

39. USING THE TILTING MACHINE

The following clarifications must be added to the description of the previous paragraphs, in the event that the machine is equipped with a system for tilting the basket forward and/or backward.

The transport and locking stops of the tank must be removed according to the instructions given in the appropriate paragraph.

The pneumatic controls are managed by means of a remote push-button panel to perform forward lifting (unloading phase) or backward lifting (unloading phase).

It should be noted that the machine, depending on the option applied, can have the availability of forward tilting only, backward tilting only or both.

The description, from now on, will be related to the machine equipped with both drives.



ATTENTION!

When the machine is tilting, or pneumatically opening the door (if present), the operator must keep out of reach of the machine and the door, using the appropriate remote push-button panel.

The user must be aware of the dangers of crushing and truncation between the tilting elements and other

machines or structures in the building!

When the tilting phase is not active, the "CRADLE UNLOCKED" LED is lit on the front of the machine.



ATTENTION!

During tilting operations, the door must be locked with the appropriate latch, so as to prevent the door from tilting freely while the machine is raising or lowering.

The tilting phase can only be activated if the door is open.

To activate the tilting function, it is necessary to hold the remote control with both hands and activate it via the selector which must be moved from position "0" to position "1".

When the remote control is activated, the green LED on the keypad lights up. From here on, the use of the remote control buttons will be described.



ATTENTION!

Each button on the remote control will work, if and only if it is pressed at the same time as the green button on the remote control itself.

Before allowing the tilting movement, the cradle must be locked. It is therefore essential to press and hold the "BLOCCO CULLA / CRADLE LOCK" button until the green LED on the front of the machine lights up.

At the same time, both LEDs must also light up:

- "TILTING AVANTI ENABLED / FORWARD ENABLED"
- "TILTING BACKWARD ENABLED"

Only after that, you can activate the lifting of the machine:

- forward (FORWARD – UP / FORWARD-UP)
- backward (BACKWARD-UP) by pressing the corresponding buttons on the remote control.



ATTENTION!

During FORWARD movement, only the "TILTING FORWARD ENABLED" led will remain on.

When only this LED is lit, the only working tilting controls are those that act on forward tilting

During the BACKWARD movement, only the "TILTING BACKWARD ENABLED" led will remain lit.

When only this LED is on, the only working tilting controls are those that act on tilting back

To return the machine to the wash position, use the opposite controls (FORWARD-DOWN or BACKWARD DOWN).

When the machine is in the wash position, both LEDs:

- "TILTING AVANTI ENABLED / FORWARD ENABLED"
- "TILTING BACKWARD ENABLED"

must be turned on.

In this situation, activate the CRADLE UNLOCK / CRADLE UNLOCK control until the relative LED on the front of the machine lights up.

At the end, deactivate the remote control by setting its selector in the "0" position: the green LED of the remote control goes out.

Only in the latter condition can the washing machine be used in a standard way.



ATTENTION!

Use the maintenance stop, supplied with the machine, to carry out checks, cleaning and service operations located on the bottom of the tank or under the machine. The maintenance stop ensures the support of the tank

and prevents its movement. The maintenance stop can be installed both front and rear, depending on whether the machine is a 1-way tilting type (front lift only or rear only) or 2-way tilting (alternating front and rear lift). To install the maintenance stop, lift the machine from one of the desired directions, place the maintenance stop as shown in the next figure, make sure that the maintenance stop is correctly interposed between the base and the upper part of the machine that must remain locked. Turn off the machine at the main switch and make sure that the water and air lines have been closed upstream of the machine.

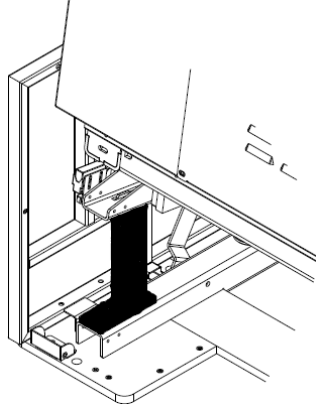

40. EASY DOWNLOAD

For machines that are equipped with it, the EASY DOWNLOAD function facilitates the unloading of laundry, by slowly rotating the drum during the laundry unloading phase.

To activate the function, simply press and hold the "EASY DOWNLOAD" button on the front of the machine, and at the same time, press one of the icons on the display: CLOCKWISE ROTATION or COUNTERCLOCKWISE ROTATION.

NOTE: The basket can only be rotated if the button and one of the icons are held down at the same time.

41. PROCEDURE FOR CHECKING SAFETY DEVICES

After switching on the machine, before starting the cycle, it is always necessary to check the perfect functioning of the safety devices, The user must always scrupulously carry out the following procedure:

Sequence of ACTIONS	CONSEQUENT REACTIONS
Start a cycle and press STOP...	... The machine must stop and wait for a new start.
Start the cycle and check that the door is locked. Use fast-forward to get to the bottom program and Make sure that the door cannot be opened until after the end of the programme: with the basket completely stopped.
Operate the emergency mushroom (if fitted) The basket must stop and the machine must be switched off.



ATTENTION!

After switching on the machine and before starting work, it is always necessary to check that all safety devices are working perfectly.

42. SCRAPPING

When the life cycle of the machine is over, proceed with the scrapping according to the regulations in force, separating the metal parts from the plastic parts, from the glass parts, from the electrical/electronic parts.



The crossed-out wheeled bin symbol on the appliance or its packaging indicates that the product at the end of its useful life must be collected separately from other waste.

The separate collection of this equipment at the end of its life is organized and managed by the manufacturer. The user who wishes to dispose of this equipment must therefore contact the manufacturer and follow the system that the manufacturer has adopted to allow the separate collection of the equipment that has reached the end of its life.

Adequate separate collection for the subsequent recycling, treatment and environmentally compatible disposal of discarded equipment helps to avoid possible negative effects on the environment and health and promotes the reuse and/or recycling of the materials of which the equipment is made. Illegal disposal of the product by the holder will result in the application of the penalties provided for by current legislation.



ATTENTION!

If the machine is put into disuse, before disposal, dismantle the door, so that no one can close themselves inside it at the risk of their life.

43. WARRANTY CONDITIONS

For warranty conditions, please refer to the manufacturer's price list.



ATTENTION!

In order to take advantage of the manufacturer's warranty, the requirements contained in the manual must be scrupulously observed, and in particular:

- always operate within the limits of the machine's use;
- always carry out constant and diligent maintenance;
- use the machine with suitably trained personnel;
- use only original spare parts indicated by the manufacturer;
- comply with contractual obligations or the rules dictated by the offer to which the buyer has adhered.