



MOD : PD15/A7-R2C

Production code : OM150PSVGD110SH_1

10/2025

Rev.	Modification	Date
00	Prima Emissione	06/09/2022
01		30/09/2024

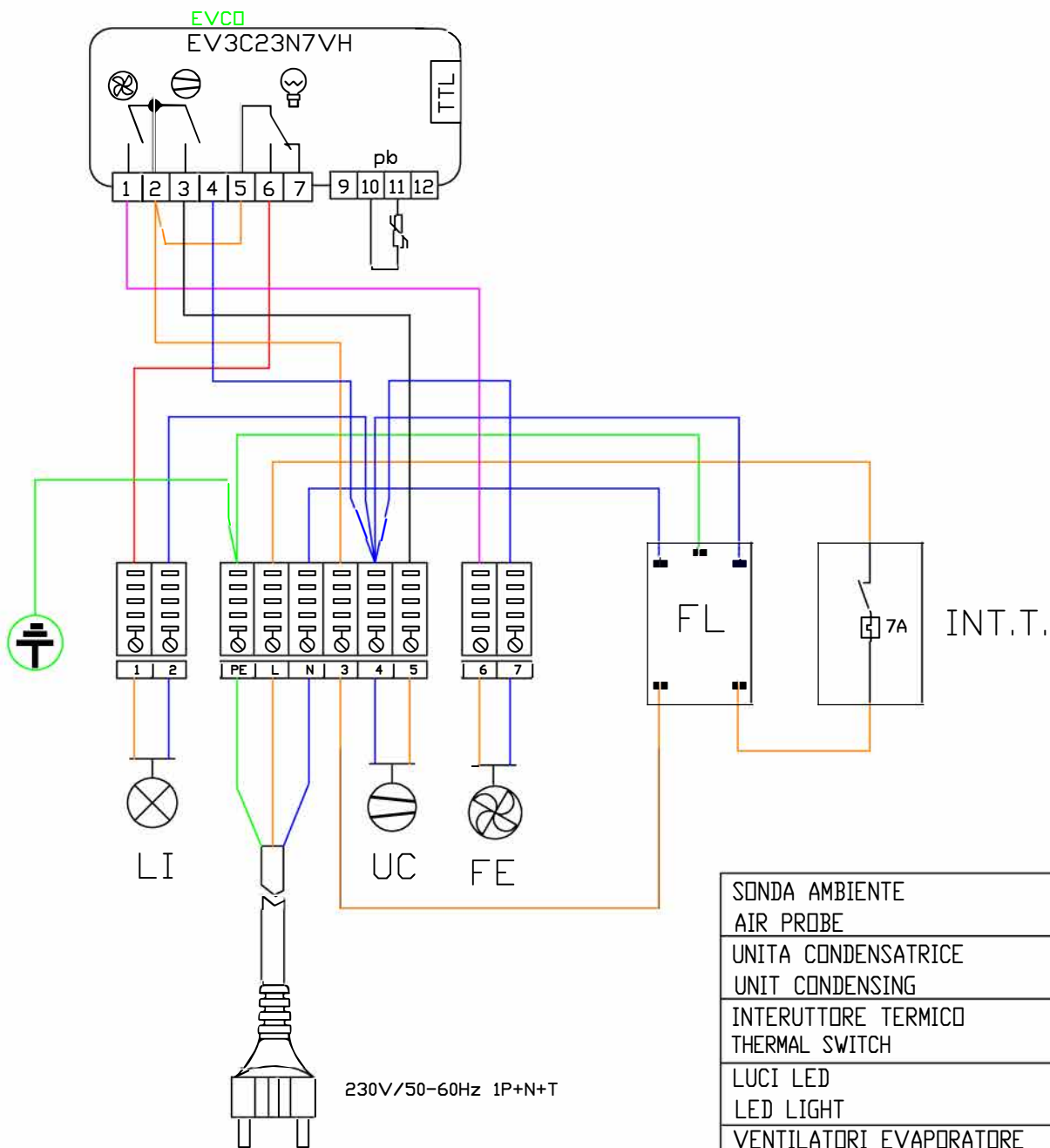

SONDA AMBIENTE AIR PROBE	pb
UNITA CONDENSATRICE UNIT CONDENSING	UC
INTERUTTORE TERMICO THERMAL SWITCH	INT.T.
LUCI LED LED LIGHT	LI
VENTILATORI EVAPORATORE EVAPORATOR FAN	FE
FILTRO ANTIDISTURBO SUPPLY FILTER	FL

INSTALLARE UN QUADRO ELETTRICO DI POTENZA QUANDO E' SENZA GRUPPO
INSTALL A POWER ELECTRICAL PANNEL WHEN AN WITHOUT THE GROUP

Approved By:	Electrical Schematic	Date
	Model	Padova Line
	Details:	PD10/B5(A7)-R2C , PD12/B5(A7)-R2C, PD15/B5(A7)-R2C, PD18/B5(A7)-R2C, PD20/B5(A7)-R2C
	Dettagli:	STANDARD

IL FRIGORIFERO DEVE ESSERE ALLACCIATO AD UN INTERRUPTORE DIFFERENZIALE ONNIPOLARE ADEGUATO ALLA POTENZA CON id=0,03A E COLLEGATO ALL'IMPIANTO DI MESSA A TERRA