

**MOD : MA20/E8-R2V**

**Production code : BK200PBCGD110H**

# MA20/E8-R2V

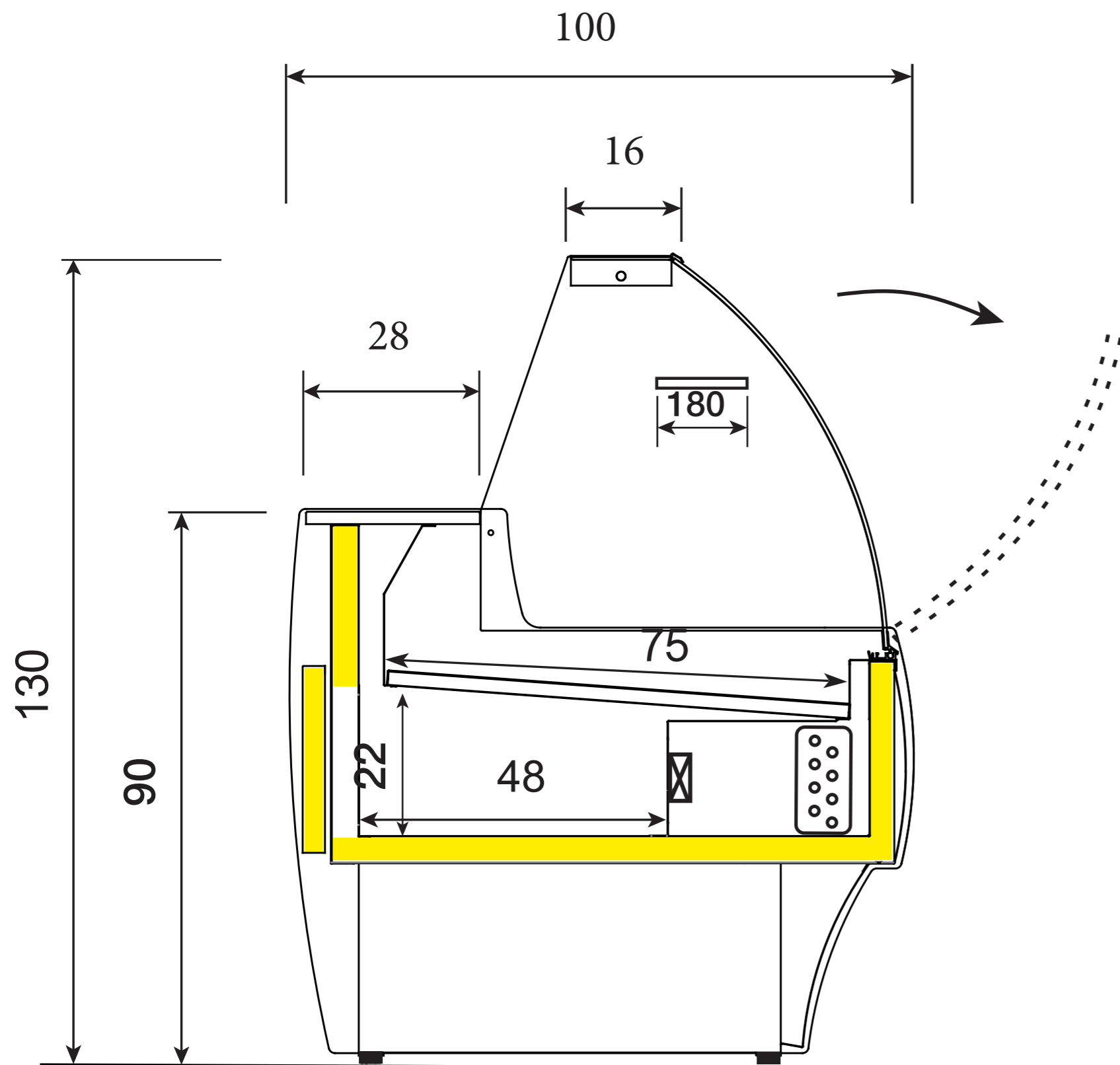

MODELLO	LUNG. LENGTH LAENGE LONGUEUR	MOTORE COMPRESSOR KOMPRESSOR COMPRESSEUR	ILLUMINAZIONE LIGHTING BELEUCHTUNG ILLUMINATION	QUANTITA' GAS GAS QUANTITY GAS MENGE QUANTITE' DE GAS (KG.)	TIPO DI GAS KIND OF GAS GAS-TYP TIPE DE GAZ	HP	Potenza frigorifera Refrigeration power Kalteleistung Puissance frigorifique Watt (-10°C)	Watt assorbiti compressore + motovent. Watt absorbed Nennleistungsaufnahme Watts absorbés	Assorbimento Ventilatori Vasca Fab absorption Luefteraufnahmen Absorption ventilateurs	OPT.Watt vaschetta elettr. Electric pan Elektrische Wanne Bac électrique	Lt. Piano espositivo liters exhibition floor Liter Ausstellungsfläche sol d'exposition litres	Lt. cella Ceell liter capacity Zelle Liter Kapazität Capacité en litre de cellule
	<b>VENTILATO - UMLUFT - AIRY - VENTILE - VENTILADA</b>											
<b>Mantova EVO</b>	150	NLE8,8CN	1 x 13w	0,100	R290	1/2- HP	690	326+38	18	270	136	151
	200	NLE11CN	1 x 16w	0,140	R290	1/2 HP	873	422+73	36	270	185	205
	250	SC15MNX	2 x 10 w	0,147	R290	3/4 HP	1054	599+73	36	270	234	259
	300	SCE21MNX	2 x 13 w	0,150	R290	1- HP	1396	724+146	54	270	282	313



I dati tecnici possono essere soggetti a cambiamenti senza alcun obbligo di preavviso. We reserve the right to change technical features without notice. Technische aenderungen sind ohne voranzeige moeglich. Nous nous reservons le droit de varier sans preavis les details techniques.