



MOD : FC25/G8-VR2

Production code : OP250PSCG160H

10/2025

Rev.	Modification	Date
00	Prima Emissione	22/09/2022

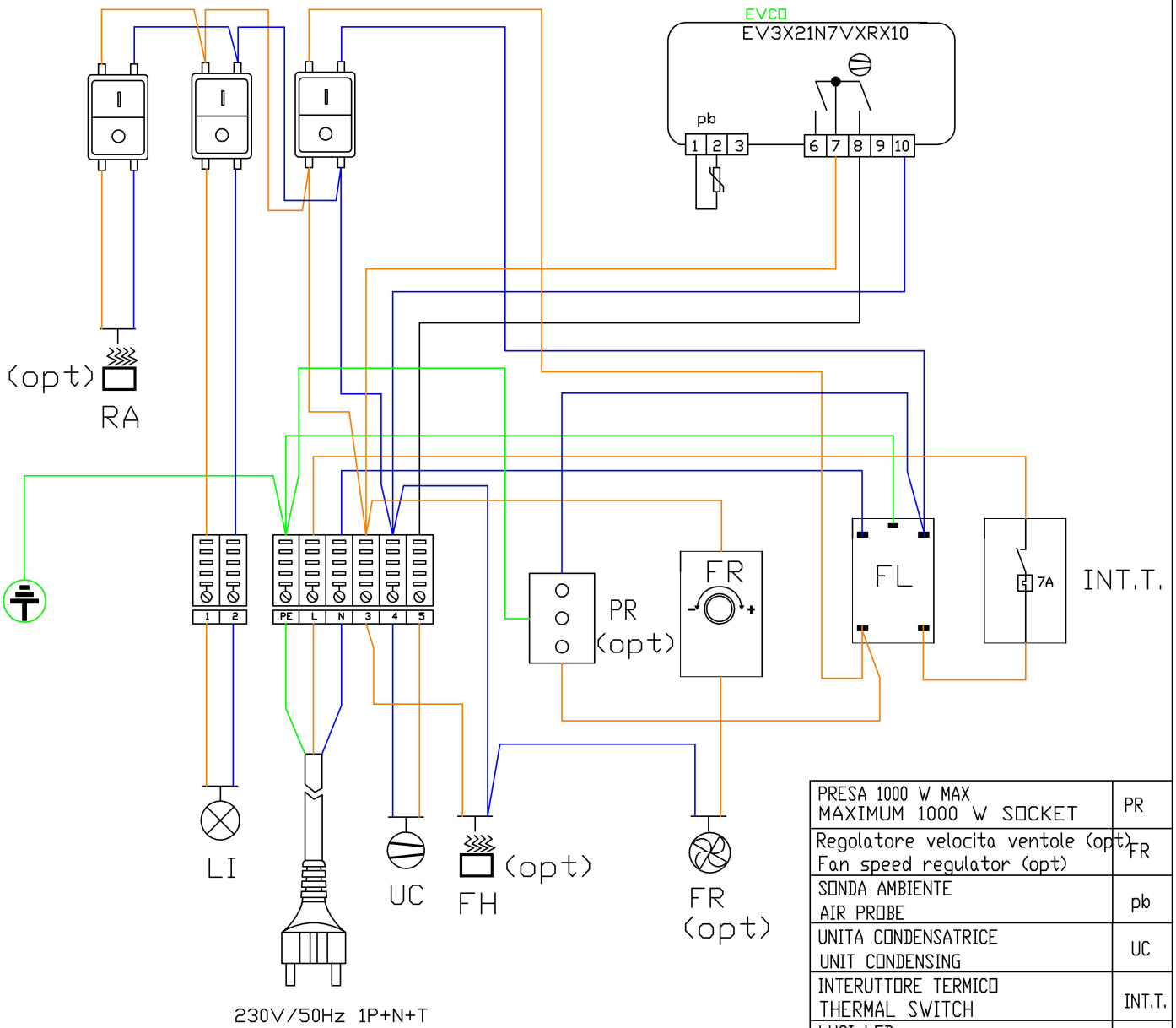

PRESA 1000 w MAX MAXIMUM 1000 w SOCKET	PR
Regolatore velocita ventole (opt) Fan speed regulator (opt)	FR
SONDA AMBIENTE AIR PROBE	pb
UNITA CONDENSATRICE UNIT CONDENSING	UC
INTERRUTTORE TERMICO THERMAL SWITCH	INT.T.
LUCI LED LED LIGHT	LI
VENTILATORI EVAPORATORE EVAPORATOR FAN	FE
RESISTENZA EVAP.ACQUA (opt) HEATER WATER (opt)	FH
RESISTENZA ANTIAPPANNANTE (opt) ANTI-FOG RESISTANCE (opt)	RA
FILTRO ANTIDISTURBO SUPPLY FILTER	FL

Approved By:	Elettrical Schematic		Date
	Model	Venice Line-Florence Line Molina-Melody Plus	22/09/2022
	Details:	100-150-200-250-300 VENTILATI	Drawing Nr. 220052

IL FRIGORIFERO DEVE ESSERE ALLACCIATO AD UN INTERRUTTORE DIFFERENZIALE ONNIPOLARE ADEGUATO ALLA POTENZA CON id=0,03A E COLLEGATO ALL'IMPIANTO DI MESSA A TERRA