



MOD : CF1B/F64

Production code : AF64X2521-DM

10/2025

CONTROLLED PROVING CABINETS



INSTALLATION, OPERATING AND MAINTENANCE INSTRUCTIONS



GB

The manufacturer reserves the right to modify the appliances presented in this publication without notice.

GB

1. INDEX

1. INDEX.....	1
2. ANALYTICAL INDEX.....	2
3. SAFETY.....	3
4. REGULATIONS AND GENERAL INSTRUCTIONS.....	4
4.1. General Information.....	4
4.2. Warranty.....	4
4.3. Replacement of Parts.....	4
4.4. Description of the Appliance.....	5
4.5. Features Plate.....	6
4.6. Safety Devices.....	7
4.7. Personal Protective Equipment.....	7
4.8. Further Risks.....	8
5. TRANSPORT AND STORAGE.....	9
5.1. General Information.....	9
5.2. Transport and Handling.....	9
5.3. Storage.....	9
6. INSTALLATION.....	10
6.1. Packing and Unpacking.....	10
6.2. Installation.....	10
6.3. Electric Power Supply Connection.....	12
6.4. Water connection.....	13
6.5. Inspection.....	14
7. USE AND FUNCTIONING AND FUNCTIONING.....	15
7.1. First Power On.....	15
7.2. General Settings.....	17
7.3. Service.....	19
7.4. Use of the USB port (Optional).....	19
7.5. Manual Refrigeration Cycle.....	20
7.6. Manual Heating Cycle.....	22
7.7. Pre-cooling.....	24
7.8. Fermentation Cycle.....	25
7.9. Recommendation for Use.....	29
8. CLEANING AND MAINTENANCE.....	30
8.1. Recommendations for Cleaning and Maintenance.....	30
8.2. Routine Maintenance.....	30
8.3. Extraordinary Maintenance.....	31
8.4. Maintenance intervals.....	32
9. FAULTS.....	33
9.1. Alarms Display.....	36
10. TECHNICAL NOTES.....	38
10.1. Assembly kit accessory wheels.....	38
10.2. Reversibility of the Doors.....	39
11. DISPOSAL OF THE EQUIPMENT.....	41
11.1. Waste Storage.....	41
11.2. Equipment disassembly procedure.....	41
12. TECHNICAL DATA SHEET OF REFRIGERANT R290.....	42
ATTACHMENTS.....	I

2. ANALYTICAL INDEX

A

Alarm Safety Thermostat Steam Generator; 37
 Alarms Display; 36
 Assembly kit accessory wheels; 38

C

Cabinet Probe Alarm; 36
 Condenser Probe Alarm; 36

D

Date/Time Setting; 17
 Description of the Appliance; 5
 Disposal of the Equipment; 41

E

Electric Power Supply Connection; 12
 Equipment disassembly procedure; 41
Evaporator Probe Alarm; 36
 Extraordinary Maintenance; 31

F

FAULTS; 33
 Features Plate; 6
 First power on; 15
 Further Risks; 8

G

General Information; 4; 9

H

High Evaporator Temperature Alarm; 37
 Humidity Probe Alarm; 37

I

Inspection; 14
 Installation; 10

L

Languages; 18

M

Maintenance Intervals; 32
 Manual Heating Cycle; 22
 Manual Refrigeration Cycle; 20

O

Open Door signal; 37

P

Packing; 10
 Personal Protective Equipment; 7
 Prolungata Inattività; 29

R

Reccomendation for Use; 29
 Recommendations for Cleaning and Maintenance;
 30
 Recommendations for normal use; 29
 Replacement of Parts; 4
 Reversibility of the Doors; 39
 Routine Maintenance; 30
 RTC Alarm; 36

S

SAFETY; 3
 Safety Devices; 7
 Safety Thermostat Vapour Generator; 7
 Storage; 9

T

Technical Data Sheet of Refrigerant R209; 42
 Transport and Handling; 9

U

Unpacking; 10

W

Warranty; 4
 Waste Storage; 41
 Water connection; 13

3. SAFETY



It is recommended to carefully read to the instructions and warnings contained in this manual before using the appliance.



Keep this manual carefully so that it can be consulted when necessary.



The electrical plant has been designed in compliance with the **IEC EN 60335-2-89** standard.



The sound pressure level emitted by the equipment is less than 70dB(A). The value may increase depending on the workplace where it is measured.



Maintain ventilation openings in the appliance casing or in the built-in structure free from all obstructions.



Do not use mechanical devices or other means to accelerate the defrosting process other than those recommended by the manufacturer.



Do not damage the refrigerant circuit.



Do not use electrical appliances inside the appliance compartments for storing frozen foods.



Do not store explosive substances, such as pressurised containers with flammable propellants, in this appliance.



Do not place objects on the bottom of the appliance. Use the appropriate racks to store the product.



The maximum load allowed per grid is 45Kg evenly distributed.



The replacement of the damaged power cable must be performed by qualified personnel.



Specific stickers highlight the presence of mains voltage near areas (in any case protected) with electrical risks.



Before connecting, make sure that the means for disconnecting the appliance from the electricity mains are fitted in the fixed system in accordance with the installation rules (required for appliances supplied without plug to be connected to a fixed system).



In the design and construction phase, the manufacturer has paid particular attention to the aspects that can cause risks to safety and health of persons that interact with the appliance.



Carefully read the instructions stated in the manual and those applied directly to the machine, and particularly respect those regarding safety.



Do not tamper with or eliminate the safety devices installed. Failure to comply with this requisite can lead to serious risks for personal health and safety.



It is recommended to simulate some test manoeuvres to identify the commands, in particular those relating to switching on and off, and their main functions.



The equipment is intended only for the use for which it was designed; any other use is to be considered improper.



The manufacturer declines all liability for any damage to objects or injury to persons owing to improper or incorrect use.



All maintenance interventions that require precise technical skill or particular ability must be performed exclusively by qualified staff.



Do not under any circumstances stress the power cable.



The safety devices must be subjected to periodic inspections as indicated in the chapter on extraordinary maintenance.

 In order to guarantee hygiene and protect the foodstuffs from contamination, the elements that come into direct or indirect contact with the foodstuffs must be cleaned very well along with the surrounding areas. These operations must only be performed using detergents that can be used with foodstuffs, avoiding inflammable

products or those that contain substances that are harmful to personal health.

 In case of prolonged inactivity, in addition to disconnecting all the power supply lines, it is necessary to thoroughly clean all the internal and external parts of the appliance.

4. REGULATIONS AND GENERAL INSTRUCTIONS

4.1. General Information

This manual has been designed by the manufacturer to provide the necessary information to those who are authorised to interact with the appliance.

It is advisable for the receivers of the information to read it carefully and apply it strictly.

Reading the information contained in this document will allow the user to prevent risks to personal health and safety.

Keep this manual for the entire operating life of the appliance in a place that is well-known and easily accessible, so that it is always available when its consultation becomes necessary.

Particular symbols have been used to highlight some parts of the text that are very important or to indicate some important specifications. Their meanings are given below:



Indicates important safety information. Appropriate behaviour must be adopted in order not to endanger the health and safety of people and not to cause damage.



Indicates technical information of particular importance that should not be ignored.

The equipment has been designed for the refrigeration of food. Any other use is considered improper.



The equipment is not intended to be used by:

- persons whose physical, sensory or mental capacities are impaired.
- children
- persons with lack of experience and / or knowledge of the product / process.



The equipment is not suitable for installation outdoors and/or in environments subject to the action of atmospheric agents such as sun, rain, etc.

4.2. Warranty

The warranty of the appliance and the components of our production has a duration of 2 years from the date of shipment and translates into the supply, free of charge, of parts, which, in our sole discretion, are found to be defective.

These faults must, however, be independent from incorrect use of the product in compliance with the indications stated in the manual.

Fees deriving from labour, travel and transport are excluded from the warranty.

The materials replaced under warranty are our property and must therefore be returned under the responsibility and expense of the customer.

4.3. Replacement of Parts



Before carrying out any replacement operations, activate all envisioned the safety devices.



In particular, disconnect the equipment from the electrical power supply using the differential isolator switch and pull the plug to disconnect the machine.

Only use original spare parts to replace worn components.

i We decline all responsibility for damage and malfunctions caused by:

- non-compliance with the instructions contained in this manual;
- repairs not performed in a workmanlike manner;
- use of non-original spare parts;
- interventions by non-skilled technicians;
- unauthorized interventions;
- lack of preventive maintenance;

- improper use of the equipment
- unpredictable events
- use of the equipment by insufficiently trained staff;
- non-application of the provisions on safety and hygiene in the workplace, in force in the country of use.

i We accept no liability for damage caused by conversions and/or modifications made by the end user.

4.4. Description of the Appliance

The refrigerated cabinet, hereinafter referred to as equipment, was designed and built for the preservation of foodstuffs in the professional catering sector.

- 1) condensation area:** it is disposed in the upper part and is characterized from the presence of the condensing unit.
- 2) electrical area:** it is positioned in the upper / front part and contains the control and power supply appliance as well as the electrical wiring.
- 3) cooling / heating area:** is located inside the cell compartment and is characterized by a cooling unit plus a heating unit.
- 4) storage area:** it is located below the evaporating unit and is intended for food storage.

The upper part is characterized by a dashboard that allows access to the electrical parts.

In the front, there is a door, with vertical opening, which hermetically closes the refrigerated compartment.

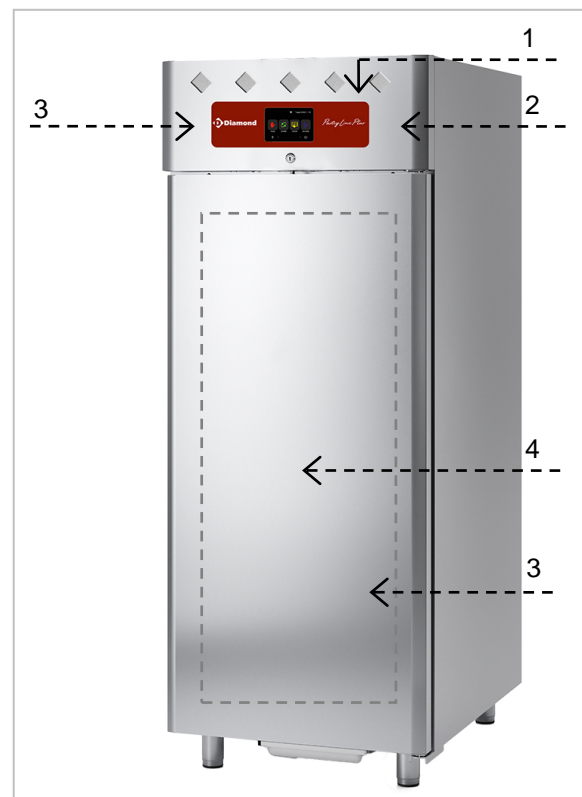

Depending on the needs of use, the equipment is produced in several versions:

Retarder Prover Cabinet 60x40

(-3°C +35 °C)

Model designed for 60x40 pastry trays. This model is indicated in the preservation of products at a positive temperature.

Retarder Prover Cabinet 60x80

(-3°C +35 °C)

Model designed for 60x80 pastry trays. This model is indicated in the preservation of products at a positive temperature.

Retarder Prover Cabinet 60x40

(-20°C +35 °C)

Model designed for 60x40 pastry trays. This model is indicated in the preservation of products at a positive or negative temperature.

Retarder Prover Cabinet 60x80



(-20°C +35 °C)

Model designed for 60x80 pastry trays. This model is indicated in the preservation of products at a positive or negative temperature.

4.5. Features Plate

The identification plate shown is applied directly to the equipment. It contains the references and all the information essential for working in safety.

- 1) Equipment code
- 2) Description of the Equipment
- 3) Serial number
- 4) Power supply voltage and frequency
- 5) Rated Output
- 6) Defrosting output
- 7) Total Lamp Output
- 8) Climatic class
- 9) Type and Amount of refrigerant gas
- 10) Number of the refrigerant of the main expanding gas component of the insulation foam.
- 11) WEEE Mark

		2018
Code Kode Codice	XXXXXXXX	①
Descrizione / Description	XXXXXXXX XXXXXXXX	②
Serial No./ Serien Nr./ Matricola	XXXX.XXXX	③
Tension / Spannung / Tensione	xxx V~ xx Hz	④
Input / Leistungsaufnahme / Potenza	xxx W xxx A	⑤
 Defrost Power / Potenza Sbrinamento	xxx W	⑥
Climate Class / Klimaklasse / Classe Climatica	5	⑧
Refrigerant Kuehlmittel Refrigerante	xxxx xxxx Kg	⑨
Insulation Isolierung Isolamento	HFO1233zd	⑩
⑪		CE
	Max  xx W	⑦

The climatic class described on the features plate refers to the following values:

Blind door models

Climate Class	EN 60335-2-89	EN ISO 23953	
	Room Temperature	Room Temperature	Relative Humidity
5	43°C	40°C-	40%
4	32°C	30°C-	55%

Glass door models

Climate Class	EN 60335-2-89	EN ISO 23953	
	Room Temperature	Room Temperature	Relative Humidity
4	32°C	30°C-	55%

4.6. Safety Devices

The Equipment is supplied with the following safety systems:

- 1. Safety Thermostat Vapour Generator** : blocks the electrical power supply in the event of excessive overheating.

The intervention of the safety thermostat activates the alarm.

The illustration indicates the position of the safety thermostat.



Check daily that the safety devices are installed correctly and efficient.

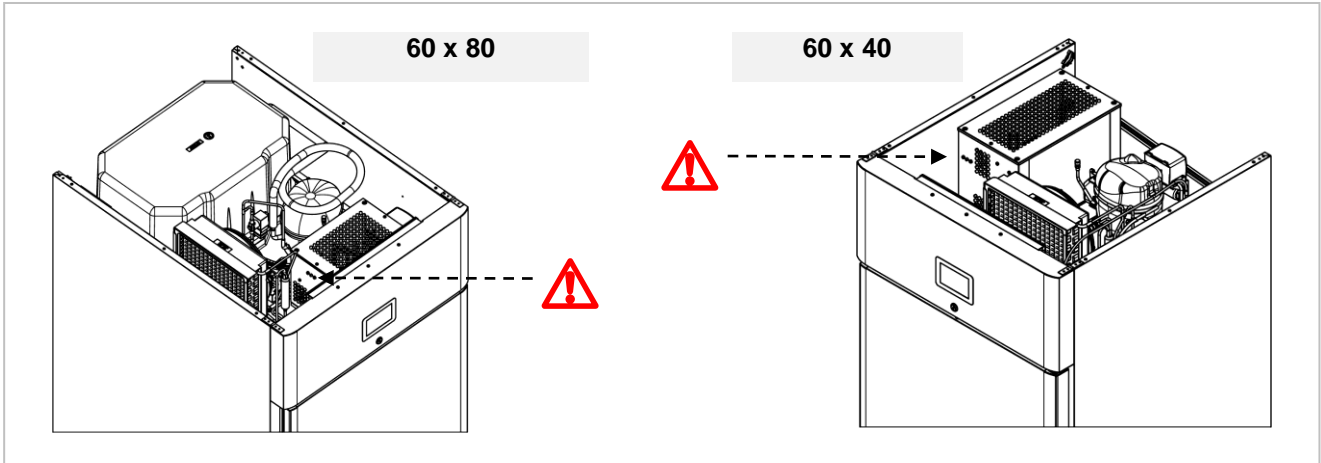

GB

4.7. Personal Protective Equipment

The identification and selection of appropriate personal protective equipment is the responsibility of the employer or workplace manager or service technician.

Operators are required to wear the identified equipment.

During ordinary use, gloves protect your hands from the cold pan.

Below is a list of the main personal protective equipment (PPE) to be used during the various work operations.

Task	Protective Clothing	Safety Shoes	Gloves	Glasses	Helmet or Hard hat
Transport and handling		■	□		□
Unpacking		■	□		
Assembly		■	□		
Ordinary use	■	■	□		
Routine cleaning	□	■	■	□	
Extraordinary cleaning	□	■	■	□	
Maintenance	□	■	□		
Dismantling	□	■	□		
Scrapping	□	■	□		

■ Mandatory Personal Protective Equipment (PPE)

□ Personal Protective Equipment (PPE) to be used if necessary

4.8. Further Risks

The proper design of the equipment and the installation of adequate protection do not completely exclude risks to the operator.

This manual lists the personal protective equipment that to be used by the operator.

Sufficient space is provided during the installation of the equipment to limit the risks. To maintain these conditions, the areas surrounding the equipment must be kept clean, dry, well lit and free of obstacles.

The following is a list of possible risks that may still occur.

Possible risk	Description
Slip or fall	The operator may slip due to water, oil or dirt on the floor.
Burns Abrasion	The user intentionally or unintentionally touches some internal components of the appliance (for example cold trays, fins and pipes of the cooling circuit) without using protective gloves.
Electrocution	Contact with live electrical parts during maintenance operations performed without cutting off the power supply.
Fall	The operator intervenes on the equipment using unsuitable means to access the upper part.
Injuries	The upper control panel may not be secured properly by qualified personnel. It may close abruptly.
Tipping	During equipment and packaging handling operations using unsuitable lifting and/or handling equipment or with an unbalanced load.
Cooling gas	Inhalation of cooling gas. The type of refrigerant can be found on the equipment's identification plate.

5. TRANSPORT AND STORAGE

5.1. General Information

The equipment must be transported and handled using appropriate means with adequate capacity.

 During the transport and handling of the equipment, it is strictly forbidden to stack one machine on top of the other; in order to exclude the risk of loads tipping over due to stacking.

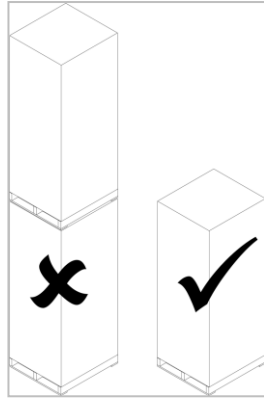



 The equipment must only be transported, handled and stored by skilled staff. Minimum requirements for skilled staff are as follows:

- specific technical training and experience in the use of lifting systems;
- knowledge of safety regulations and applicable laws;
- knowledge of the general safety requirements;
- respect in adopting the individual protection devices suitable for the type of operation performed;
- the ability to identify in advance and avoid any possible danger.

5.2. Transport and Handling

 It is forbidden to stand under suspended loads during handling and transport. Unauthorised personnel may not enter the work area. The transported load can move when braking, accelerating, cornering and on rough roads.

 The equipment must be handled in a vertical position. It is forbidden to move the equipment in a horizontal position. If the equipment is handled in a horizontal position, wait a few hours before operating it. For the correct performance of lifting operations, use the most suitable type of equipment in terms of characteristics and load capacity: forklift or transpallet.

 Avoid pushing or dragging the equipment when handling it.

 Before lifting, secure the surrounding area and prevent access to personnel. Move the equipment to a minimum height above the ground and ensure the stability of the load.

 Do not lift the equipment in any other way than explained in this manual. Before placing the load, check that the floor is level and has sufficient load-bearing capacity to support the weight of the load.

5.3. Storage

 The equipment must be stored in a non-aggressive, vibration-free environment.

 The room temperature should be between -10°C and +50°C. Avoid excessively humid environments. The storage area must have an

adequate support surface to prevent deformation of the machine or damage to the support feet.

 Only skilled staff is allowed to perform positioning, assembly and disassembly of the equipment.

6. INSTALLATION

6.1. Packing and Unpacking

Move and install the appliance respecting the information provided by the manufacturer, shown directly on the packaging, on the appliance and in this manual.

 Wear protective gloves before unpacking.

 Avoid pushing or dragging the equipment to avoid the risk of overturning and damage to the structure.

The lifting and transportation system of the packaged product envisages the use of a fork-lift truck or a pallet stacker, using which particular attention must be paid to balancing the weight in order to prevent the risk of overturning (avoid excessive tilting!).

 **ATTENTION:** When inserting the lifting device, pay attention to the power cord and the position of the feet.

 **ATTENTION:** given the presence of concentrated weights in the upper part of the equipment, avoid dragging it when moving (danger of overturning and damage to the feet).

The packaging is made of cardboard and the pallet is made of wood. A series of symbols is printed on the cardboard packaging, which, according to international standards, highlight the requirements to which the equipment must be subjected during loading and unloading, transport and storage operations.



6.2. Installation

 Installation and assembly operations must be carried out by qualified professionals. If the appliance uses R290 refrigerant, every possible precaution must be taken to avoid any danger related to the flammability of this gas.

On delivery, check that the packaging is intact and has not been damaged during transport. Any damage must be immediately reported to the carrier.

The equipment must be unpacked as soon as possible to check its integrity and the absence of damage.

Do not cut the cardboard with sharp tools in order to prevent damage to the steel panels underneath.

Remove the cardboard packaging upwards.

After unpacking the equipment, check that the features correspond to those requested in the order.

For any anomalies, contact the retailer immediately.

 On stainless steel equipment, carefully remove the protective film from the inner and outer walls, avoiding the use of metal tools.

If any adhesive remains on the walls of the machine, remove it using a non-corrosive solvent; rinse and dry thoroughly after cleaning. It is recommended to apply a protective oil film to all steel surfaces.

 Packaging elements (nylon bags, polystyrene foam, staples ...) must not be left within the reach of children

Remove the protective PVC film from the internal and external walls avoiding the use of metal tools.

 Inside the cooling compartment, guides for the tray are located at the bottom.

 Packaging must be disposed of in compliance with the regulations in force in the country where the equipment is used.

 All installation phases must be considered starting from the very realization of the general project.

 Installation and assembly operations must be carried out in accordance with current safety regulations.

 The equipment used for installation and assembly operations must comply with current safety standards.

The installation area must be equipped with all power supply and production residue drainage connections and must be suitably lit and respect current laws regarding hygiene and sanitary requirements.

 To optimize consumption and reduce wear on the machine, do not place it near heat sources or in environments with excessively high temperatures. Proceed to level the appliance by acting on the individual feet.

 It is essential that the equipment is level; otherwise, the operation of the machine may be impaired.

Install the equipment so that the workstation is positioned in front of the control panel.

 **ATTENTION:** the equipment requires minimum functional spaces as shown in the diagram.

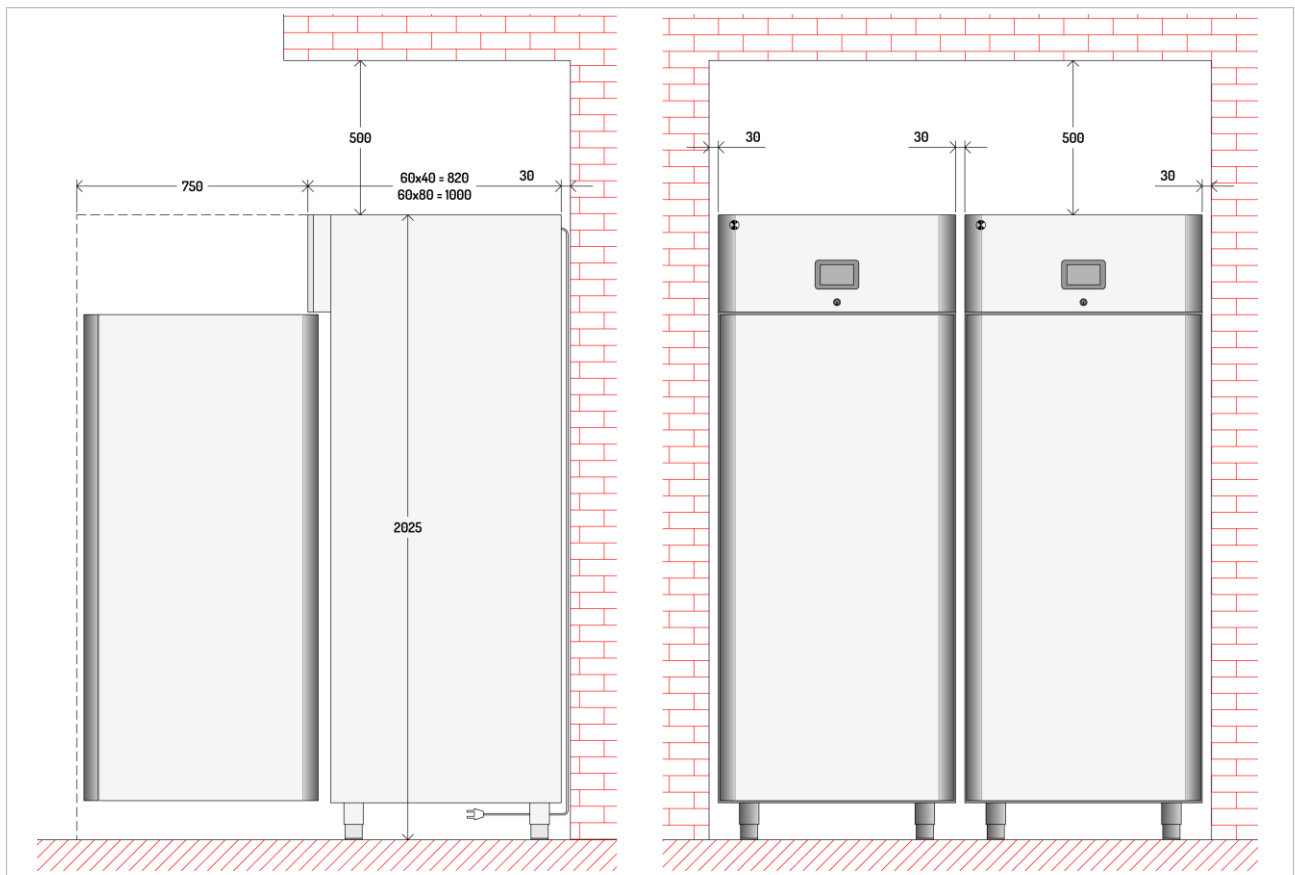

 Do not push or drag the unit during installation to prevent it from falling over or causing damage to parts or people.

 This equipment can only be installed and operated in permanently ventilated rooms, to guarantee correct operation.

 Plug in and then leave on for a while (at least two hours) before checking operation. During transport, it is likely that the compressor lubricating oil has entered the refrigerant circuit blocking the capillary: consequently the equipment will work for some time without producing cold until the oil has returned to the compressor.

 The size of the compartment that houses the equipment must be such as to avoid excessive concentrations of gas in the event of a leak from the refrigeration circuit and in any case, the compartment must have a free area NEVER smaller than 4 times the space occupied by the equipment. Adequate space must be provided to ensure effective escape routes at all times. The aforementioned compartment must be well ventilated.

6.3. Electric Power Supply Connection

 The connection must be carried out by authorized and qualified personnel, in compliance with the laws in force on the subject and with the use of appropriate and prescribed material.

 Before connecting the appliance to the electric mains, check that the voltage and frequency correspond to the data shown on the registration plate affixed to the rear of the appliance.

 The equipment is supplied with one of the following operating voltages:

- 220-240V ~ 50Hz
- 220-240V ~ 60Hz.

 Provide an earthed socket with a capacity appropriate to the absorption indicated on the identification plate.

 It is forbidden to operate the equipment connected to an ungrounded system.

 For direct connection to the power supply, a device must be provided to ensure disconnection from the power supply, with a contact-opening distance allowing complete disconnection under the conditions of overvoltage category III, in accordance with the installation rules.

 Refer to the technical data on the identification plate for the correct sizing of the switch.

 The switch disconnecter must be positioned near the equipment, must be visible to the operator and appropriately signalled by means of an information sign.

 If a plug is used, it must comply with national installation regulations.

 The plug must be accessible even after the equipment has been placed in the installation location.

 The plug must always be visible to the operator performing the maintenance operation.

After the electrical connection, check that the supply voltage, when the equipment is running, does not deviate from the nominal value given on the specifications plate $\pm 10\%$.

The power cable used for connection to the mains supply is of type H05VV-F; when replacing it, use a cable with the same or better characteristics.

 When replacing the power cable, the earth conductor must be kept longer than the active conductors.

 The replacement of the damaged power cable must be carried out by qualified technical personnel in order to prevent any possible risk.

6.4. Water connection



The appliance must be supplied with drinking water. The table groups together the limits dictated by the European Community for water to be considered drinkable.

Description	Value
Pressure	150÷300 kPA - 1.5÷3 bar
pH	6.5÷8
Hardness	5÷15°F - (50÷150 ppm CaCO ₃)
Dry Residue	<1500 mg/L
Iron	< 0,2 mg/l
Manganese	<0,05 mg/L
Chlorides	<0,25 mg/L
Sulphates	<0,25 mg/l

Retarder Prover 60x40

To carry out connection, connect the mains pipe to the appliance connection pipe ($\varnothing \frac{3}{4}$ " (1), interposing a shut-off cock interposing a tap of interception (A) to interrupt the water supply when necessary.

Downstream from this, install some easily reachable filters.

The water temperature must be between 5°C and 50°C.

The water pressure must be enough to guarantee a correct functioning (see the following table).

Connect the safety discharge (2) present at the top of the equipment, directly to the water drain.

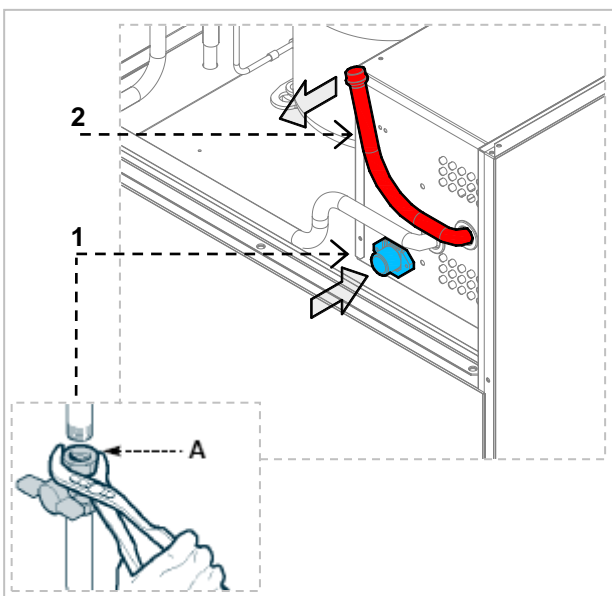

Connect the water evaporator discharge (3), present at the bottom of the appliance, directly to the water drain.

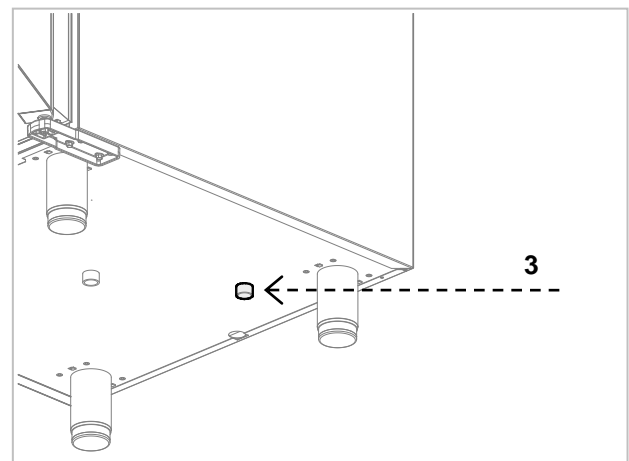

Retarder Prover 60x80

To carry out connection, connect the mains pipe to the appliance connection pipe ($\varnothing \frac{3}{4}$ " (1), interposing a shut-off cock interposing a tap of interception (A) to interrupt the water supply when necessary.

Downstream from this, install some easily reachable filters.

The water temperature must be between 5°C and 50°C.

The water pressure must be enough to guarantee a correct functioning (see the following table).

Connect the safety discharge (2) present at the top of the equipment, directly to the water drain.

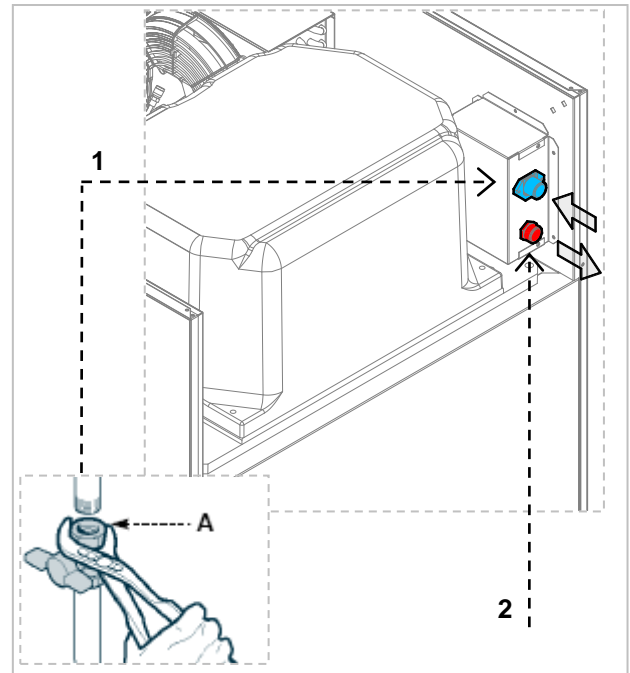
**6.5. Inspection**

The appliance is delivered in conditions that it can be started-up by the user.

This functionality is guaranteed by passing the tests (electric inspection - functional inspection, appearance inspection) and relative certification through the specific attachments.

7. USE AND FUNCTIONING ND FUNCTIONING

7.1. First Power On

At the first switch-on of the equipment, the device will display the stand-by screen.

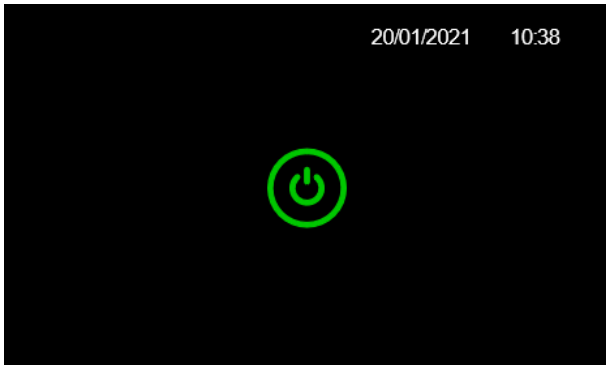



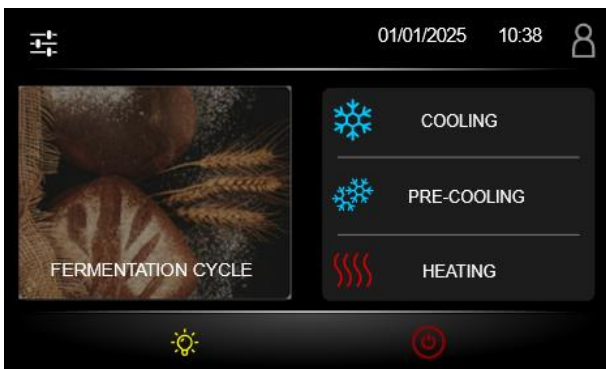

To turn the device on, from the stand-by screen, press the icon  to display the main screen.



From the main screen, pressing the respective icons allows you to enter the individual manual or leavening cycles, or activate different functions.

Icon  allows access to the menu.





Using the   icons, it is possible to scroll through the various pages, while pressing the   icons it is possible to scroll through the entries.

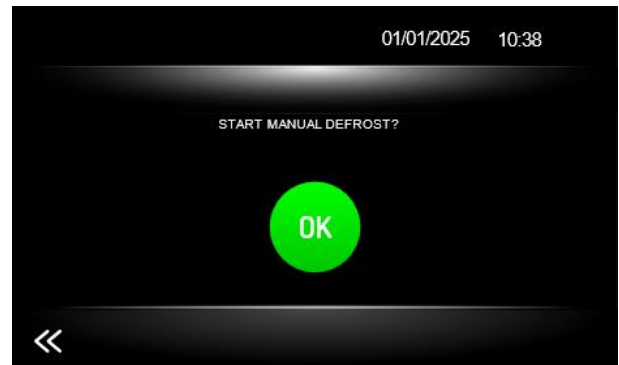

The entry **USER MANAGEMENT** will only appear if the user level is ADMIN.

Pressing on **MANUAL DEBRIPTION**, it will be displayed the screen for its activation.



Press on the icon  to activate the defrost, should it be desired to return to the previous screen without saving, then press icon .

Pressing on **INTERNAL VALUES**, the screen with the values measured by the probes, the status of inputs and outputs and any alarms will appear.

INTERNAL VALUES	
PROBE 1	26.2°C
PROBE 2	26.3°C
HUMIDITY	36%
DOOR INPUT	OFF
MF1 INPUT	OFF
MF3 INPUT	OFF

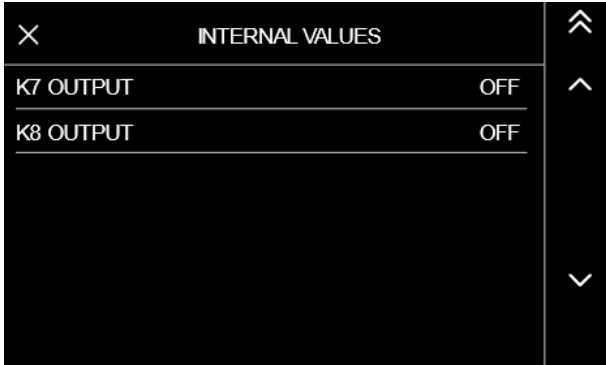
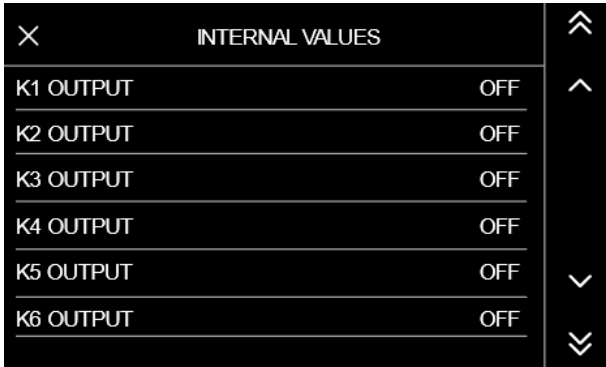

Pressing on **COUNTERS**, the screen with the compressor operating times will appear.

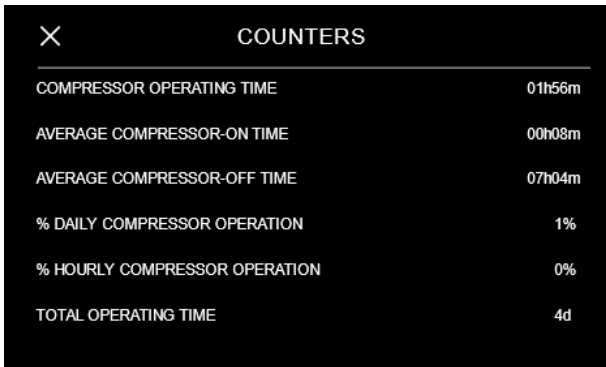

Pressing on **GENERAL SETTINGS**, the screen for changing some settings such as date and time or language will appear. To change them, refer to section 7.2.

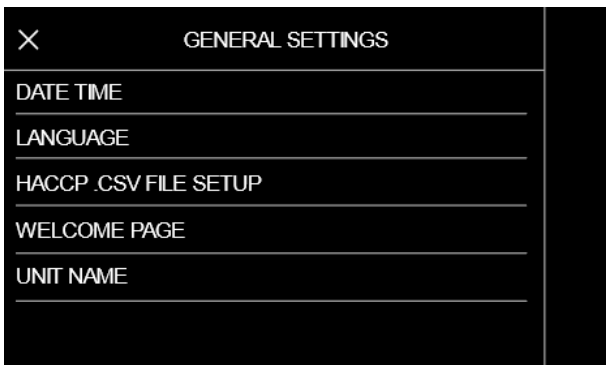

Pressing on **SERVICE**, the screen for changing the parameters and deleting recipes, counters and historical data will appear. To change them, refer to section 7.3.

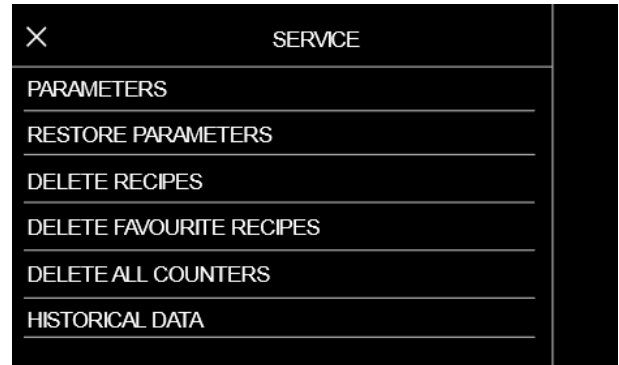

Pressing on **ADVANCED**, the screen for activating a test cycle or output test (functions used by the manufacturer) will appear.



Pressing on **USER MANAGEMENT**, the screen with the three users will appear (this screen can only be managed by the ADMIN user and only if the user option is active).



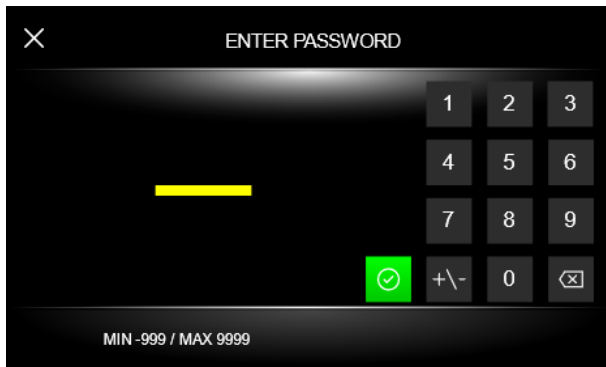

Back on the main screen, pressing the icon  allows the user level to be changed (this function is optional).



There are three user levels:

 USER



 SERVICE: password 125

 ADMIN: password 250



Only the ADMIN user can change access to the different menus and options in user management (page 16).





Disabling any of these entries will prevent the selected user from having access to certain screens or changing certain parameters.

Once the user configuration operations have been completed, it will be possible to log-out manually from the main page by pressing above the icon of the currently active user ( or ) , otherwise the controller will time-out after 5 minutes.

Back on the main menu, the following icons can also be found:

 or  the dashboard or cell light can be switched on or off.

 The light can be switched on and off even while the cycles are running, or it switches on automatically when the door is opened.

 Indicates that the cabinet is connected to the wi-fi network (this function is optional and only valid with the wi-fi module and EPOCA application).

 If it is flashing, the controller is trying to connect to the Wi-fi network.

 Turning off the device.

7.2. General Settings

Date/Time Setting

Within the menu, by clicking on GENERAL SETTINGS (section 7.1), the current date and time can be set.

Select the value to be changed and type the correct one on the numeric keypad, press on icon  to confirm.

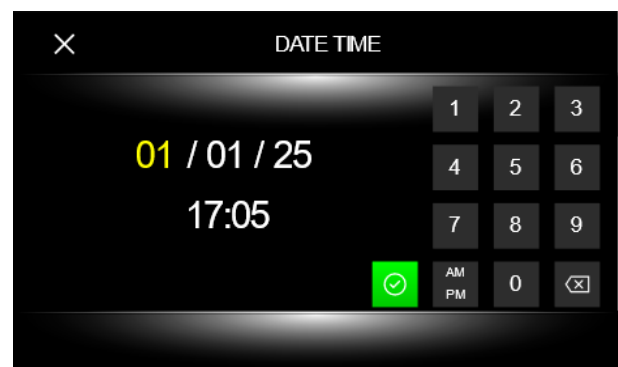

Languages

Within the menu, by clicking on GENERAL SETTINGS (section 7.1), the desired language can be set.





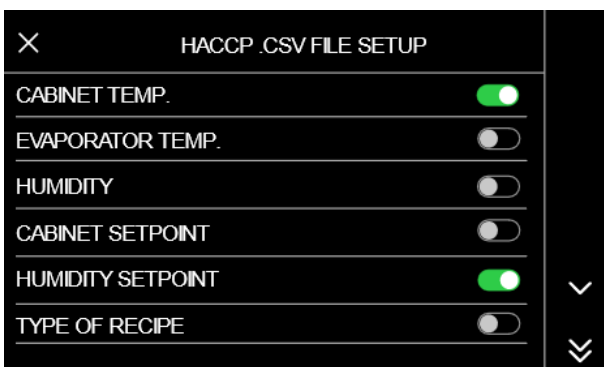

Selecting the desired language will restart the controller.

Setup HACCP .CSV file

Within the menu, by pressing GENERAL SETTINGS (section 7.1), it is possible to select the variables to be recorded for the HACCP record:



Click on the following icons     to scroll through the individual screens.

Welcome Page

Within the menu, by pressing GENERAL SETTINGS (section 7.1), it is possible to enable or disable the welcome page:

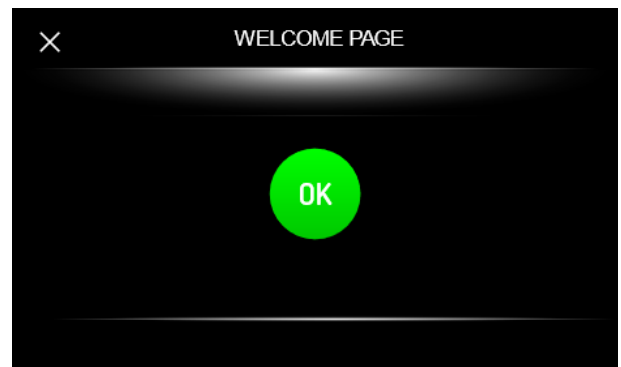

Press on the icon , and when first switched on the device will display some settings to quickly configure the controller.

These settings are:

- Language
- Device Name
- Date and time
- Measurement Unit

After the first power on, the function will be disabled.

Unit name

Within the menu, by pressing GENERAL SETTINGS (section 7.1), it is possible to change the name of the unit.



Pressing on the  icon will save the new name.

7.3. Service

Parameters

Within the menu, by pressing SERVICE (section 7.1), it is possible to access parameter editing screen.

This function is PASSWORD protected (PW-19).

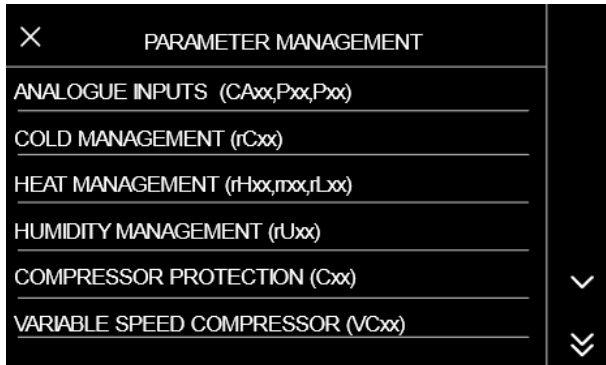

Delete Recipes and Favourite Recipes

Within the menu, by pressing SERVICE (section 7.1), it is possible to delete all recipes.

This function is PASSWORD protected (PW 99).

Delete Counters and Data Record

Within the menu, by pressing SERVICE (section 7.1), it is possible to delete the counters and the data record.

This function is PASSWORD protected (PW 99).

GB

7.4. Use of the USB port (Optional)

Before inserting the key into the USB port on the device, enter the ON/Standby screen:

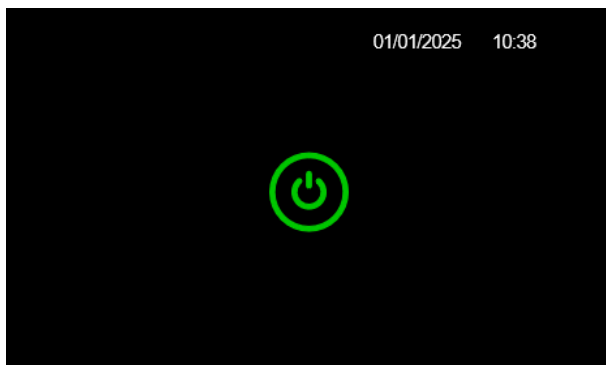

After inserting the USB key, the following menu will appear:

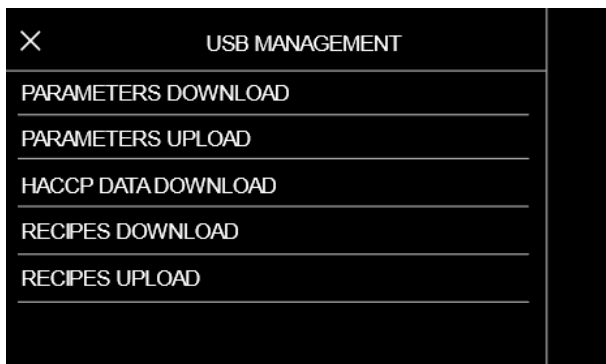

The USB port can perform the following functions:

PARAMETERS DOWNLOAD: allows the parameters saved in the controller to be downloaded to a USB key.

UPLOAD PARAMETERS: allows the parameters contained in the USB key to be uploaded to the controller.

RECIPES DOWNLOAD: Allows USB download of recipes (programs) saved in the controller.

UPLOAD RECIPES: allows uploading recipes (programs) contained in a USB key to the controller.

DOWNLOAD HACCP DATA: allows the download to USB key of the data relating to the cycles performed (HACCP record).

For the record download function, select the start date of the HACCP data download:

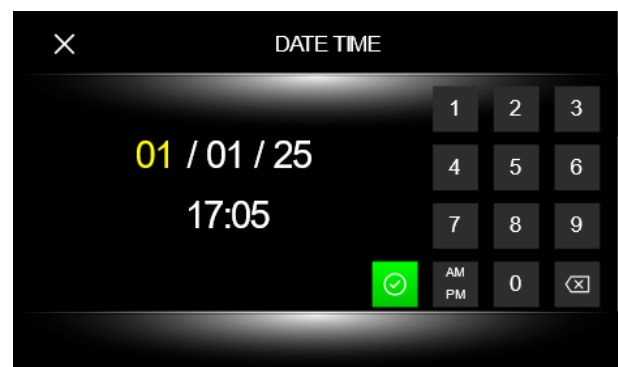

7.5. Manual Refrigeration Cycle

From the main screen, press the icon COOLING.



Before starting the cycle, pressing on the temperature icon gives access to the setpoint change function.

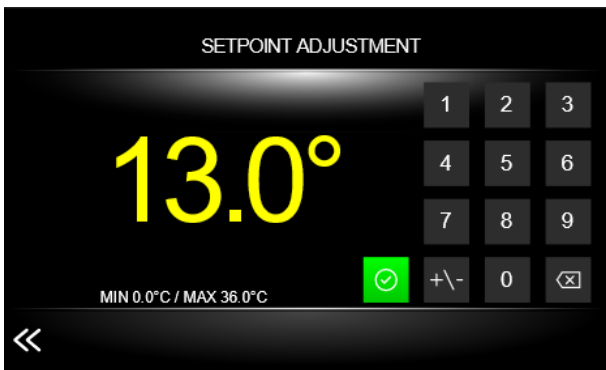

Set the desired temperature value on the numeric keypad, press icon to confirm. To set a negative temperature, press the icon at the end of the input. Or, to return to the previous screen without saving, press icon .

A cooling cycle duration can be defined by pressing icon .



Set the desired duration on the numeric keypad, press icon to confirm. To set an infinite cycle, press the INF icon and confirm the choice. To

return to the previous screen without saving, press icon .

The evaporator fan speed can be changed by pressing icon (this function is optional and only valid in the case of adjustable fans).

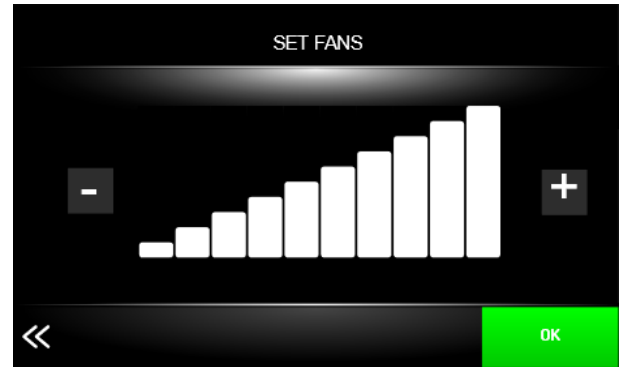

To change the fan intensity press icons and , to confirm press icon . To return to the previous screen without saving, press icon .

The fan speed can be changed even while the cycle is running.

To start the manual cooling cycle press .

Below is the displayed screen:



During the execution of the manual cycle, several icons will appear on the top of the screen:

Indicates the refrigerant system and compressor are switched on.

Indicates fans are running.



Menu of manual controls for activating manual defrosting or for controlling internal values (section 7.1)

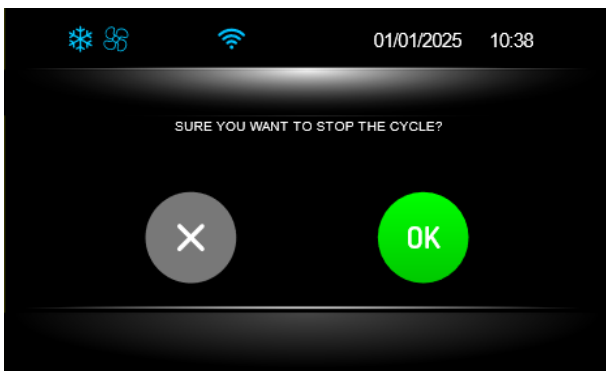

 Indicates the activation of a defrost that can be automatic or manual.

 if pressed opens the end of cycle screen.



Pressing on the  icon ends the set cycle, while the  icon allows it to continue.

After a predefined idle time, the system switches to 'SCREEN SAVER' mode, and the display shows the values measured by the probes in use.



To exit "SCREEN SAVER" mode, simply touch the screen. Even an alarm situation in progress interrupts the "SCREEN SAVER" mode.

7.6. Manual Heating Cycle

From the main screen, press the icon HEATING.

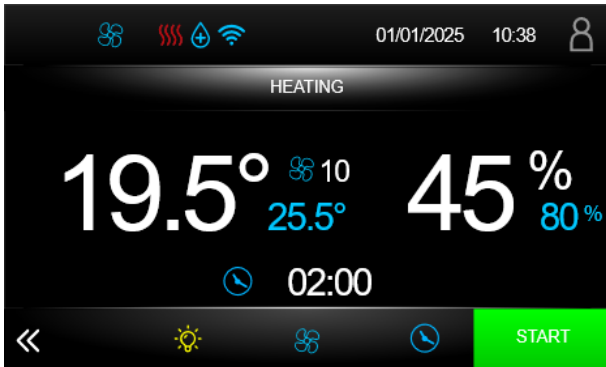

Before starting the cycle, pressing on the temperature icon gives access to the setpoint change function.

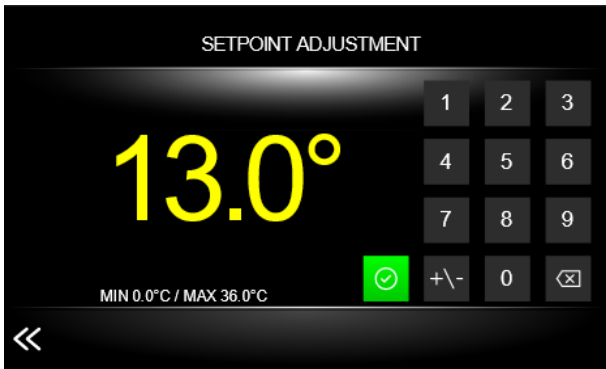

Set the desired temperature value on the numeric keypad, press icon to confirm. Or, to return to the previous screen without saving, press icon .

Pressing on the humidity icon gives access to the setpoint change function.

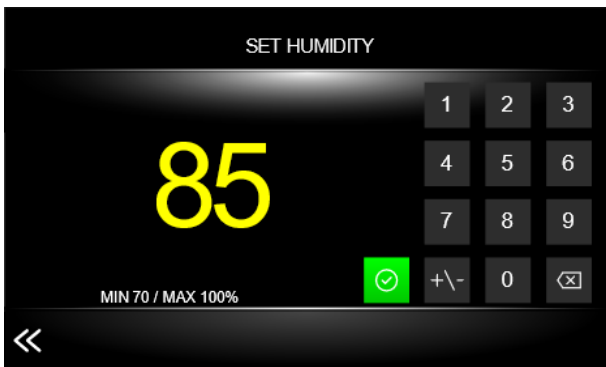

Set the desired humidity value on the numeric keypad, press icon to confirm. Or, to return to the previous screen without saving, press icon .

A cooling cycle duration can be defined by pressing icon .



Set the desired duration on the numeric keypad, press icon to confirm. To set an infinite cycle, press the INF icon and confirm the choice. To return to the previous screen without saving, press icon .

The evaporator fan speed can be changed by pressing icon (this function is optional and only valid in the case of adjustable fans).

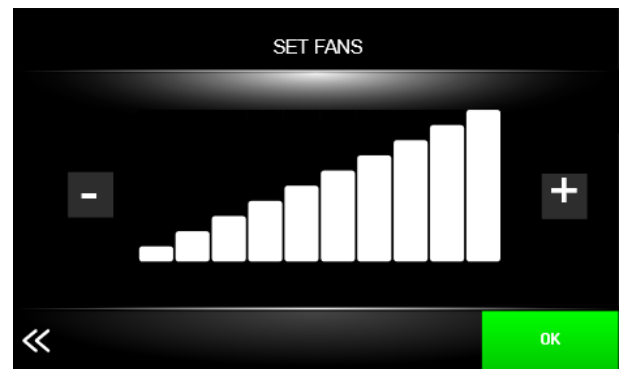

To change the fan intensity press icons and , to confirm press icon . To return to the previous screen without saving, press icon .

The fan speed can be changed even while the cycle is running.

To start the manual heating cycle press **START**.

Below is the displayed screen:

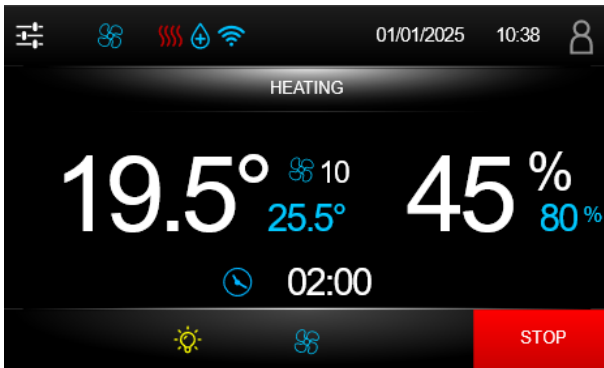

During the execution of the manual cycle, several icons will appear on the top of the screen:

 Indicates the switching on of the heating elements.

 Indicates that the humidification phase is in progress.



 Indicates that the dehumidification phase is in progress.

 Manual control menu for checking internal values (section 7.1)

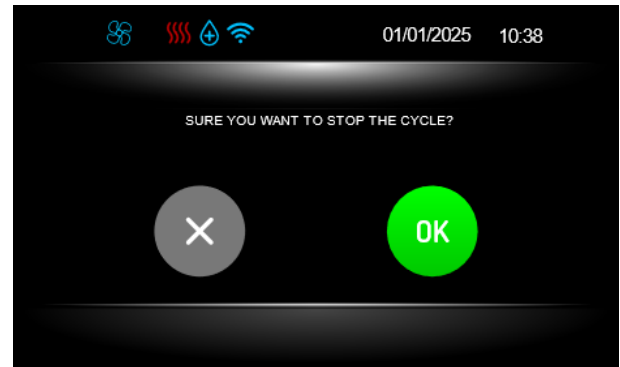

STOP if pressed opens the end of cycle screen.



Pressing on the icon  ends the set cycle, while the icon  allows it to continue.

After a predefined idle time, the system switches to 'SCREEN SAVER' mode, and the display shows the values measured by the probes in use.

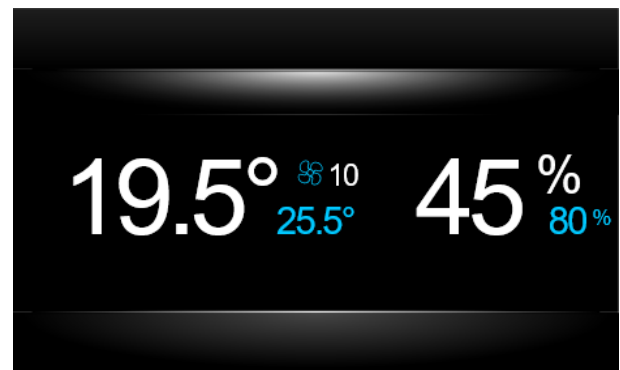

To exit "SCREEN SAVER" mode, simply touch the screen. Even an alarm situation in progress interrupts the "SCREEN SAVER" mode.

GB

7.7. Pre-cooling

From the main screen, press the icon PRE-COOLING.

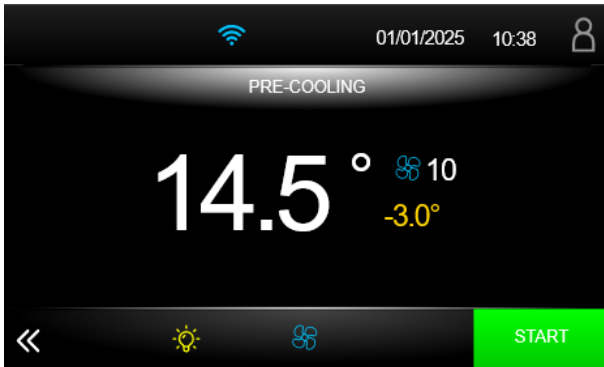

Before starting the cycle, pressing on the temperature icon gives access to the setpoint change function.

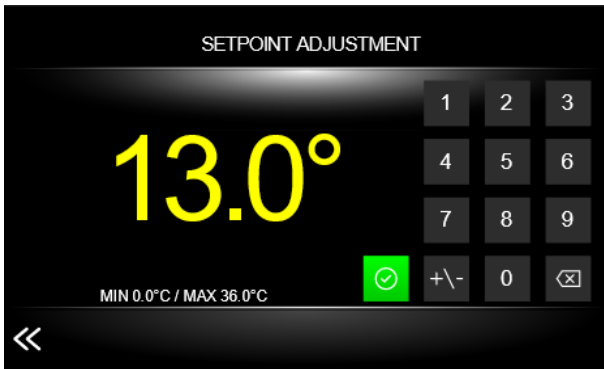

Set the desired temperature value on the numeric keypad, press icon to confirm. To set a negative temperature, press the icon at the end of the input. Or, to return to the previous screen without saving, press icon .

The evaporator fan speed can be changed by pressing icon (this function is optional and only valid in the case of adjustable fans).

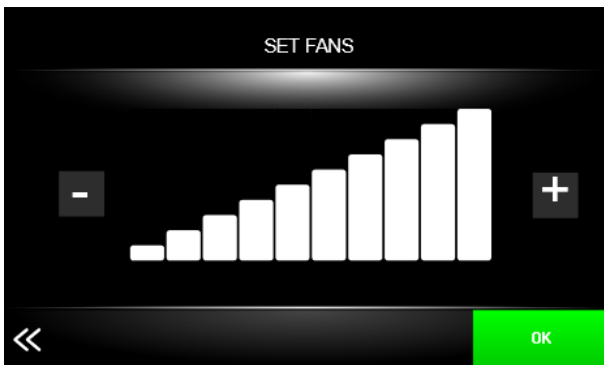

To change the fan intensity press icons and , to confirm press icon . To return to the previous screen without saving, press icon .

The fan speed can not be changed while the cycle is running.

To start the manual pre-cooling cycle press .

Below is the displayed screen:

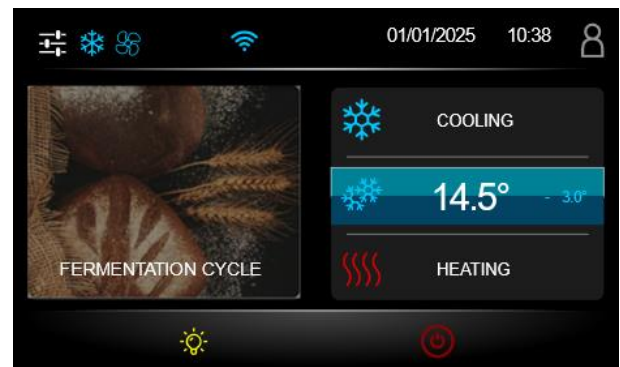

The first time the setpoint is reached, the controller will emit an acoustic signal. If the temperature in the cell is equal to or below the setpoint, the pre-cooling function cannot be activated.

The pre-cooling function has an infinite duration, i.e. it ends the moment a cycle, manual or automatic, is started. Or, it is possible to end the cycle by pressing the temperature icon.

7.8. Fermentation Cycle

From the main screen, click on the FERMENTATION CYCLE icon



The RECIPE BOOK includes the standard recipes provided by the manufacturer, while the FAVOURITES are the recipes that will be saved as favourites.

To return to the main screen without saving, press icon

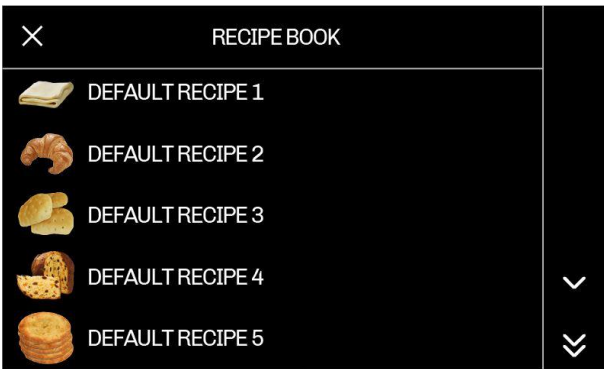

Click on the following icons to scroll through the individual screens.

Selecting a STANDARD or FAVORITE RECIPE will open a screen with the individual steps of the leavening process.

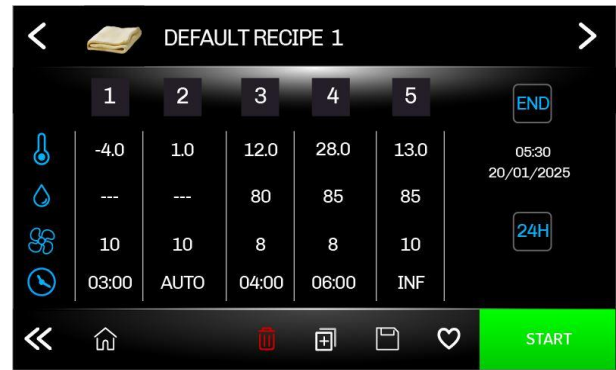

The steps that compose a FERMENTATION cycle are:

- 1 STEP 1: Block
- 2 STEP 2: Preservation
- 3 STEP 3: Awakening
- 4 STEP 4: Proofing
- 5 STEP 5: Cooking delay

In addition to the different stages, other icons with different functions are also displayed on this screen:

or to scroll through the recipes.

to return to the previous screen.

to return to the main screen.

delete recipe.

create a new recipe.

save the recipe changes.

or to set the recipe as favourite (it will appear among the FAVOURITE recipes).

It is also possible to change the image in the top left-hand corner to one of those in the library

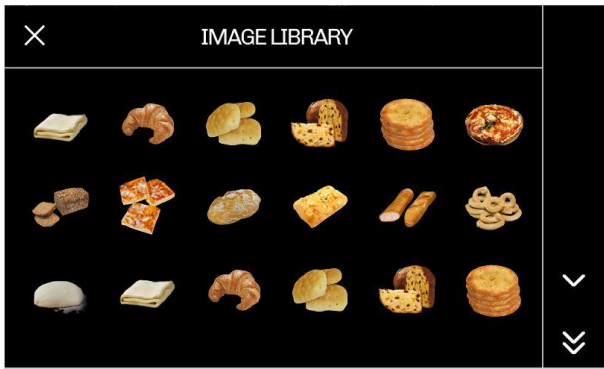

Click on the following icons to scroll through the individual screens.

Choose the image to be used and save the recipe to confirm .

Press on the name of the recipe to change it.



Choose the name to be used and confirm the selection with , then save the recipe .

It is possible to access the menu for setting setpoints for each of the fermentation phases by pressing on the column corresponding to the phase to be changed.

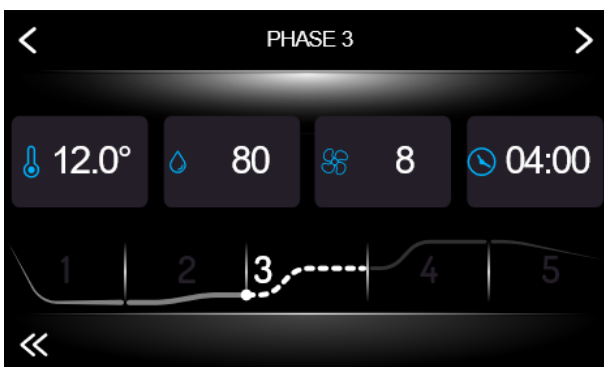

Press or to scroll through the steps.

Or, to return to the previous screen without saving, press icon .

Pressing on the temperature icon gives access to the setpoint change function.

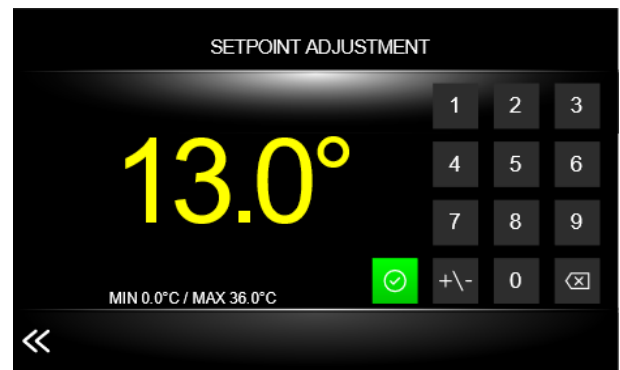

Set the desired temperature value on the numeric keypad, press icon to confirm. To set a negative temperature, press the icon at the end of the input. Or, to return to the previous screen without saving, press icon .

Pressing on the humidity icon gives access to the setpoint change function.

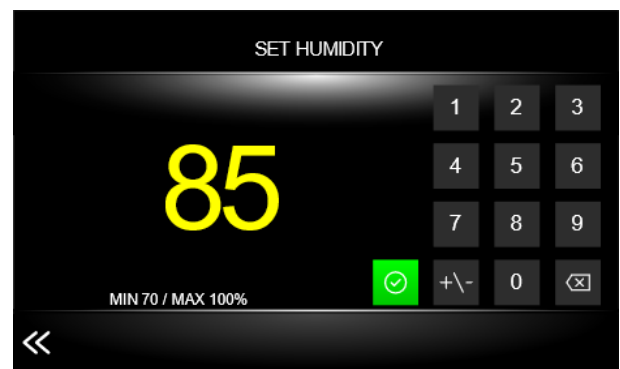



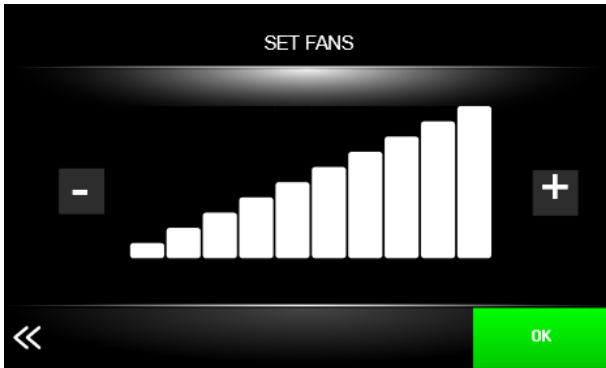

Set the desired humidity value on the numeric keypad, press icon to confirm. Or, to return to the previous screen without saving, press icon .

GB

The evaporator fan speed can be changed by pressing icon  (this function is optional and only valid in the case of adjustable fans).



To change the fan intensity press icons  and , to confirm press icon . To return to the previous screen without saving, press icon .

 The fan speed can be changed even while the cycle is running.

A cooling cycle duration can be defined by pressing icon .



Set the desired duration on the numeric keypad, press icon  to confirm.

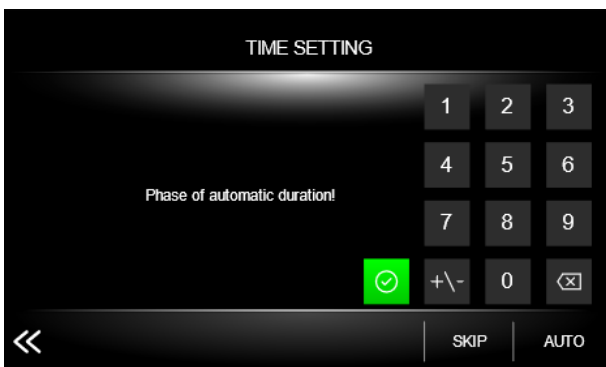

For phase 2, an automatic duration can be set by clicking on the AUTO icon, or the entire phase can be skipped by clicking on the SKIP icon.

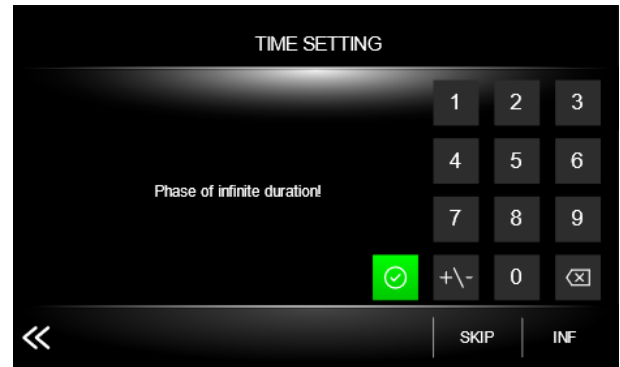

For phase 5, it is possible to set an infinite duration by pressing the INF icon, or to skip the entire phase by pressing the SAVE icon.

To return to the previous screen without saving, press icon .

On the right side of the screen, the date and time of the end of the fermentation cycle is indicated.

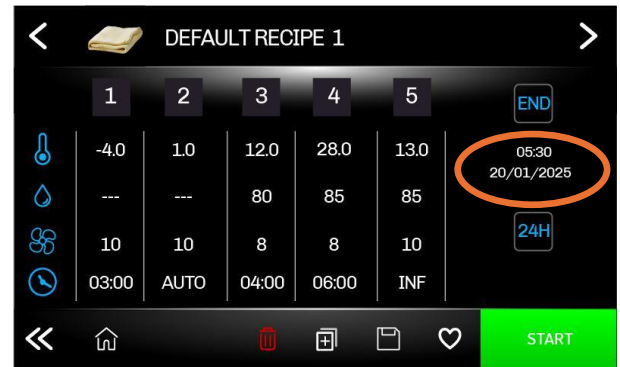

If a duration of phase two is skipped or entered, the date and time in the device are calculated based on the sum of the durations of the first 4 phases.

If step two is automatic, however, the date and time can be selected by clicking directly on the icon. The preservation time will therefore be calculated by subtracting the duration of stages one, two and four from the total time.

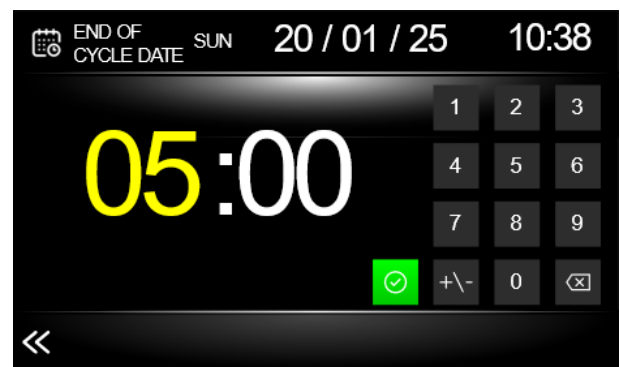



Set the desired time on the numeric keypad, press icon  to confirm.

To return to the previous screen without saving, press icon .



END OF CYCLE DATE				
SUN	MON	TUE	WED	THU
19/01	20/01	21/01	22/01	23/01
FRI	SAT	SUN	MON	TUE
24/01	25/01	26/01	27/01	28/01
WED	THU	FRI	SAT	SUN
29/01	30/01	31/01	01/02	02/02

Set the desired duration on the numeric keypad, press icon  to confirm. To return to the previous screen without saving, press icon .

A screen with an overview of the timing of the various steps will be displayed by pressing the icon .

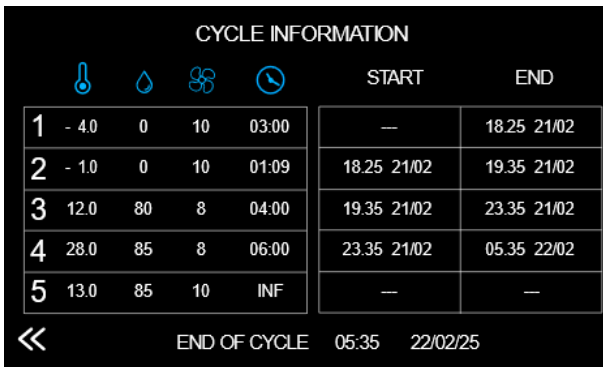

CYCLE INFORMATION						
	TEMP	HUMID	TIME	START	END	
1	- 4.0	0	10	03:00	—	18.25 21/02
2	- 1.0	0	10	01:09	18.25 21/02	19.35 21/02
3	12.0	80	8	04:00	19.35 21/02	23.35 21/02
4	28.0	85	8	06:00	23.35 21/02	05.35 22/02
5	13.0	85	10	INF	—	—

END OF CYCLE 05:35 22/02/25

By pressing on the  icon instead, the end date of the cycle can be postponed by 24 hours.

 If this function is used, the hours will be added to phase 2, i.e. the preservation phase.

Press  to start the fermentation cycle. The cycle will end with an acoustic signal at the end of phase 4, according to the set date and time.

During an ongoing cycle, the following screen will be proposed:



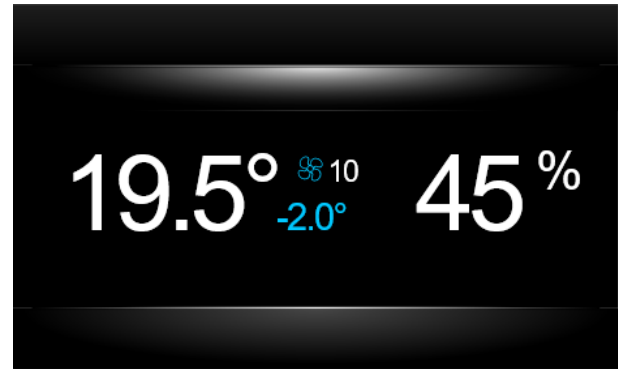

After a predefined idle time, the system switches to 'SCREEN SAVER' mode, and the display shows the values measured by the probes in use.



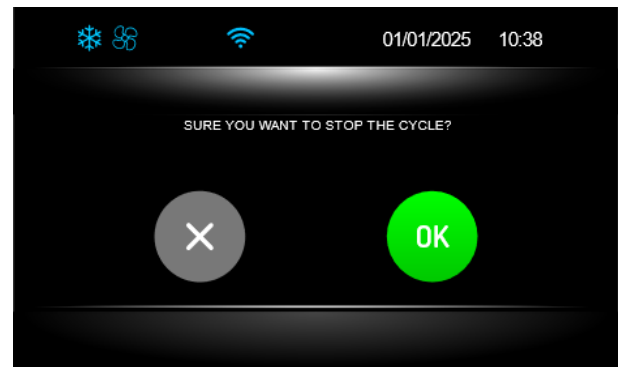

To exit "SCREEN SAVER" mode, simply touch the screen.

 if pressed opens the end of cycle screen.



Pressing on the icon  ends the set cycle, while the icon  allows it to continue.

 Phase 5 (cooking delay) is optional. If enabled, it can only be stopped manually by pressing the .

During the different steps by pressing the temperature icon it is possible to review the recipe by changing the various setpoints and fan speed.

	1	2	3	4	5	
Temperature	-4.0	1.0	12.0	28.0	13.0	05:30 20/01/2025
Humidity	---	---	80	85	85	
Fan Speed	10	10	8	8	10	
Time	03:00	AUTO	04:00	06:00	INF	

By pressing on the cycle graph instead, it is possible to review the generic account of the different stages.

	Temperature	Humidity	Fan Speed	Time	INIZIO	FINE
1	- 4.0	0	10	03:00	—	18.25 21/02
2	- 1.0	0	10	01:09	18.25 21/02	19.35 21/02
3	12.0	80	8	04:00	19.35 21/02	23.35 21/02
4	28.0	85	8	06:00	23.35 21/02	05.35 22/02
5	13.0	85	10	INF	—	—

END OF CYCLE 05:35 22/02/25

7.9. Recommendation for Use

Prolonged Inactivity

If the appliance remains inactive for a long period, proceed as follows:

1. Use the automatic disconnecting switch to deactivate connection to the main electrical line.
2. Clean the appliance and surrounding areas thoroughly.
3. Spread a thin layer of cooking oil onto the stainless-steel surfaces.
4. Carry out all maintenance operations.
5. Leave the doors ajar to prevent the formation of mould and/or unpleasant odours.
6. Empty the water present in the vapour generator boiler after having removed the clamp.

Recommendations for normal use

In order to ensure correct use of the appliance, it is advisable to apply the following recommendations:

- Do not obstruct the front and rear zones above the condensing unit in order to favour heat disposal from the condenser to a maximum.
- Always keep the front of the condenser clean using a soft brush and do not use rigid or metal tools that may damage the condenser fins.
- Check the planarity of the appliance rest surface.
- Do not introduce liquid or solid substances at temperatures above the environmental temperature and, however, introduce the material after the appliance has reached the functioning temperature.
- Do not stack the materials to be preserved in contact with the internal walls, so blocking the circulation of air, which guarantees uniformity of the internal temperature of the refrigerated compartment.
- Limit the number of times and the duration of time the doors are open to a maximum.

8. CLEANING AND MAINTENANCE

8.1. Recommendations for Cleaning and Maintenance



Before carrying out any maintenance intervention, activate all envisioned the safety devices. In particular, deactivate the electrical power supply using the automatic disconnecting switch.

During maintenance, the cable and plug must be visible to the operator performing the operation.

Do not touch the equipment with wet or damp hands or bare feet.

Do not remove safety guards.

Use appropriate personal protective equipment.

During maintenance, there are still some risks that cannot be avoided and which must be neutralised by adopting appropriate behaviour.

It is forbidden to carry out inspection, cleaning and/or maintenance operations on moving parts.

8.2. Routine Maintenance

Routine maintenance consists of daily cleaning of all the parts, which can come into contact with foodstuffs.

Correct maintenance allows the user to maximise performance levels and operating life and constantly maintain safety requirements.

Do not spray the appliance with direct jets of water or high pressure appliances.

When cleaning stainless steel, do not use iron wool, brushes or scrapers as ferrous particles could be deposited which, on oxidising, could lead to rust.

To remove hardened residues, use wooden or plastic spatulas or abrasive rubber pads.

During long periods of inactivity, spread a protective layer on all stainless steel surfaces by wiping them with a cloth soaked in Vaseline oil and airing the rooms periodically.





Do not use products, which contain substances, which are harmful and dangerous for personal health (solvents, petrol etc.).

8.3. Extraordinary Maintenance

 Extraordinary maintenance operations must be carried out by skilled technical staff, equipped with all personal protective devices.

 It is forbidden to remove or tamper with guards and safety devices while the machine is running.

 Procedures for topping up the refrigerant and repairing gas leaks may only be carried out by personnel who meet all the requirements of the regulations in force in the country where the equipment is used.

 In the case of flammable refrigerant gases, R290, R600a or other hydrocarbons, disconnect the machine from the power supply and completely purge the refrigerant circuit with an inert gas before proceeding with welding or other work requiring flames or sparks.

 In the event of hazardous situations being observed, e.g. damage and exposure to sharp objects, damage to electrical or thermal insulation, the equipment must not be operated or used and must be secured as soon as possible, preventing access to the surrounding area if necessary.

 **Periodically** have the following operations carried out by specialised staff:

- Periodically clean the condenser using suitable tools (suction device or soft brushes).
- Check the perfect sealing of the door gaskets and replace them if necessary.
- Periodically clean the condensate evaporation tray.
- Check that the electric connections have not loosened.
- Check the efficiency of the heating element (in BT models).
- Check functioning of the electric boards and probes.
- Check the efficiency of the electrical system.









8.4. Maintenance intervals



In order to assure constant efficiency of the equipment, it is advisable to inspect the equipment at intervals indicated in the following table:

Operation	Description	Interval
Routine cleaning	General cleaning of equipment and surrounding work area	daily
Mechanical protections	Inspection of the state of preservation of the external mechanical parts; heck for any deformation, loosening or removal	monthly
Control	Check of the mechanical part; check for cracks or deformations; check for tightness of screws; check of the state of preservation of the stickers and danger/information symbols.	yearly
Machine Structure	Check tightness of screws, main fasteners, etc.	yearly
Safety signs	Check legibility and state of preservation of signs	yearly
Electrical panel	Checking the state of preservation of electrical components and wiring between the switchboard and electrical components.	yearly
Connecting cable, socket and plug	Check the state of preservation of components (replace if necessary)	yearly
General equipment inspection	Complete general inspection of the equipment	10 years

9. FAULTS

The information shown below aims to help with the identification and correction of any anomalies and malfunctions, which could occur during use. Some of these problems can be resolved by the user. For the others, precise competency is required and they must therefore only be carried out by qualified staff.

Problem	Causes	Solutions
The refrigerator unit does not start	End of defrosting	It restarts after a pause of three minutes.
	No Voltage	Check plug, sockets, fuses and electric mains
	If the condenser fan runs, intervened klixon the compressor	Replace the compressor or electrical box
	Other causes	 Contact the after-sales centre.
The refrigerator unit functions continuously, cooling insufficiently	Room too hot	Air the environment
	Dirty condenser	Clean the condenser
	Insufficient door sealing	Check the gaskets
	Check the correct functioning of the thermostatic valve	Control the valve adjustment.
	Insufficient quantity of refrigerant gas	 Contact the after-sales centre.
	Hot gas valve partially open (only 60x40 version)	 Contact the after-sales centre.
	Resistances always inserted	 Contact the after-sales centre.
	Condenser fan at a standstill	 Contact the after-sales centre.
	Evaporator fan at a standstill	 Contact the after-sales centre.
The refrigerator unit does not stop	Probe faulty	 Contact the after-sales centre.
	Thermostat fault	 Contact the after-sales centre.

Problem	Causes	Solutions
Presence of ice inside the evaporator	Appliance not level	use the adjustable feet to level
	Hot gas valve failure (only 60x40 version)	 Contact the after-sales centre.
	Resistances not functioning	check defrosting activation (only on models with electric defrosting)
	Check parameters	60x80 BT version - P73=0
	Check steam generator	Verify that the steam generator is not always on
	Check the defrost probe	Check the value of the probe
	Insufficient door sealing	check the gaskets
Appliance noise	Persistent vibrations	check that there is no contact between the appliance and other objects inside or outside
The electronic board remains off.	Power supply cable incorrectly connected.	Check the electric connection
	Interrupted fuses	Check and replace fuses
The machine does not heat correctly	Protective Klixon (PTRC) interrupted.	Check and replace the component.
	Check heating element	Check connections and resistance
	Evaporator fan blocked	 Contact the after-sales centre.

Problem	Causes	Solutions
Insufficient humidity in proving chamber	Closed water cock	Open water inlet cock
	Clogged water filter	Clean filter
	Water inlet electrovalve malfunctioning	Replace component
	Vapour inlet electrovalve malfunctioning	Check and replace the component.
	Boiler resistance not working	Check and replace the component.
	Check humidity sensor	Check if the value of the probe is correct
	Malfunctioning sensor or level control	Check and replace the component.
Deformed water inlet pipe (high pressure inside boiler).	Vapour inlet electrovalve malfunctioning	Check and replace the component.
	Blocked boiler safety valve	Check and replace the component.
	No pressure reducer	Check and insert the reducer inside water inlet valve
	Malfunctioning sensor or level control	Check and replace the component.

9.1. Alarms Display

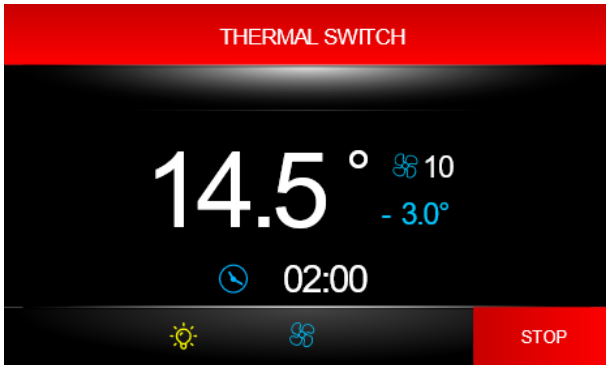

In the event of an alarm, the device will show the type of alarm at the top of the display.





Clicking on the latter will bring up the alarm list.



Problem	Causes	Effects	Solutions
RTC	RTC Alarm Malfunctioning of the internal clock. Time not set	The buzzer is active. The buzzer can be silenced pressing any key. Any running cycle will be stopped, and all outputs disabled.	Set the date and the current time.
CABINET PROBE	Cabinet Probe Alarm Cabinet probe damaged	The buzzer is active. The buzzer can be silenced pressing any key. Any running cycle will be stopped, and all outputs disabled.	Check the connection and the integrity of the cabinet probe. If necessary, replace it (NTC). ✖ Contact the after-sales service. Once the error has disappeared, the cycle resumes.
EVAPORATOR PROBE	Evaporator Probe Alarm Evaporator probe damaged	The buzzer is active. The buzzer can be silenced pressing any key. The defrosting end time-out (see parameter d3)	Check the connection and the integrity of the evaporator probe. If necessary, replace it. ✖ Contact the after-sales service.
CONDENSER PROBE	Condenser Probe Alarm Condenser probe damaged	The buzzer is active. The buzzer can be silenced pressing any key. The condenser fan will run in parallel to the compressor.	Check the connection and the integrity of the cell probe. If necessary, replace it. ✖ Contact the after-sales service.

HUMIDITY PROBE	Humidity Probe Alarm Humidity probe damaged.	The buzzer is active. The buzzer can be silenced pressing any key. Any cycle that involves the use of the humidity probe will be terminated.	Check the connection and the integrity of the humidity probe. If necessary, replace it.  Contact the after-sales service.
POWER FAILURE	Power failure alarm		Verify the electrical power supply.
EVAPORATOR HIGH TEMPERATURE	High Evaporator Temperature Alarm Evaporator fan out of order. Heating elements always inserted.	The buzzer is active. The buzzer can be silenced pressing any key. The temperature detected by the probe is higher than the set value (60°C)	Replace the evaporator fan Verify the heating element connection  Contact the after-sales service.
THERMAL SWITCH	Alarm Safety Thermostat Steam Generator	The buzzer is active. The buzzer can be silenced pressing any key. Press thermostat button (see chapter 4.6) Faulty water level probe. Defective thermostat.	Check and eventually clean the water level probe inside the steam generator. Check and replace the safety thermostat if necessary.  Contact the after-sales service.
OPEN DOOR	Open Door signal Door opening	The buzzer is active. The buzzer can be silenced pressing any key.	The signal automatically returns once the door is closed.

Problem	Causes	Solutions
NO COMMUNICATION	Interface communication error user- control module.	 Contact the after-sales service.
POWER BOARD INCOMPATIBILITY	Interface compatibility error user- control module.	 Contact the after-sales service.
CONDENSER OVERHEAT	The temperature of the condenser has exceeded the first limit imposed. <ul style="list-style-type: none"> The condenser fan will be turned on The alarm output will be activated. 	 Contact the after-sales service.
COMPRESSOR SHUTDOWN	The temperature of the condenser has exceeded the second limit imposed. <ul style="list-style-type: none"> It will not be allowed either select or start any operating cycle. If the error occurs during an operating cycle, the cycle will be interrupted. The alarm output will be activated. 	

10. TECHNICAL NOTES

10.1. Assembly kit accessory wheels

- Unscrew the feet (1) until they are removed completely
- Fix wheel (2) and base (3) board to the bottom of the cabinet using the screws supplied.
- The screws of each wheel can be inserted in the envisioned 4 Ø 6mm holes.

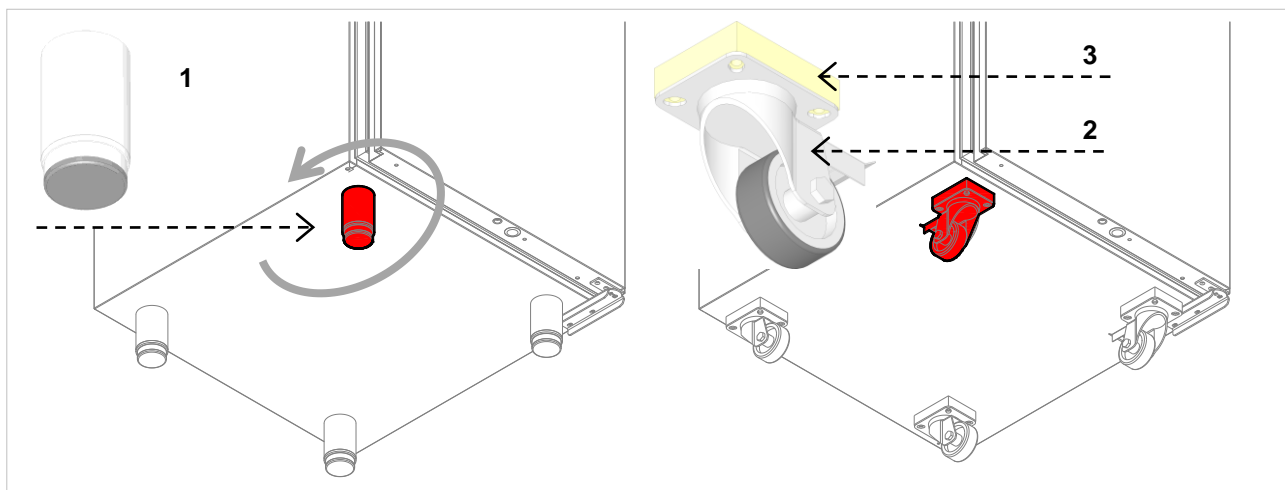

10.2. Reversibility of the Doors

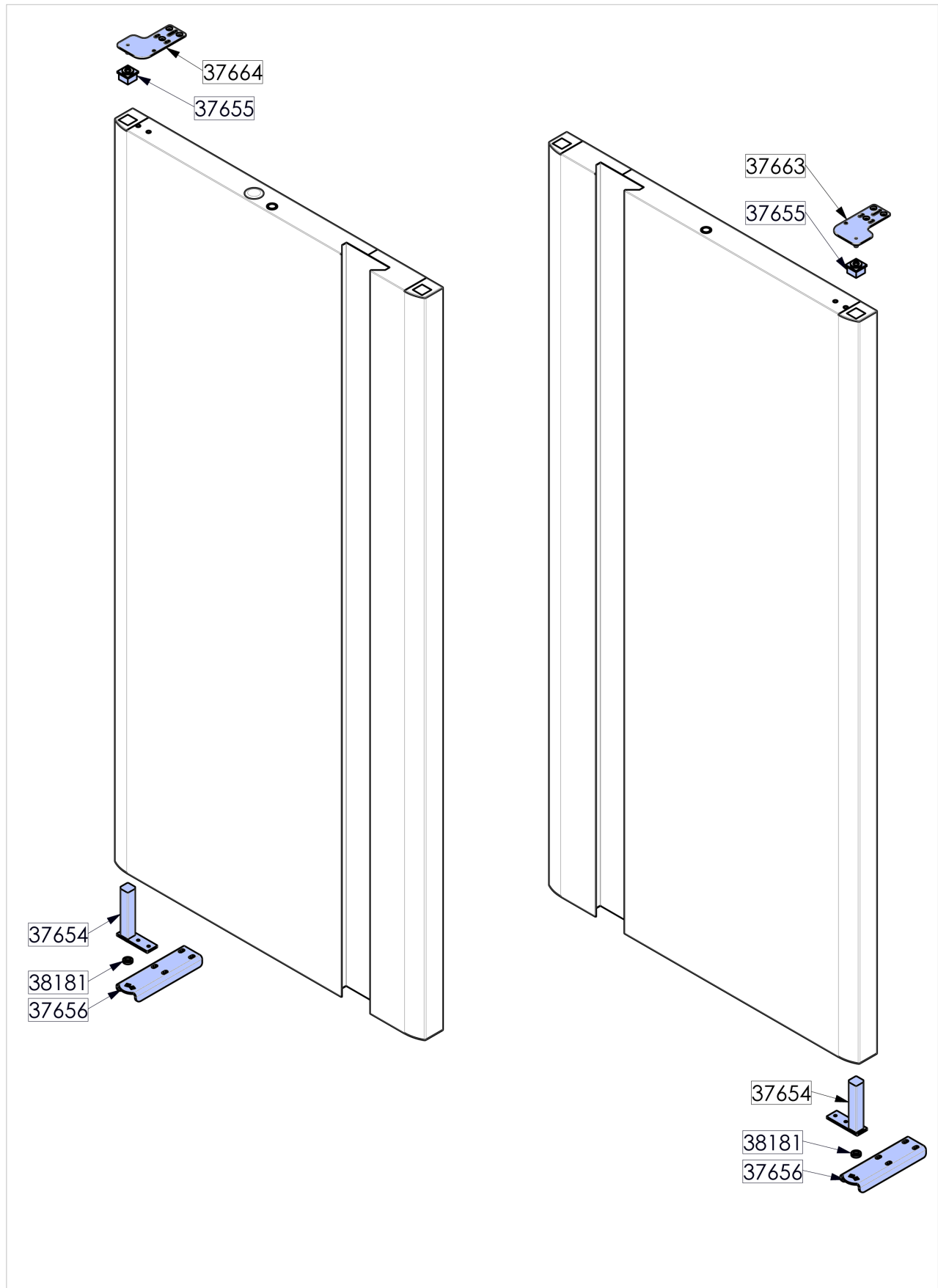

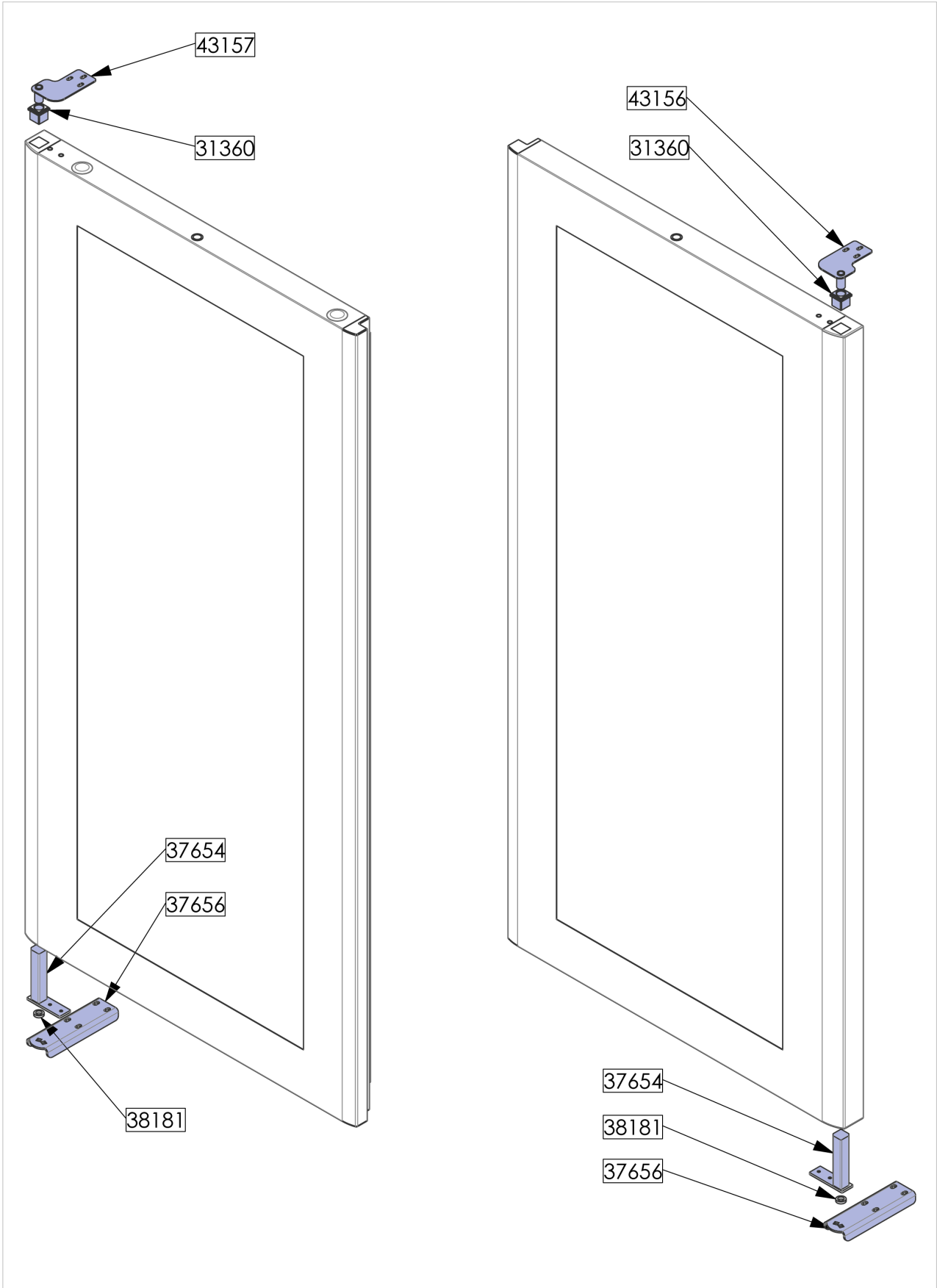

GB

GB





11. DISPOSAL OF THE EQUIPMENT

 This equipment is marked in compliance with the 2012/19/UE RAEE European Directive.

 By assuring that this product is disposed of correctly, the user contributes to preventing the potential negative consequences on the environment and health.

The improper disposal of Waste Electrical and Electronic Equipment is liable to punishment under the relevant laws in the countries where the offence is committed.

Waste electrical and Electronic Equipment may contain hazardous substances with potential harmful effects on the environment and human health. You are urged to dispose of them properly.

 The  symbol found on the product or on the accompanying documentation indicates that this product must not be treated as domestic waste but must be taken to suitable collection points for the recycling of electric and electronic appliances.

GB

11.1. Waste Storage

At the end of the product life, avoid release to the environment.

Temporary storage of special waste is permitted while waiting for disposal by treatment and/or final collection.

Dispose of special waste in accordance with the laws in force with regard to protection of the environment in the country of the user.

For further information regarding the treatment, recovery and recycling of this product, contact the relevant local office, the domestic waste collection service or the shop where the product was purchased.

11.2. Equipment disassembly procedure

 Dismantling operations should be carried out by qualified personnel.

 If the equipment uses R290 cooling gas, every possible precaution must be taken to avoid any danger linked to the flammability of this gas.

 The doors should be removed before disposal.

 Make the appliance totally unusable by removing the power cable and any door locking mechanisms in order to avoid the risk of anyone being trapped inside.

 Dismantle the refrigerator grouping together the components according to their chemical nature. The compressor contains lubricating oil and refrigerant, which may be recycled. The refrigerator components are considered special waste, which can be assimilated with domestic waste.

12. TECHNICAL DATA SHEET OF REFRIGERANT R290

Name	Chemical Formula
HC-290	CH ₃ CH ₂ CH ₃

IDENTIFICATION OF DANGERS

- Extremely flammable
- Liquefied gas



GHS02



GHS04

FIRST AID

Inhalation: The intervention of a doctor is recommended. At high concentrations, it can cause asphyxia. Symptoms may include loss of mobility and/or consciousness.

Symptoms may include dizziness, headache, nausea and loss of coordination.

Move the victim to an uncontaminated area wearing self-contained breathing apparatus. Keep the patient relaxed and warm. Perform artificial respiration if breathing stops.

Skin and eyes contact: Wash with water for at least 15 minutes. Remove contaminated clothes

Ingestion: No action is necessary. Ingestion is not considered a means of exposure.

FIRE PREVENTION MEASURES:

Suitable extinguishing media:

Water spray, Dry powder.

NON-Suitable extinguishing media:

DO NOT use water jets to extinguish.

Carbon dioxide (CO₂).



Recommendations:

DO NOT extinguish an inflamed gas leak unless absolutely necessary; an explosive re-ignition may occur.