



MOD : CNE/6P

Production code : NEN16ME

09/2025

Installation, Operation and Maintenance Instructions

Electric Noodle Boiler

Model :

NEN 16 A (ME)

Six Noodle Baskets

One Faucet



Note: The picture is illustration only. We reserved the right to make technical changes in the interest in progress without prior notice.

Preface

Dear customer,



Thank you for choosing our product as your trusted partner. We ensure you that we always give our best as we produce this appliance by using the finest materials. Electric Noodle Boiler is excellent choice to cook. In order to obtain maximum benefits of this appliance, please read this manual instruction carefully. Please notice the warnings and safety instructions to keep your safety. DO NOT use this appliance except its utility.

If you have any questions or difficulties in operating this appliance, please contact your dealer to acquire mechanic assistance.

Table of Contents



	Page
Preface	2
Table of Contents.....	3
1. General Information	4
1.1 Information for the Reader	4
1.2 Warning, Signs and Symbols	4
1.3 General Information of the Appliance	5
1.4 Procedure for Requesting Service and Warranty.....	6
2. Safety Instruction	7
3. Technical Data	8
3.1 Data Table	8
3.2 Data Plate	8
3.3 Overall Dimension	9
3.4 Component List	10
4. Handling and Installing	12
4.1 Packaging and Transport	12
4.2 Handling and Lifting	12
4.3 Safety Devices and Accessories	13
4.4 Position and Fixing	13
4.5 Electric Power Connection	13
5. Use and Operation	15
5.1 Warning	15
5.2 Control Panel Description	15
5.3 Switch ON/OFF	16
6. Routine Cleaning and Maintenance	17
7. Trouble Shooting	18
8. General Exclusions	19
9. Addresses	20
10. Electric Wiring Diagram	on Appendix

1. General Information

1.1 Information for the Reader



Please read this manual instruction carefully before operating this appliance.

To find the specific topics of interest to you quickly, refer to the index at the start of the manual. This manual is written to:



All the information is instructed to general readers, i.e for users of the appliance.



All the information is instructed for special categories of reader, i.e. all skilled operators authorized to handle, transport, install, service, repair and scrap the appliance

The skilled operators may also read the information for the general readers for a more complete picture of the information provided if necessary.

1.2 Warning, Signs and Symbols









1.2.1 Warning

Warnings are indicated with a pictogram and a signal word.

The type and source of the risk as well as the consequences are described together with instructions for avoiding the danger. The margins of the pictograms and signal words used are explained in section “Signs” and “Symbols”

1.2.2 Signs

	Electric Shock Hazard or High Voltage Imminent danger → Non-observance leads to death or serious injury (caused by electric shock)
	Hot Surface Dangerous situation → Non-observance can lead to slight or semi-serious injury (caused by hot surface)
	Warning Damage → Non-observance can lead damage
	Pace Maker (Especially for Induction) Possible Danger → Non-observance can lead to death or serious injury
	Injury Risk Possible Danger → Non-observance can lead to death or serious injury
	PE → Connect wire to the earth



Important
→ non-observance can lead damage



Note
→ Note for special appliance



Attention
→ Non-observance can lead damage



User sign
→ information must be read by user



Technician sign
→ information must be read by technician



CE Certification
→ The appliance have a license of CE Certificate

1.2.3 Symbols

Symbols	Meaning	Explanation
1. 2.	Instruction, single step	Instruction must be followed in the order given
Bullet points, such as “1.1”, “a”, “ etc	Instruction, multiple steps	Instruction can be carried out in any sequence
→	Instruction, multiple steps	An action is required here

1.3 General Information of the Appliance



Nayati Electric Noodle Boiler is an excellent cooking appliance made of stainless steel with 12 kW of power rate. Water temperature is maintained by Heater Control with maximum working temperature of 100°C. The appliance is supported with bowls that can withstand to salt and acid and equipped with special noodle baskets with holder. This appliance is suitable for cooking noodle. Featuring is removable clip joint to connect Meritus family product. It is very important to keep this instruction book together with the appliance for future consultation. If this appliance sold or transferred elsewhere, make sure this book goes with it. Therefore, the new user can read about its functions and other relevant information.

1.4 Procedure for Requesting Service and Warranty



1.4.1 Requesting Service

Contact one of the authorized service centers for all requirements. When requesting service, state the data provide on the nameplate and provide a description of the fault.

1.4.2 Warranty

gives 12 months guarantee with certain conditions. will decline any claims of accidents caused by improper use, disobey rules, and/ or disobey warnings. Below are cases, which invalidate the guarantee:

1. Improper use by untrained person(s)
2. Disobey local regulation(s) related to installation and safety standards
3. Not doing routine maintenance
4. Replace certain parts with non-genuine spare part
5. Do not follow the manual instructions properly

If you have any doubts or questions related to our product, please call your nearest dealer

2. Safety Instruction



 **Important!** Before installing, place the appliance on solid, flat, stable and horizontal surface and connection availability.

Read this manual instruction carefully before using Electric Noodle Boiler. Below are safety instructions that strictly conformed:

1. Improper installation, maintenance, cleaning, or modification to the appliance could lead to severe injury or death and could damage the appliance.
2. The mechanics must instruct staff regularly to avoid accident and damage of the appliance.
3. Electric Noodle Boiler may be used for skilled staff only.
4. DO NOT place the appliance in a toxic area or have a risk of explosion.
5. DO NOT place the appliance near flammable materials such gasoline, fat, clothes, liquid gas, paper, etc.
6. DO NOT place the appliance in wet or humid room or condition such in rain or near water leaks, etc.
7. DO NOT use the appliance for drying clothes, paper, or living animals.
8. DO NOT use the appliance to heat non-food products.
9. Put the appliance in a good ventilated room.
10. Before cleaning or maintaining the appliance, detach the gas line and allow it to cool.
11. DO NOT touch the area  this sign means hot surface. Beware of severe burning injury.
12. DO NOT attempt to dismantle or repair the appliance. The authorized mechanics must do all jobs.



INJURY RISK!

- Avoid Electric Noodle Boiler Installation next to fat Fryer.
- Water could splash into the Fryer and may injure the user.
- It is recommended to keep a safe distance between Electric Noodle Boiler and other kitchen equipment like Fryer.



ELECTRIC SHOCK HAZARD!

- Authorized and qualified mechanic can do the maintenance and repairs.
- Turn OFF and disconnect the appliance before opening front panel and accessing electrical area inside the appliance.

3. Technical Data

3.1 Data Table



3.1.1 Technical Specification of Electric Noodle Boiler

Table 1 :

Technical Specification			
Model	NEN 16 A (ME)		
Overall Dimension (mm)	Width	Depth	Height
	400	750	850 / 870
Number of Heaters	2		
Electric Consumption	12 kW		
Electric Connection	400V 3PNE AC 50/60Hz		
Working Temperature (°C)	Max 100°C		
Bowl Capacity	30 liters (6 Noodle Baskets)		
Water Inlet Connection	R ½"		
Water Drain Connection	R 1"		

3.2 Data Plate



3.2.1 Technical plate reports the current setting.

Fig. 1

3.3 Overall Dimension



NEN 16 A (ME)

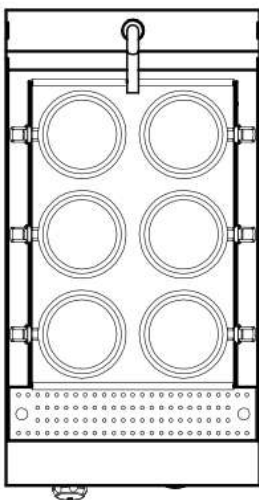
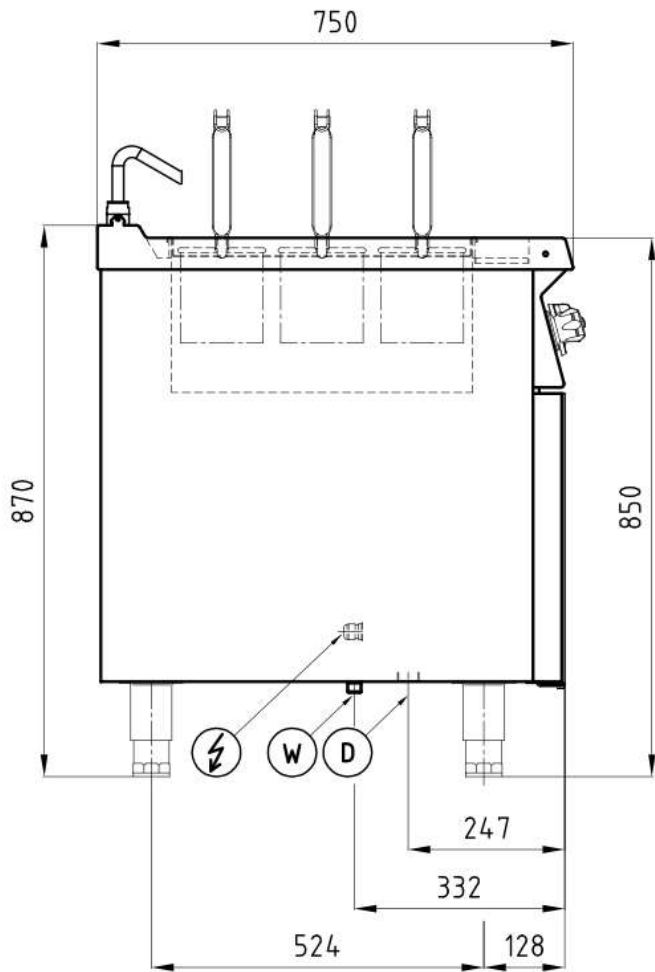
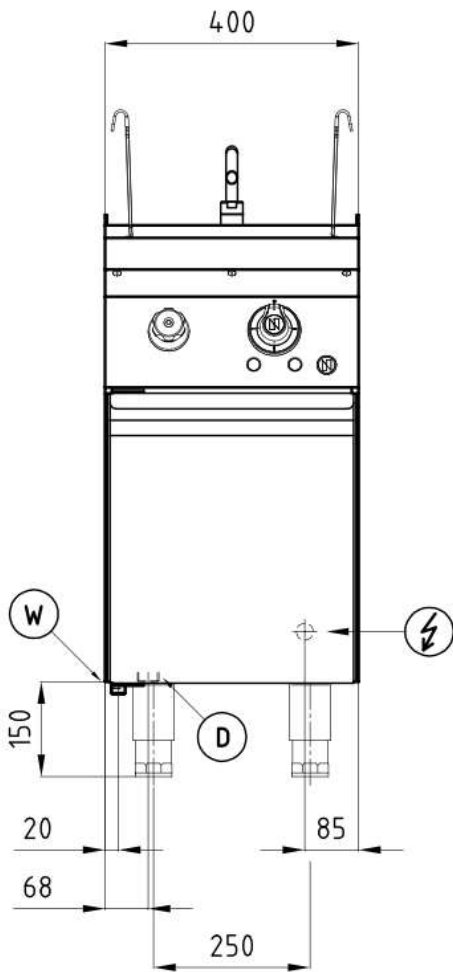



-  Electric Connection
-  Water Connection R 1/2"
-  Drain R 1"

Fig. 2

3.4 Component List

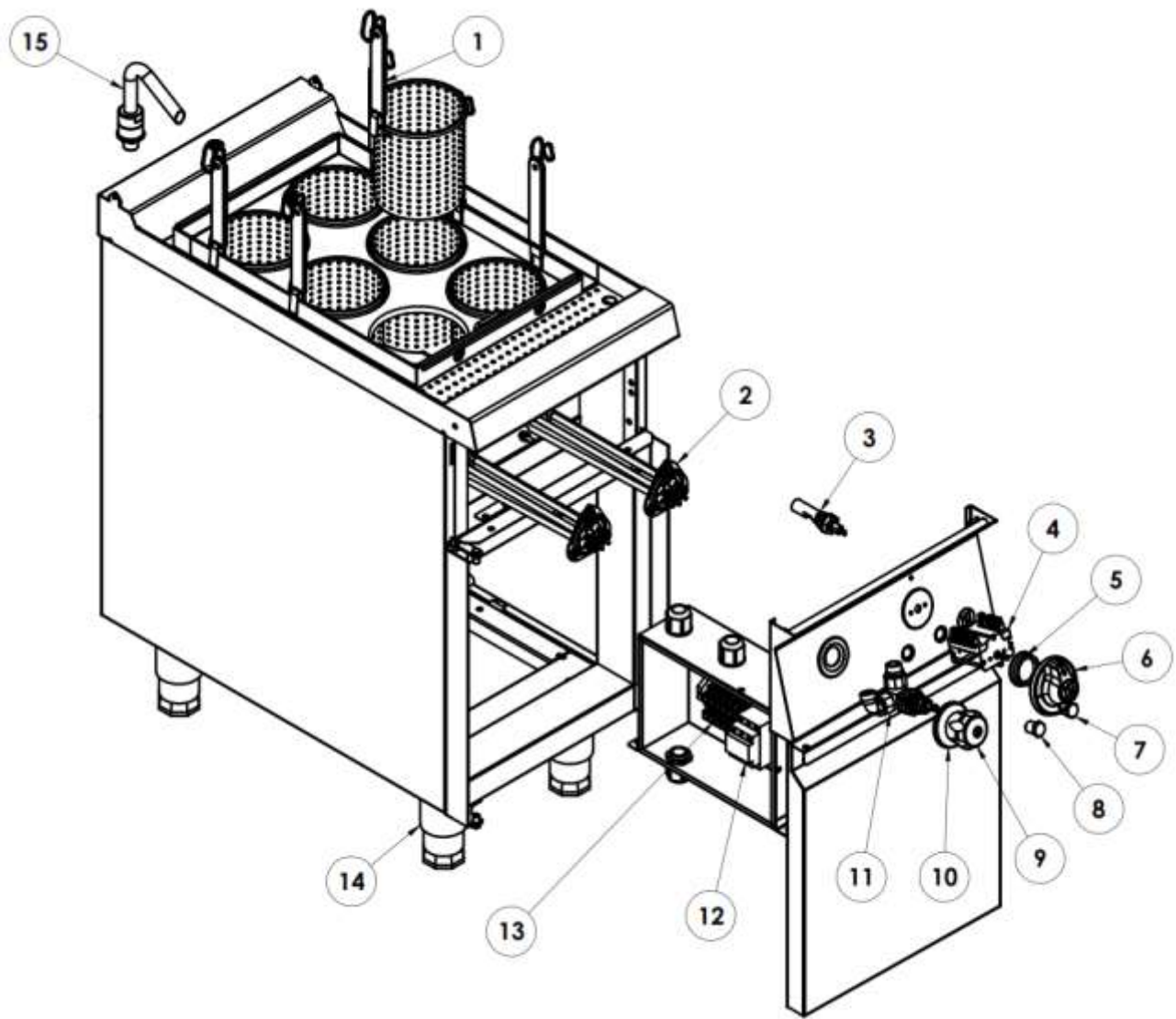

Fig. 3

Table 2 :

NO	PART CODE	DESCRIPTION	QTY
1	GS.2240C	Noodle Basket	6
2	PD.DW034GA	Immersion Heater 6 kW/230 V	2
3	PD.404Q3	Float Switch Horizontal	1
4	PD.4055BB	Rotary Switch 3 Steps	1
5	PD.G024	Seal For Electric Knob	1
6	PD.G021A	Electric Knob	1
	PD.G021A-13	Ring Electric Knob 0-1-2-3	1
7	PD.414KB-1	Pilot Light Green 230V	1
8	PD.414QA-1	Pilot Light Red 230V	1
9	PD.2458-1	Nut For Water Tap	2
	PD.2458A1	Water Tap Head Blue	1
10	PD.2458B	Water Tap Cap	1
11	PD.2459A2	Water Tap	1
12	KB.5034A	Magnetic Contactor 32 A	1
13	PD.2248G	Terminal Block With Screw (Grey)	3
	PD.2248I	Terminal Block With Screw (Blue)	2
	PD.2248H	Terminal Block With Screw (Green-Yellow)	1
	PD.CS202	Bracket	2
14	GS.3607A	Adjustable Leg	4
15	GS.3714A	Faucet	1

4. Handling and Installing



Important! Before installing, place the appliance on solid, flat, stable and horizontal surface and connection availability.

The following instructions are intended for authorized and qualified installer. Before doing installation, adjustment, and maintenance operations, the installer must follow local and legal regulations. Cut the gas/electric supply before doing any installation.

1. This appliance is using electric power. Electric services should be installed according to:
 - a. Local and international standards
 - b. Local recommendations related to building standards and codes
 - c. Directions and regulations from power supply companies
 - d. Regulation concern with prevention accident measures
 - e. Fire prevention regulations
 - f. Applicable I.E.C (International Electro technical Commission) regulations
2. Remove all packaging material and protective coatings.
3. Ensure electric power supply is sufficient to operate this appliance.
4. Before testing, put the appliance in a good ventilated room and keep all flammable material away.
5. Before cleaning or maintaining the appliance, please cut off electric power and isolate gas supply (if any) to the safe place.

4.1 Packaging and Transport



4.1.1 Packaging

The packaging is designed to reduce space and as appropriate to the type of transport used. To simplify transport, some components may be removed and suitably protected and packed for transport.

The packaging carries all information necessary for loading and unloading. When unpacking, check that all components are present in the correct quantities and are undamaged. The packaging material must be properly disposed of in accordance with legal requirements.

4.1.2 Transport

Different means of transport may be used, depending partly on the destination.

During transport, fix the packaging to the means of transport securely to prevent undesirable shifting.

4.2 Handling and Lifting



The appliance can be handled using fork-lift or hook equipment of suitable load-carrying capacity. Before lifting, check the position of the load's centre of gravity.



Important! When engaging with the lifting equipment, watch out for the gas/electric supply.

4.3 Safety Devices and Accessories



The appliance is provided with safety devices. The additional devices must be added if necessary to comply with the relevant legal requirement during the installation.



Important! Make the daily check that the safety devices are properly install and in good working order.

The appliance is equipped with the included or optional accessories. There are Noodle Basket with Holder, and Drain Filter as included accessory; Clip Plate for Joining as optional accessory.

4.4 Position and Fixing



1. Authorized personnel must do the installation.
2. Install the appliance according to National Safety Standard about electric-heated standard.
3. Install the appliance under an extractor fan to remove the cooking fumes.
4. Make sure that any object around or under Electric Noodle Boiler does not obstruct air volume required for air circulation.
5. Put away any flammable materials near Electric Noodle Boiler.
6. When the appliance is freestanding, keep a distance at least 10 cm from side, and rear walls. Especially when the appliance close to wall and does not protected with fire-resistant materials made.
7. Install the appliance separately or side by side with other appliance according to recommended range.
8. Put Electric Noodle Boiler on solid, flat, and horizontal surface.
9. Adjust the height of the four feet by using brackets.
10. Before turn the appliance ON, remove the protective film. Remove any adhesive with appropriate solvent.
11. Eliminate all packaging material according to national laws.

4.5 Electric Power Connection



1. Before connecting the appliance to the main supply, compare the electrical data in the rating plate (on the appliance side panel) to the local electric energy supply. Make sure the main voltage correspond to the voltage indicated on the nameplate of the appliance.
2. Registered installation companies must do the electric installation concerned with certain local and national regulations. The companies are responsible for interpret all regulation and perform the installation and safety instructions. The warning signs and nameplates must strictly conform.
3. The appliance equipped with a power terminal and connected with power cable and power socket.
4. DO NOT put the power cable near heat sources or water leakage area.



WARNING!

To avoid electric shock, it is necessary to have earth connection. You can find the earth connection at the terminal boards, identified with  symbol to where earth wire has to connect.



WARNING!

Incorrect voltage may damage the appliance.

- **NEN 16 A (ME) (400V 3PNE AC 50/60Hz 12kW)**

5. Use and Operation

5.1 Warning



This appliance is an electric cooker for professional use. It shall be used by authorized people only. Before starting, please make sure that the appliance is in good condition and put it in a good ventilated room. Below are several preliminaries warning that strictly conformed:

1. If there is a persistent breakdown, please contact authorized mechanic.
2. User is only responsible for daily routine cleaning for maintenance.
3. Qualified mechanics must do all operations related to installation and maintenance according to Regulation in force.
4. Use this Electric Noodle Boiler only for COOKING NOODLE. DO NOT use the Electric Noodle Boiler for other purposes. Any other uses may be considered as improper and dangerous use. Please control the appliance when operating.
5. Before operating Electric Noodle Boiler for the first time, carefully clean the appliance to remove industrial oil/ lubricant.
6. After using the Electric Noodle Boiler, turn the knob to OFF position.

5.2 Control Panel Description



5.2.1 For example : NEN 16 A (ME)

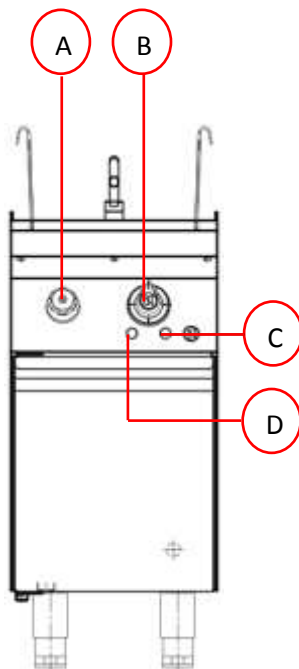

Fig. 4

- A : Water Tap
- B : Electric Knob
- C : Red Pilot Lamp
- D : Green Pilot Lamp

5.3 Switch ON/OFF



5.3.1 Turn the Appliance ON

1. Turn the Electric Knob to the right to switch ON the appliance. The green Pilot lamp will light to indicate the appliance is ready to use.
2. Turn the Electric Knob according to the number of heater used for efficient power (1/3 power, 2/3 power or full power).
3. The Red Pilot lamp will light to indicate error when the water is empty, so please filling it.



NOTE!

It is not need many times for boiling the water

5.3.2 Turn the Appliance OFF

1. Turn the Electric Knob to zero (0) position. The green Pilot lamp will OFF to indicate the appliance is OFF.
2. Empty the tank by turn the handle of water outlet anticlockwise.



WARNING!

Water Hardness above 100 ppm can break the tank.

If the tank is broken, and it is caused by water hardness more than 100 ppm, Nayati will not cover a warranty.



WARNING!

Filling the tank : First check that the drain valve is closed; Fill the tank with water up to the maximum level (level of overflow) by means of the filling tap.

Emptying the tank : The tank must be emptied with care and only when the water has cooled.

6. Routine Cleaning and Maintenance



Clean the appliance to keep the functionality and durability. In the case of any failures, do not attempt to solve the problem but call your dealer immediately to ask for help. Do not attempt to dismantle the appliance, specialized mechanics must do all job.

For routine cleaning process, please follow procedure below and notice the warning:

1. Make sure the circuit-breaker to disconnect it from the electrical mains is OFF.
2. Allow water to cool to a safe handling temperature.
3. Remove baskets and clean them using standard dish-washing detergent. Be sure to rinse baskets and dry thoroughly.
4. Drain the water completely from the bowls. Thoroughly clean and rinse the bowls. Clean with dish-washing detergent, rinse with plenty of water and dry it.
5. Clean the body (exterior surfaces) with dish-washing detergent, use sponge to clean hard residue or spills, rinse and wipe dry.
6. DO NOT leave acid food such as vinegar, salt, lemon, etc on the stainless steel parts because it can ruin them.
7. NEVER wash the appliance with direct high-pressure jet water.
8. If the cooker will not used for a long time, briskly rub the steel part slightly with a damp cloth and Vaseline oil. After that, wrap with protective film and put the appliance in a good ventilated room.



ATTENTION!

- ! If you find the lighting and control devices are difficult to use, please contact the manufacturer immediately, which will provide you necessary assistance or call dealer.
- ! Please check the appliance periodically for 6 months. Contact your dealer that will supply assistance to repair and set interval.
- ! Authorized and qualified personnel must do all service.

7. Trouble Shooting

Table 3 :



NO.	PROBLEM	CAUSE	CORRECTIVE ACTION
1	Water is not heating up but green pilot lamp is light on	Rotary switch damaged	Check and replace
		Floating switch & Red pilot lamp damaged	Check and repair
2	Pilot lamp does not function	No electric current	Check and repair
		Pilot lamp damaged	Check and replace
3	Water valve does not function	No water inlet	Check water inlet
		Water valve damaged	Check and replace

8. General Exclusions

GENERAL EXCLUSIONS

- Damage to Rotary Switches and buttons.
- Discoloration of components due to heat.
- Drainage does not meet requirements.
- Lubrication of moving parts.
- Corrosion caused by the use of chemical cleaners.
- Replacement of components due to internal contamination as a result of spillage or accumulation of grease/food debris due to a lack of cleaning.
- Cabinet, drawer and door seals are considered consumable items and will not be replaced under warranty.
- Light bulbs, lens covers and sticker display are considered consumable items and will not be replaced under warranty.
- Enamel coated components if impacted sufficiently will crack or chip, such damage is not covered by the terms of this warranty.
- Rectification where non-Nayati specified parts have been used.
- Where user error is established.

Gas general

- Poor combustion caused by lack of cleaning.
- Failure of components directly linked to poor cleaning and/or maintenance.
- Cleaning of burners jets.
- Cleaning/adjustment of pilots and thermocouples.
- Correction of gas pressure to the appliance.
- Renewing of gas supply fittings external to the appliance.

Electrical general

- Resetting of safety devices including fuses where no other fault exists.
- Renewing of supply cable ends.

Fryers

- Replacement of components damaged by cooking oils due to a lack of cleaning and care when replacing oil.
- Damage to thermostats.

Steamers

- Corrosion caused by high water hardness.
- Damage resulting from lack of water flow to the unit.

Induction

- Chipped or damaged glass not reported at time of delivery.
- Damage due to blocked or missing air filters.
- Damage to the generator due to wrong pan type/size used.

Gas Charcoal grills and salamanders

- Impact damage caused by the user due to misuse outside of the design scope.

Chargrill Radiant covers

- Radiant covers are considered consumable items and may corrode if not regularly cleaned due to prolonged contact with salt and fats and will not be replaced under warranty.
- Damage to heaters due to failure to replace radiant covers is not covered by the warranty.

Heated and chilled food displays

- Chipped or damaged glass not reported at time of delivery.
- Damage to components resulting from restricted airflow to inlets and outlet.
- Damage to components resulting from accumulation of airborne particles.
- Condensation on cold surfaces if units are installed in environments beyond specification.

Dishwashing

- Corrosion caused by high water hardness.
- Chemical pump due to misuse chemical agent.
- Washing accessories : basket, curtain.
- Malfunction caused by high water hardness.