



MOD : BCC/XT-06-R2

Production code : 729735

09/2025

Blast Chillers/Freezers

Lengthwise

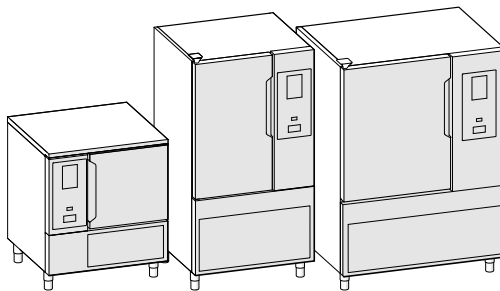

EN Installation manual *



Installation diagram
model 30kg 6GN 1/1

type SKCH30B

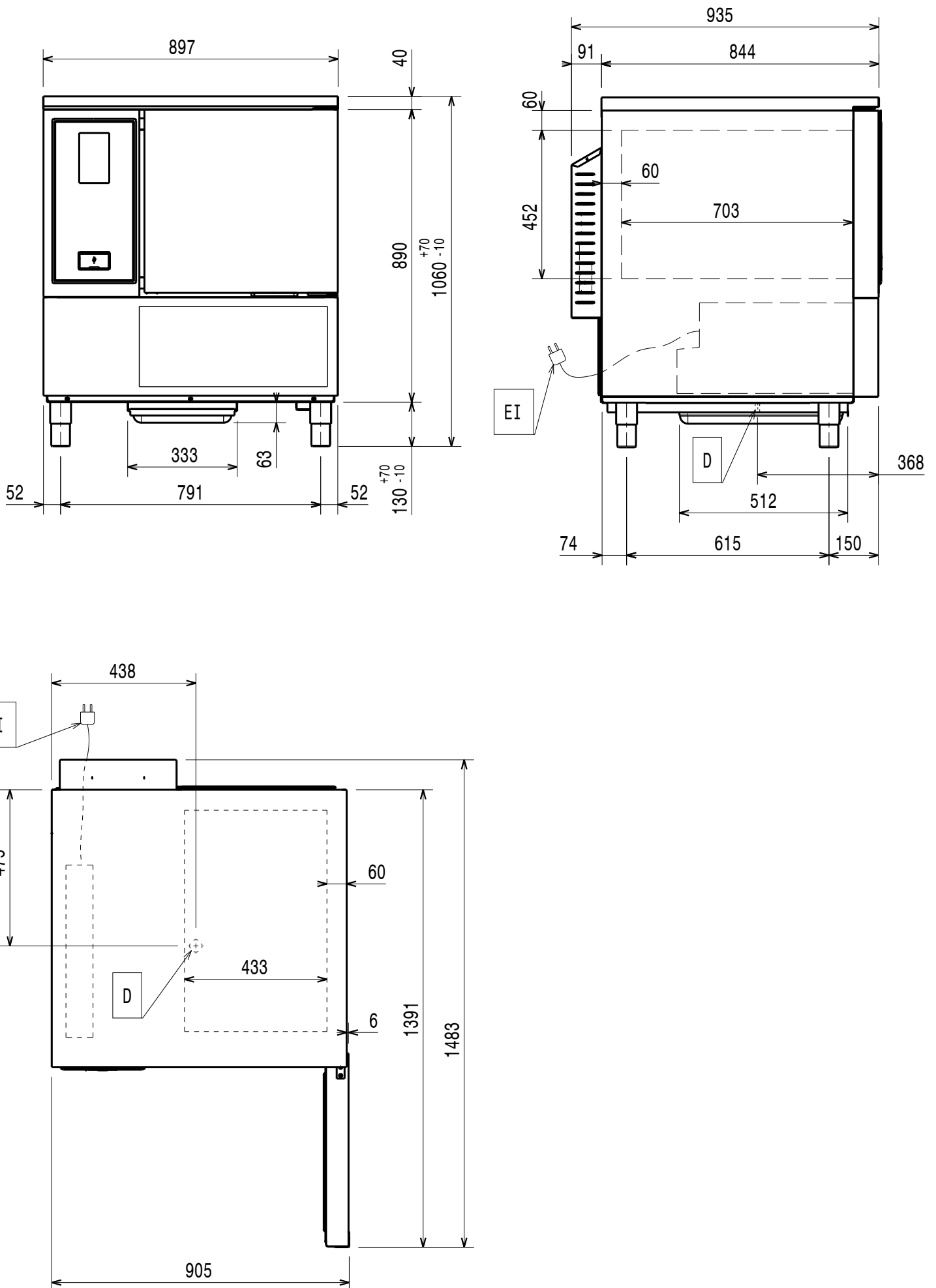

Installation diagram
model 50kg 10GN 1/1

type SKCH50B

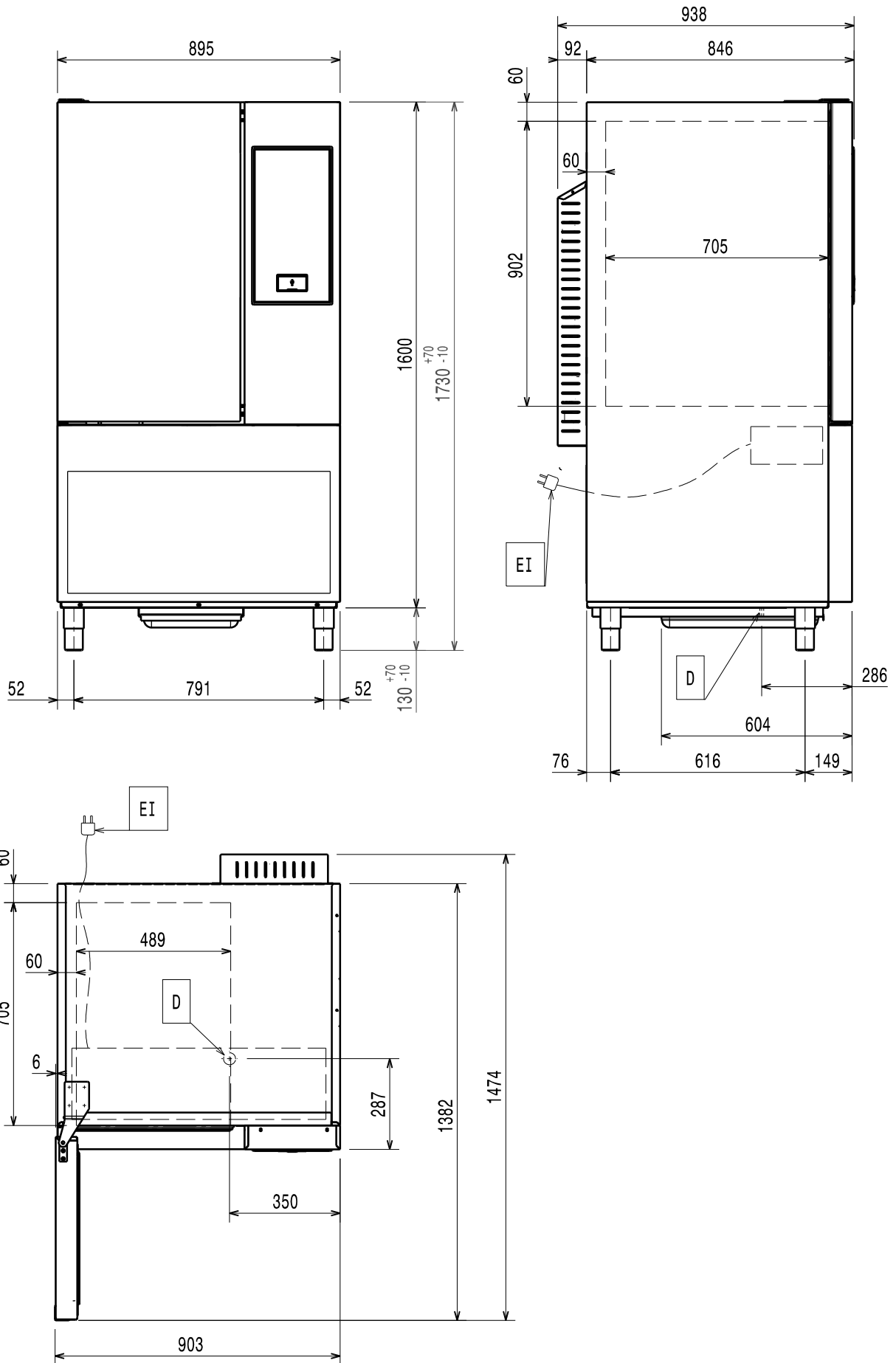

El = Power cable length

D = Compartment drain hole

Foreword

 Read the following instructions, including the warranty terms before installing and using the appliance.

Visit our website www.electroluxprofessional.com and open the Support section to:

 Register your product

 Get hints & tips of your product, service and repair information

The installation, use and maintenance manual (hereinafter Manual) provides the user with information necessary for correct and safe use of the appliance.

The following must not be considered a long and exacting list of warnings, but rather a set of instructions suitable for improving appliance performance in every respect and, above all, preventing injury to persons and animals and damage to property due to improper operating procedures.

All persons involved in appliance transport, installation, commissioning, use and maintenance, repair and disassembly must consult and carefully read this manual before carrying out the various operations, in order to avoid wrong and improper actions that could compromise the appliance's integrity or endanger people. Make sure to periodically inform the user regarding the safety regulations. It is also important to instruct and update personnel authorised to operate on the appliance, regarding its use and maintenance.

The manual must be available to operators and carefully kept in the place where the appliance is used, so that it is always at hand for consultation in case of doubts or whenever required.

If, after reading this manual, there are still doubts regarding appliance use, do not hesitate to contact the Manufacturer or the authorised Service Centre to receive prompt and precise assistance for better operation and maximum efficiency of the appliance. During all stages of appliance use, always respect the current regulations on safety, work hygiene and environmental protection. It is the user's responsibility to make sure the appliance is started and operated only in optimum conditions of safety for people, animals and property.



IMPORTANT

- The manufacturer declines any liability for operations carried out on the appliance without respecting the instructions given in this manual.
- The manufacturer reserves the right to modify the appliances presented in this publication without notice.
- No part of this manual may be reproduced.
- This manual is available in digital format by:
 - contacting the dealer or reference customer care;
 - downloading the latest and up to date manual on the web site www.electroluxprofessional.com;
- The manual must always be kept in an easily accessed place near the appliance. Appliance operators and maintenance personnel must be able to easily find and consult it at any time.

Contents

A	WARNING AND SAFETY INFORMATION	8
A.1	General information	8
A.2	Description of type reference	8
A.3	Personal protection equipment	8
A.4	General safety	9
A.5	Safety signs to be placed on the appliance or near its area	9
A.6	Residual risks	9
A.7	Technical data	10
A.8	Climatic Class	10
A.9	Transport, handling and storage	10
A.10	Installation and assembly	10
A.11	Electrical connection	10
A.12	Electrical connection for appliances with cable without plug	10
A.13	Electrical connection for appliances with plug	11
A.14	Positioning	11
A.15	Wall fixing	11
A.16	Stacking installation	11
A.17	Appliance space limitations	11
A.18	Appliance disposal	11
B	APPLIANCE AND MANUFACTURER'S IDENTIFICATION DATA	11
C	DATA PLATE POSITION	12
D	GENERAL INFORMATION	12
D.1	Introduction	12
D.2	Copyright	12
D.3	Keeping the manual	12
D.4	Recipients of the manual	12
D.5	Definitions	12
D.6	Responsibility	12
D.7	Customer packaging checks	13
D.8	Storage	13
E	TECHNICAL DATA	13
E.1	Materials and fluids used	13
E.2	Main technical characteristics	13
F	INSTALLATION AND ASSEMBLY	13
F.1	Introduction	13
F.2	Customer's responsibilities	14
F.3	Unpacking instructions	14
F.4	Disposal of packing	14
F.5	6GN 1/1 – 10GN 1/1 – 10GN 2/1 models	14
F.5.1	Positioning	14
F.5.2	Feet levelling	14
F.5.3	Back Spacer	14
F.5.4	Condensate tray positioning	14
F.5.5	Stacking installation	15
F.5.6	Positioning the top	16
F.5.7	Draining water	16
F.5.8	Multifunctional internal structure	17
G	APPLIANCE SETUP	18
G.1	Introduction	18
H	MACHINE DISPOSAL	18
H.1	Procedure regarding appliance disposal	18

A WARNING AND SAFETY INFORMATION

A.1 General information

To ensure safe use of the appliance and a proper understanding of the manual it is necessary to be familiar with the terms and typographical conventions used in the documentation. The following symbols are used in the manual to indicate and identify the various types of hazards:

 **WARNING**
Danger for the health and safety of operators.

 **WARNING**
Danger of electrocution - dangerous voltage.

 **CAUTION**
Risk of damage to the appliance or the product.

 **WARNING**
Risk of fire / Flammable materials

 **IMPORTANT**
Important instructions or information on the product

 Equipotentiality

 Read the instructions before using the appliance

 Clarifications and explanations

- Only specialised personnel are authorised to operate on the appliance.
- This appliance is to be intended for commercial and collective use, for example in kitchens of restaurants, canteens, hospitals and in commercial enterprises such as bakeries, butcheries, etc., not for continuous mass production of food. Any other use is deemed improper.





- This appliance is not intended for use by persons (including children) with reduced physical, sensory or mental capabilities, or lack of experience and knowledge, unless they have been given supervision or instruction concerning use of appliance by a person responsible for their safety.
- (ONLY FOR EUROPE) This appliance can be used by children aged from 8 years and above and persons with reduced physical, sensory or mental capabilities or lack of experience and knowledge if they have been given supervision or instruction concerning use of the appliance in a safe way and understand the hazards involved.
- Children should be supervised to ensure that they do not play with the appliance.
- Keep all packaging and detergents away from children.
- Cleaning and user maintenance shall not be made by children without supervision.
- For your safety do not store or use gasoline or other flammable materials, vapours and liquids in the vicinity of this or any other appliance.
- Do not store explosive substances, such as pressurized containers with flammable propellant, in this appliance.
- Refer to the data given on the appliance's data plate for relations with the Manufacturer (e.g. when ordering spare parts, etc.).
- When scrapping the appliance, the marking must be destroyed.
- Save these instructions carefully for further consultation by the various operators.

A.2 Description of type reference

SKCH...	
SKCH	Skyline blast chiller/freezer
	Capacity
▪	30: 30/30 kg chilling / freezing (6 GN 1-1)
	50: 50/50 kg chilling / freezing (10 GN 1-1)
	70: 100/70 kg chilling / freezing (10 GN 2-1)
▪	B: Built-in cooling unit
	Refrigerant type
▪	HC: flammable refrigerant (R290)

A.3 Personal protection equipment

Summary table of the Personal Protection Equipment (PPE) to be used during the various stages of the appliance's service life.

Stage	Protective garments 	Safety footwear 	Gloves 	Glasses 	Safety helmet 
Transport	—	●	○	—	○
Handling	—	●	○	—	—
Unpacking	—	●	○	—	—
Installation	—	●	● ¹	—	—
Normal use	●	●	● ²	—	—
Adjustments	○	●	—	—	—
Routine cleaning	○	●	● ¹⁻³	○	—
Extraordinary cleaning	○	●	● ¹⁻³	○	—
Maintenance	○	●	○	—	—
Dismantling	○	●	○	○	—
Scrapping	○	●	○	○	—

Stage	Protective garments	Safety footwear	Gloves	Glasses	Safety helmet
					
Key:					
●	PPE REQUIRED				
○	PPE AVAILABLE OR TO BE USED IF NECESSARY				
—	PPE NOT REQUIRED				

1. During these operations, gloves must be cut-resistant. Failure to use the personal protection equipment by operators, specialized personnel or users can involve exposure to harm to health (depending on the model).
2. During these operations, gloves must protect hands from the cold tray when being removed from the appliance. Failure to use the personal protection equipment by operators, specialised personnel or users can involve exposure to chemical risk and cause possible harm to health (depending on the model).
3. During these operations, gloves must be suitable for contact with chemical substances used (refer to the safety data sheet of the substances used for information regarding the required PPE). Failure to use the personal protection equipment by operators, specialized personnel or users can involve exposure to chemical risk and cause possible harm to health (depending on the model).

A.4 General safety



- The appliances are provided with electric and/or mechanical safety devices for protecting workers and the appliance itself.
- Never operate the appliance, removing, modifying or tampering with the guards, protection or safety devices.
- Do not make any modifications to the parts supplied with the appliance.
- Several illustrations in the manual show the appliance, or parts of it, without guards or with guards removed. This is purely for explanatory purposes. Do not use the appliance without the guards or with the protection devices deactivated.





Disconnect the appliance from the power supply before carrying out any installation, assembly, cleaning or maintenance procedure.

- Do not remove, tamper with or make illegible the marking and safety, danger and instruction signs and labels on the appliance.
- The A-weighted emission sound pressure level does not exceed 70 dB(A).¹
- Carefully avoid exposure of the equipment to ozone - do not use ozonizers in the rooms where the equipment is installed.
- The following operations have to be carried out by specialised authorised personnel or Customer Care Service provided with all the appropriate personal protection equipment (A.3 *Personal protection equipment*), tools, utensils and ancillary means, who can ask the manufacturer to supply a servicing manual:
 - Installation and assembly
 - Installation of the refrigerant fluid condensing unit
 - Positioning
 - Electrical connection
 - Appliance cleaning, repair and extraordinary maintenance
 - Appliance disposal
 - Work on electrical equipment
 - Dismantling operations of appliances which use R290 or R-744 (with a refrigeration system under high pressure)
 - Dismantling operations of appliances which use flammable insulation blowing gases;

A.5 Safety signs to be placed on the appliance or near its area

Prohibition	Meaning
	do not remove the safety devices
	do not use water to extinguish fires (placed on electrical parts)

Danger	Meaning
	caution hot surface
	danger of electrocution (shown on electrical parts with indication of voltage)

A.6 Residual risks

The appliance has several risks that were not completely eliminated from a design standpoint or with the installation of adequate protection devices. Nevertheless, through this manual the Manufacturer has taken steps to inform operators of such risks, carefully indicating the personal protection equipment to be used by them. In order to reduce the risks, provide for sufficient spaces while installing the unit.

To preserve these conditions, the areas around the appliance must always be:

- kept free of obstacles (e.g. ladders, tools, containers, boxes, etc.);
- clean and dry;
- well lit.

For the Customer's complete information, the residual risks remaining on the appliance are indicated below: such actions are deemed improper and therefore strictly forbidden.

1. The noise emission values have been obtained according to EN ISO 11204. The value could increase depending on the workplace where measured.

Residual risk	Description of hazardous situation
Slipping or falling	The operator can slip due to water, any liquid or dirt on the floor
Burns/abrasions (e.g. heating elements, cold pan, cooling circuit plates and pipes)	The operator deliberately or unintentionally touches some components inside the appliance without using protective gloves.
Electrocution	Contact with live parts during maintenance operations carried out with the electrical panel powered
Falling from above	The operator intervenes on the appliance using unsuitable systems to access the upper part (e.g. rung ladders, or climbs on it)

Residual risk	Description of hazardous situation
Crushing or injury	The specialised personnel may not correctly fix the control panel when accessing the technical compartment. The panel could close suddenly.
Tipping of loads	When handling the appliance or the packing containing it, using unsuitable lifting systems or accessories or with the unbalanced load
Chemical (refrigerant gas)	Inhalation of refrigerant gas. Therefore always refer to the appliance labels

A.7 Technical data

- The data plate and the energy labelling refer to original manufactured configuration.
- The appliance that can operate at 50 or 60 Hz does not need any setting by the user.

Materials and fluids used

- R290 gas is potentially flammable and explosive. Take every possible precaution to prevent any risk linked to the nature of this gas during any routine and/or extraordinary operation carried out on the appliance.

A.8 Climatic Class

The climatic class given on the data plate refers to the following values:

- CLIMATIC CLASS: 5
 - 43°C (IEC/EN 60335-2-89)
 - 40°C room with 40% relative humidity (IEC/EN ISO 23953).

A.9 Transport, handling and storage

- Transport (i.e. transfer of the appliance from one place to another) and handling (i.e. transfer inside workplaces) must occur with the use of special and adequate means.
- Please refer to indications on packaging for stackability during transport, handling and storage.
- Do not stand under suspended loads during loading or unloading operations. Unauthorized personnel must not enter the work area.
- The weight of the appliance alone is not sufficient to keep it steady.
- For appliance handling, do not lift and anchor it to movable or weak parts such as: casings, electrical raceways, pneumatic parts, etc.
- Do not push or pull the appliance to move it, as it may tip over. Use proper tool to lift the appliance.
- Arrange a suitable area with flat floor for appliance unloading and storage operations.
- Appliance transport, handling, shifting and storage personnel must be adequately instructed and trained regarding the safely use of lifting systems and personal protection equipment suitable for the type of operation carried out.
- When removing the anchoring systems, make sure the stability of the appliance parts does not depend on the anchoring and, therefore, that this operation does not cause the load to fall off the vehicle. Before unloading the appliance components, make sure all the anchoring systems are removed.

A.10 Installation and assembly

- The installer must evaluate the minimum volume of the installation's environment necessary to reduce the risks related to danger caused by the flammability and toxicity of the refrigerant present in the appliance.
- The operations described must be carried out in compliance with the current safety regulations and provisions in force in the country of use.
- The appliance is not suitable for installation outdoors and/or in places exposed to atmospheric agents (rain, direct sunlight, etc.).

A.11 Electrical connection

- The power supply system must be suitable for the rated current of the connected appliance; the connection must be carried out in compliance with the regulations and provisions in force in the country of use.
- The information regarding the appliance power supply voltage and frequency is given on the data plate.
- Install between the power cable and the electric line a differential thermal-magnetic switch suitable for the

absorption specified on the data plate, with contact gap enabling complete disconnection in category III overvoltage conditions and complying with the regulations in force.

For the correct sizing of the switch or plug, refer to the absorbed current specified on the appliance data plate.

- After making the connection, with the appliance running check that the power supply does not fluctuate by $\pm 10\%$ the rated voltage.
- If the power cable is damaged or too short, it must be replaced by the Customer Care Service or in any case by specialised personnel, in order to prevent any risk.
- The manufacturer declines any liability for damage or injury resulting from breach of the above rules or non-compliance with the electrical safety regulations in force in the country where the appliance is used.

A.12 Electrical connection for appliances with cable without plug

- The connection point has an efficient earth contact and the mains voltage and frequency match that given on the data

- plate. In case of doubts regarding the efficiency of the earth wire, have the system checked by specialised personnel.
- The appliance must be permanently connected to the power supply, respecting the polarities:
 - brown/black²/gray²: phase
 - yellow/green: earth
 - blue: neutral
 - An H07RNF type power cable (code 60245 IEC 66) is used for the permanent connection to the mains; in case of replacement, use a type with at least these characteristics. When replacing the cable, the earth wire must be kept longer than the live and neutral wires.
 - The differential thermal-magnetic switch must be lockable in the open position in case of maintenance.
 - If using a plug, it must comply with the national installation rules. The plug must also be:
 - accessible after the appliance has been positioned
 - in the place of installation;

- in a position always visible to the operator performing the intervention during maintenance operations;

A.13 Electrical connection for appliances with plug

- To connect to the power supply, insert the power cable plug in the corresponding mains socket, first making sure:
 - the socket has an efficient earth contact and the mains voltage and frequency match that given on the dataplate. In case of any doubts regarding the efficiency of the earth connection have the system checked by specialised personnel.
 - the system power supply is arranged and able to take the actual current absorption and that it is correctly executed according to the regulations in force in the country of use.
- The plug must be accessible after positioning the appliance in the place of installation.
- The plug must be in a position always visible to the operator performing the intervention during maintenance operations.

A.14 Positioning

- Install the appliances, taking all the safety precautions required for this type of operation, also respecting the relevant fire-prevention measures.
- In case of “Marine” models, the appliances must be fixed to the floor.
- Prevent the areas where the appliance is installed to be polluted with corrosive substances (chlorine, etc.). The manufacturer declines any liability for corrosive effects due to external causes.

A.15 Wall fixing

- In case of installation on wheels, the appliances must be secured to building structure; follow the instructions given in the installation manual included in the kit.

A.16 Stacking installation

- The “Cook&Chill” column installations for safety reasons MUST be fixed to the wall by means of the 2 brackets included in the appliance.

A.17 Appliance space limitations

- Make sure to position the appliance at least 50 mm from any other machines present in the room (in fact, close proximity can create problems of condensate forming on the walls of the appliance), also taking into consideration the space needed for door opening;

A.18 Appliance disposal

- Make the appliance unusable by removing the power cable and any compartment closing devices, to prevent the possibility of someone becoming trapped inside.

B APPLIANCE AND MANUFACTURER'S IDENTIFICATION DATA

The data plate gives the product identification and technical data.

An example of the marking or data plate on the appliance is given below:

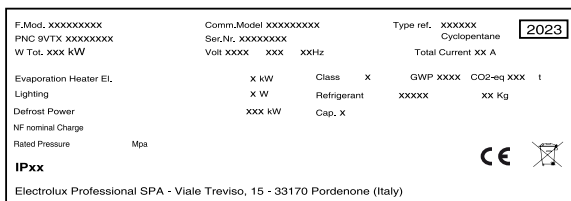

The meaning of the various information given on it is listed below:

F.Mod.	factory description of product
Comm.Mod.	commercial description
PNC	production number code
Ser.No.	serial number
Type ref.	certification group of the appliance
Cyclopentane	expanding gas used in insulation

V	power supply voltage
Hz	power supply frequency
kW	power input
A	absorbed current
Evaporation heater El.	evaporation heating element power
Class	climatic class
GWP	global warming potential
CO2 eq	quantity of greenhouse gases
Lighting	internal light
Cap.	nominal capacity
Refrigerant	type of refrigerant gas
Defrost power	current absorbed
CE	CE marking
	WEEE symbol
IPX4	dust and water protection rating

2. present only in appliances with three-phase power supply

C DATA PLATE POSITION



NOTE!

In **6GN 1/1 – 10GN 1/1 – 10GN 2/1** models, the dataplate is located on the lower part of the left side (or right side, depending on the model) of the appliance. The plate giving the appliance PNC code and serial number is located inside the condenser panel.

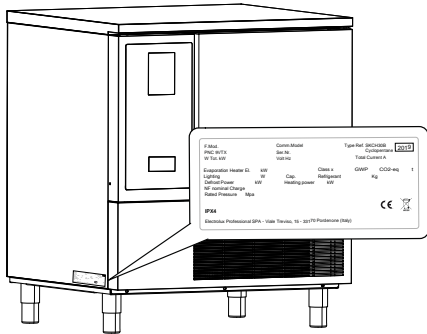

NOTE!

The radio transmitter module has the following technical specifications:

- the nominal frequency and transmitted power (radiated and/or conducted) used by the radio equipment, as reflected in the Technical Documentation;
- for radio equipment using standardized technologies, e.g. GSM/3G/LTE, indication of the frequency band in the way they are commonly well-known (such as GSM 900, 1800). Where different power levels are possible, the nominal maximum power would be stated.
- frequency range is between 2.400GHz to 2.472GHz
- transmitted power is below 20dBm

D GENERAL INFORMATION

D.1 Introduction

This manual contains information relevant to various appliances. The product images in this guide are only an example.

The drawings and diagrams given in the manual are not in scale. They supplement the written information with an outline, but are not intended to be a detailed representation of the appliance supplied.

The numerical values given on the appliance installation diagrams refer to measurements in millimeters and/or inches.

D.2 Copyright

This manual is intended solely for consultation by the operator and can only be given to third parties with the permission of Electrolux Professional SpA.

D.3 Keeping the manual

The manual must be carefully kept for the entire life of the appliance, until scrapping. The manual must stay with the appliance in case of transfer, sale, hire, granting of use or leasing.

D.4 Recipients of the manual

This manual is intended for:

- the carrier and handling personnel;
- installation and commissioning personnel;
- specialised personnel (see service manual).

D.5 Definitions

Listed below are the definitions of the main terms used in the manual. It is advisable to read them carefully before use.

Operator	appliance installation, adjustment, use, maintenance, cleaning, repair and transport personnel.
Manufacturer	Electrolux Professional SpA or any other service centre authorised by Electrolux Professional SpA.
Operator for normal appliance use	an operator who has been informed and trained regarding the tasks and hazards involved in normal appliance use.

Customer Care service personnel	an operator instructed/trained by the Manufacturer and who, based on his professional and specific training, experience and knowledge of the accident-prevention regulations, is able to appraise the operations to be carried out on the appliance and recognise and prevent any risks. His professionalism covers the mechanical, electrotechnical and electronics fields etc.
Danger	source of possible injury or harm to health.
Hazardous situation	any situation where an operator is exposed to one or more hazards.
Risk	a combination of probabilities and risks of injury or harm to health in a hazardous situation.
Protection devices	safety measures consisting of the use of specific technical means (guards and safety devices) for protecting operators against risks.
Guard	an element of a appliance used in a specific way to provide protection by means of a physical barrier.
Safety device	a device (other than a guard) that eliminates or reduces the risk; it can be used alone or in combination with a guard.
Customer	the person who purchased the appliance and/or who manages and uses it (e.g. company, entrepreneur, firm).
Electrocution	an accidental discharge of electric current on a human body.

D.6 Responsibility

The Manufacturer declines any liability for damage and malfunctioning caused by:

- non-compliance with the instructions contained in this manual;
- repairs not carried out in a workmanlike fashion, and replacements with parts different from those specified in the spare parts catalogue (the fitting and use of non-original spare parts and accessories can negatively affect appliance operation and invalidates the original manufacturer warranty);
- operations carried out by non-specialised personnel;
- unauthorized modifications or operations;
- missing, lack or inadequate maintenance;
- improper appliance use;

- unforeseeable extraordinary events;
- use of the appliance by uninformed and / or untrained personnel;
- non-application of the current provisions in the country of use, concerning safety, hygiene and health in the workplace.

The Manufacturer declines any liability for damage caused by arbitrary modifications and conversions carried out by the user or the Customer.

The employer, workplace manager or service technician are responsible for identifying and choosing adequate and suitable personal protection equipment to be worn by operators, in compliance with regulations in force in the country of use.

The Manufacturer declines any liability for inaccuracies contained in the manual, if due to printing or translation errors.

Any supplements to the installation, use and maintenance manual the Customer receives from the Manufacturer will form an integral part of the manual and therefore must be kept together with it.

D.7 Customer packaging checks

- The forwarder is responsible for the goods during transport and delivery.
- Make a complaint to the forwarder in case of visible or hidden damage.

- Specify any damage or shortages on the dispatch note.
- The driver must sign the dispatch note: the forwarder can reject the claim if the dispatch note is not signed (the forwarder can provide the necessary form).
- For hidden damage or shortages becoming apparent only after unpacking, request the forwarder for inspection of the goods within and no later than 15 days after delivery.

After packaging checks

1. Remove the packaging.
Take care when unpacking and handling of the appliance to not cause any shocks on itself.
2. Keep all the documentation contained in the packaging.

D.8 Storage

The appliance and/or its parts must be stored and protected from damp, in a non-aggressive place, free of vibrations and with room temperatures between 5°C and 50°C.

The place where the appliance is stored must:

- can take the appliance load,
- have a flat support surface to avoid deforming the appliance or damage to the support feet.

E TECHNICAL DATA



WARNING

Refer to “*Warning and Safety Information*”.

E.1 Materials and fluids used

The areas in contact with the food product are in steel; there are stainless steel supports and screws inside the above mentioned areas.

The evaporator unit is in copper-aluminium with anti-corrosion non-toxic coating.

The fluorinated gases are contained in a hermetically sealed device.

HC refrigerant fluid R290, complying with the current regulations, is used in the refrigerating units. The type and quantity of gas used are given on the dataplate.

The CO2 equivalent of the gas may be calculated multiplying GWP value by quantity of gas.

E.2 Main technical characteristics

Power supply voltage V	380–415V/3ph+N/50Hz ¹ 380–400V/3ph+N/60Hz ¹
------------------------	--

1. Depending on the model

Trays

	Gastronorm Trays (GN1/1) (530mm x 325mm)	Pastry Trays (400mm x 600mm)
6GN 1/1	6	6
10GN 1/1	10	10

	Gastronorm Trays (GN2/1) (650mm x 530mm)	Pastry Trays (400mm x 600mm)
10GN 2/1	10	10

F INSTALLATION AND ASSEMBLY

F.1 Introduction



WARNING

Refer to “*Warning and Safety Information*”.

To ensure correct operation of the appliance and maintain safe conditions during use, carefully follow the instructions given in this chapter.

Check and, if necessary, level the appliance after positioning. Incorrect levelling can cause appliance malfunctioning.



CAUTION

Before moving the appliance make sure the load bearing capacity of the lifting equipment used is suitable for its weight.



NOTE!

Appliances with incorporated refrigerating unit must be handled upright. If the appliance is handled in a horizontal position, make sure to wait a few hours in upright position before making it operational.



CAUTION

- Install the appliance in a ventilated place, away from heat sources such as radiators or air conditioning systems, to allow correct cooling of the refrigerating unit components.
- Never cover the condenser, even temporarily, as this can compromise its proper operation and therefore that of the appliance.
- The appliance must be taken to the place of installation and removed from the packing base only when being installed.

F.2 Customer's responsibilities

The tasks and works required of the Customer are:

- check the floor planarity on which the appliance is placed;
- arrange an earthed power socket of suitable capacity for the input specified on the data plate;



NOTE!

For information regarding the electrical connection, refer to "A.11 Electrical connection".

F.3 Unpacking instructions

Unpack the appliance carrying out the following operations:

- if present, cut the straps and remove the protective film, taking care not to scratch the surface if scissors or blades are used;
- if present, remove the cardboard top, the polystyrene corners and the vertical protection pieces;
- for appliances with stainless steel surfaces, remove the protective film very slowly without tearing it, to avoid leaving glue stuck to the surface;
- should this happen, remove the traces of glue with a non-corrosive solvent, rinsing it off and drying thoroughly;
- it is advisable to go over all the stainless steel surfaces with a rag soaked in paraffin oil in order to create a protective film.

F.4 Disposal of packing

The packing must be disposed of in compliance with the current regulations in the country where the appliance is used. All the packing materials are environmentally friendly.

They can be safely kept, recycled, or burned in an appropriate waste incineration plant. Recyclable plastic parts are marked as follows:

	Polyethylene <ul style="list-style-type: none"> • Outer wrapping • Instructions bag
	Polypropylene <ul style="list-style-type: none"> • Straps
	Polystyrene foam <ul style="list-style-type: none"> • Corner protectors

The parts in wood and cardboard can be disposed of, respecting the current regulations in the country where the appliance is used.

F.5 6GN 1/1 – 10GN 1/1 – 10GN 2/1 models

F.5.1 Positioning

Install the appliance, taking all the safety precautions required for this type of operation, also respecting the relevant fire-prevention instructions.

If the appliance is installed in a place where there are corrosive substances (chlorine, etc.), it is advisable to go over all the stainless steel surfaces with a rag soaked in paraffin oil to create a protective film.

Arranging the appliance:

- position the appliance in the required place;
- adjust the height and levelling with the adjustment feet, also checking correct door closing.
-

F.5.2 Feet levelling

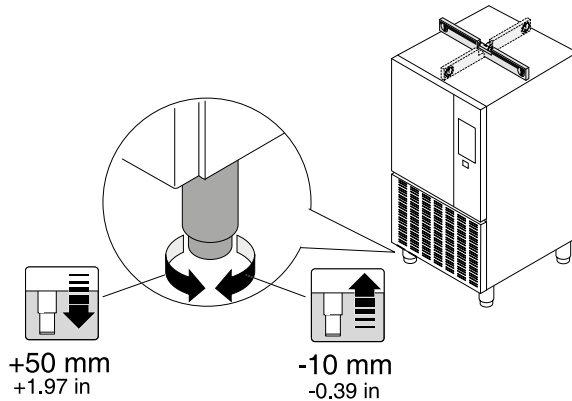

F.5.3 Back Spacer

6GN 1/1 – 10GN 1/1 – 10GN 2/1 models:

The spacer is necessary to keep the appliance at a certain distance from walls and allow correct cooling of the refrigerating unit elements.

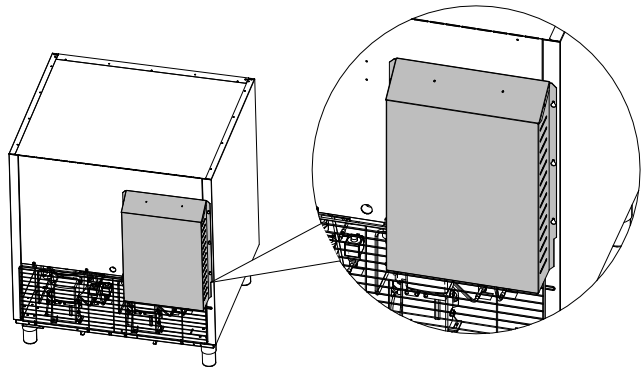

CAUTION

The manufacturer declines any liability for appliance malfunctioning or damage due to failure to use the spacer.

F.5.4 Condensate tray positioning



CAUTION

Install the condensate tray after the appliance positioning and levelling: do not use fork lifts when the condensate tray runners are mounted.

6GN 1/1 – 10GN 1/1 – 10GN 2/1 models:

- Fit the condensate tray support guides on the externally bottom of the appliance.

Proceed as shown in the figures:

1.

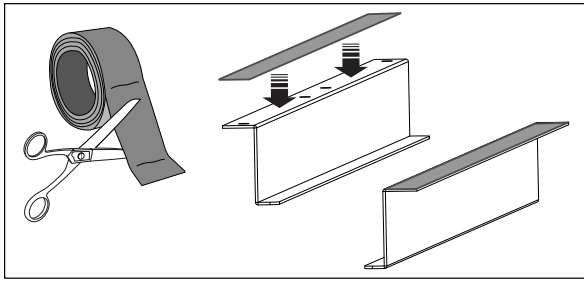

2.

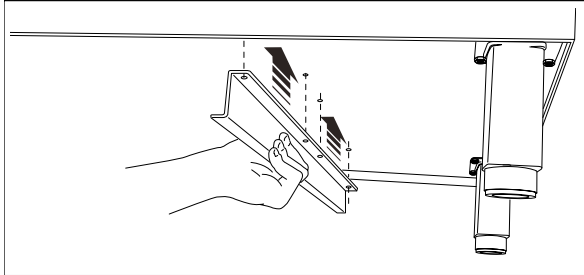

3.

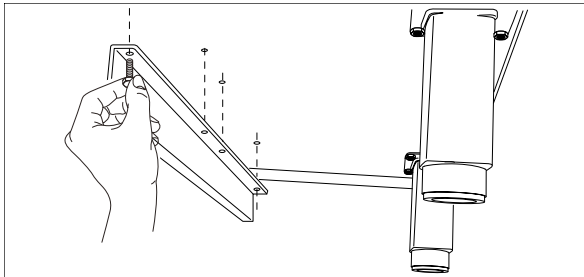

4.

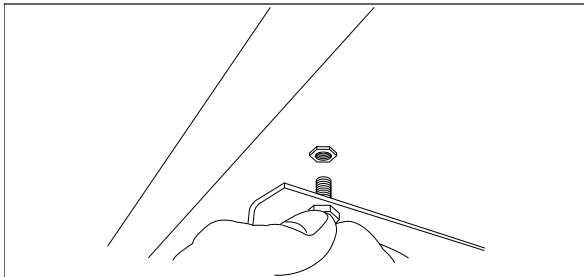

5.

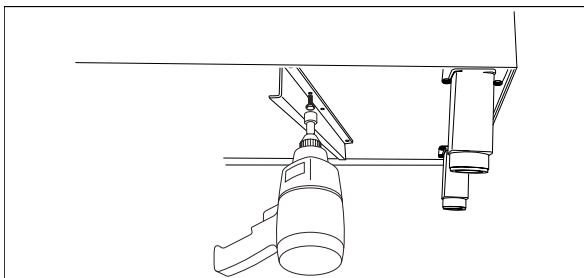

6.

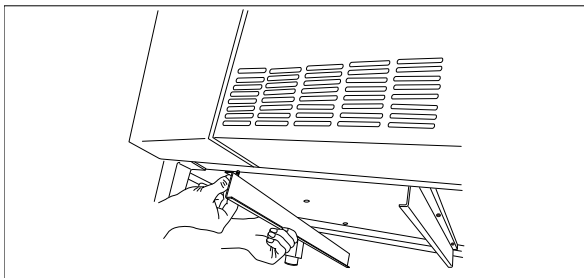

7. Take the tray located inside the compartment and slide it onto the support guides.

F.5.5 Stacking installation

If the 6 GN 1/1 model is arranged for the "Cook&Chill" column, follow the instructions given in the installation manual included in the kit.

The "Cook&Chill" column installations for safety reasons **MUST** be fixed to the wall by means of the appropriate accessory included in the appliance or to be ordered (kit "Wall brackets" code 922687):

Fix the stacked appliances to the wall by means of the 2 brackets. See the figure below.

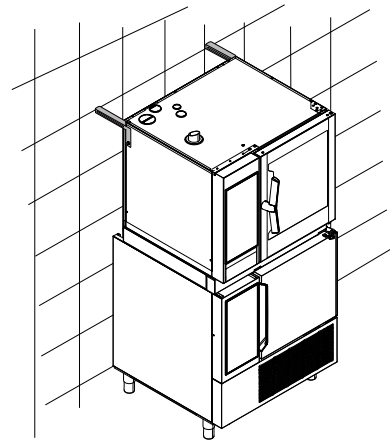

NOTE!

When installing the oven on top of the blast chiller, refer to the instructions in the oven handbook.

If the blast chiller has a top, remove it by following the instructions below:

1.

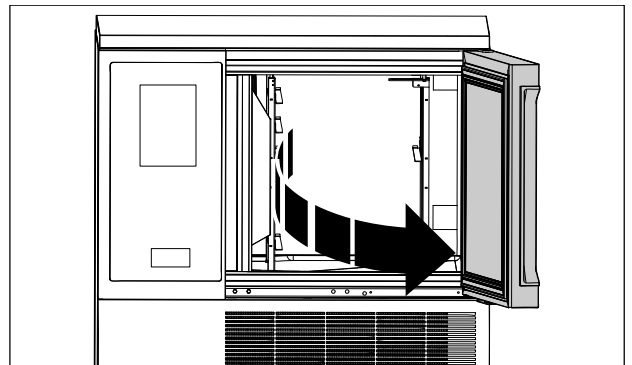

2.

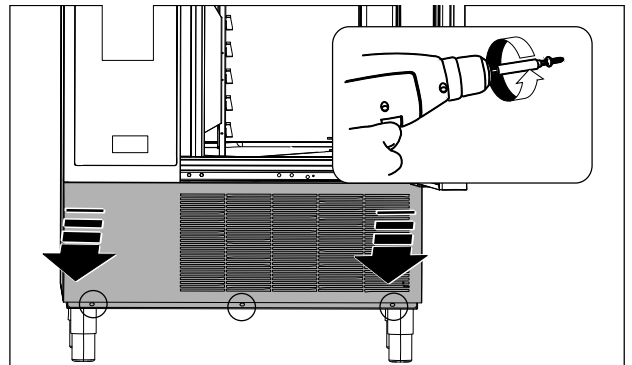

3.



4.

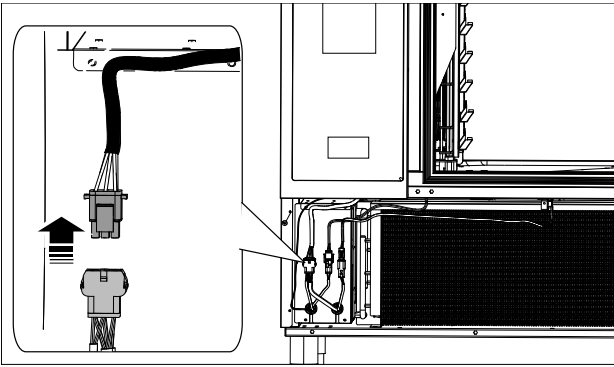

5.

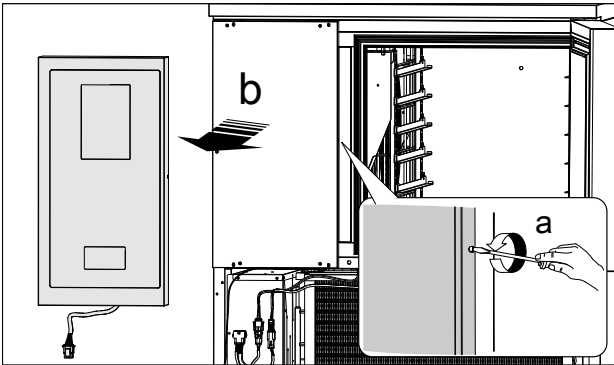

6.



7.

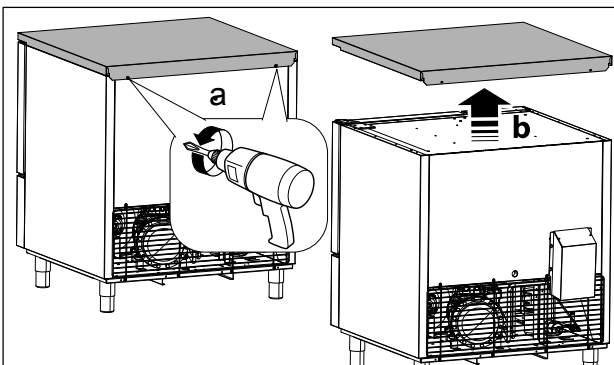

8.

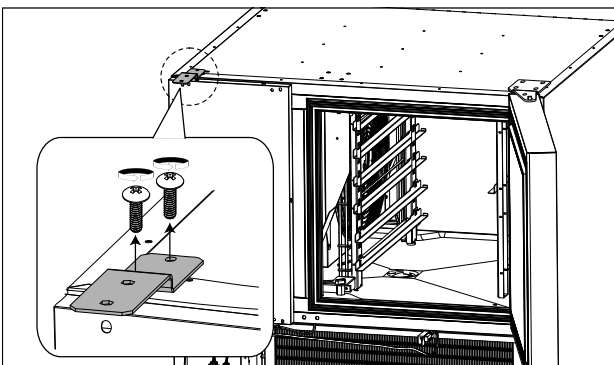

F.5.6 Positioning the top

If the 6 GN 1/1 model is arranged for the "Cook&Chill" column, but is not installed on the column, order the top kit.

For the installation follow the instructions included in the kit.

F.5.7 Draining water

• Manual draining (6GN 1/1 — 10GN 1/1 — 10GN 2/1):

The appliances have a drain hole to remove compartments liquids.

Open the drain plug;

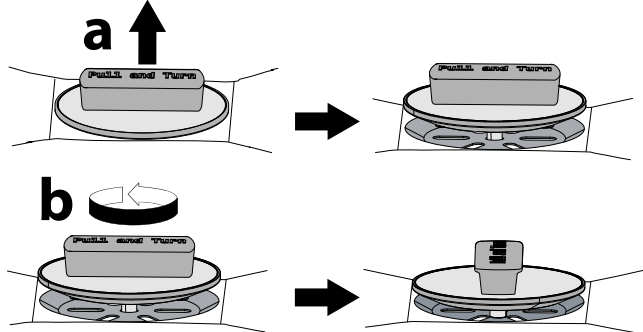

The liquids in the compartment run into the condensate tray located on the bottom of the cabinet. This tray must be emptied periodically.



NOTE!

Make sure the liquid collection tray has been emptied before opening the plug to drain compartment washing liquids.

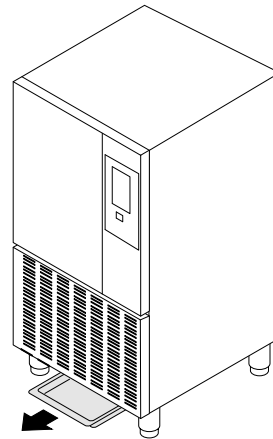

IMPORTANT

Close the drain plug immediately after the draining.

• Automatic draining (6GN 1/1 — 10GN 1/1 — 10GN 2/1):

Instead of having to periodically empty the liquid collection tray, the compartment drain hole "D" on the bottom of the appliance can be connected to a drainage system, or a rubber hose can be connected to the hole to run the water into a floor grate.

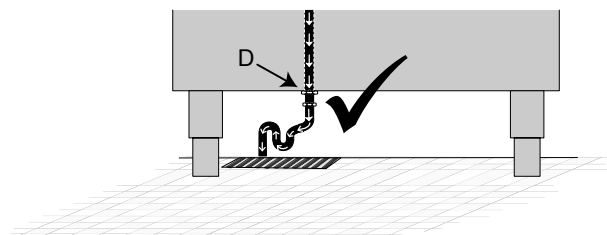

The drain diameter is 1½", therefore it is advisable to use a 1½" drain pipe or to a diameter 25 mm hose.

Emptying must occur through a trap into an open drain to prevent any backflow from the drainage system reaching the internal pipes of the appliance. Make sure there are no restrictions in the flexible pipes or elbows in the metal pipes along the entire drainage path. Avoid horizontal sections that cause water to collect and stagnate.

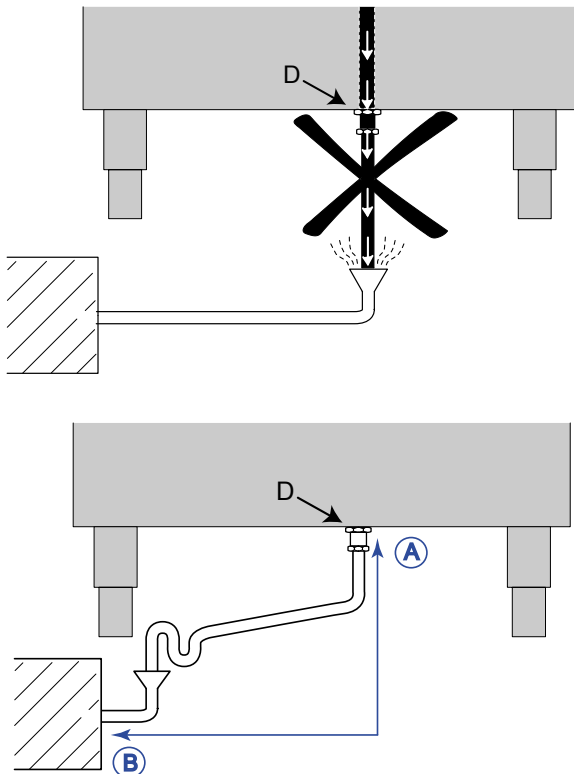

From A to B: 1,5 meter (5 feet) minimum.



NOTE!

Before opening the plug to drain compartment washing liquids, make sure the appliance has been connected to a water drain trap system or that the tray has been emptied.

F.5.8 Multifunctional internal structure

The appliances are provided with a multifunctional internal structure to insert different types of trays (for example pastry trays).

To modify the rack position see the instructions below:

1.

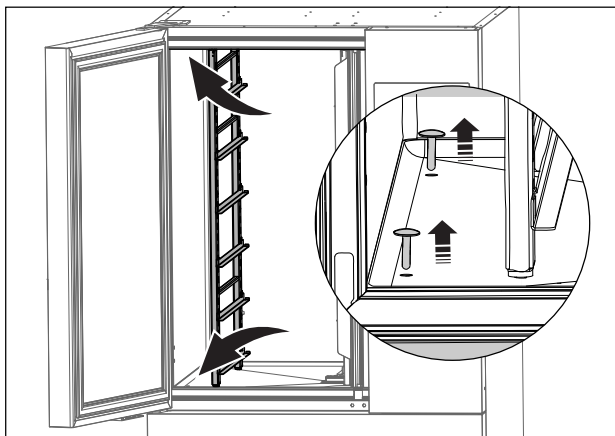

2.

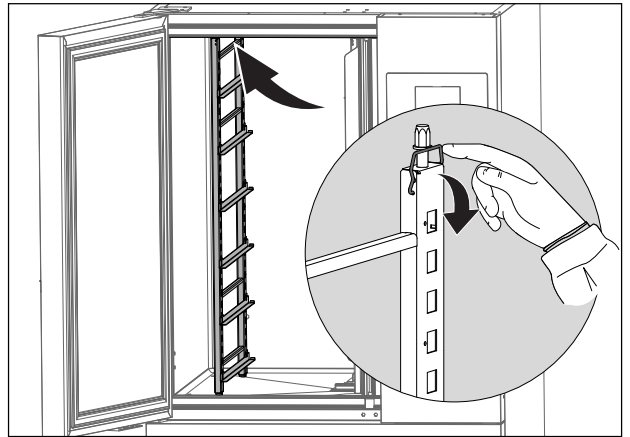

3.

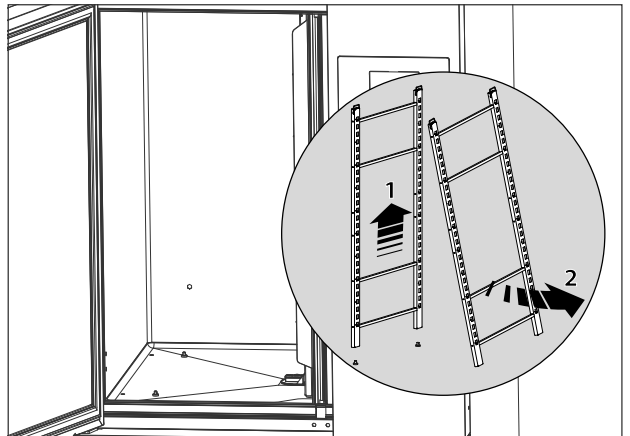

4.

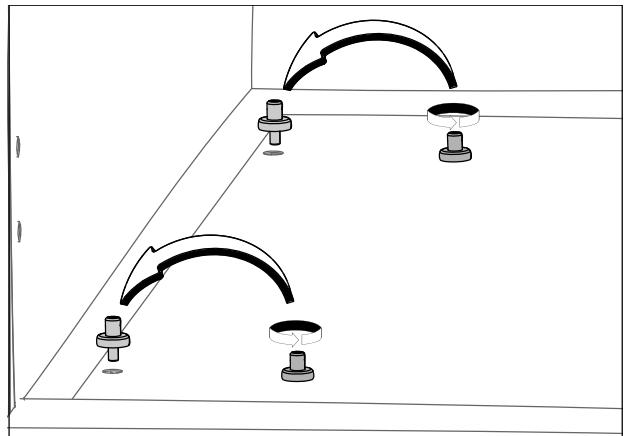

5.

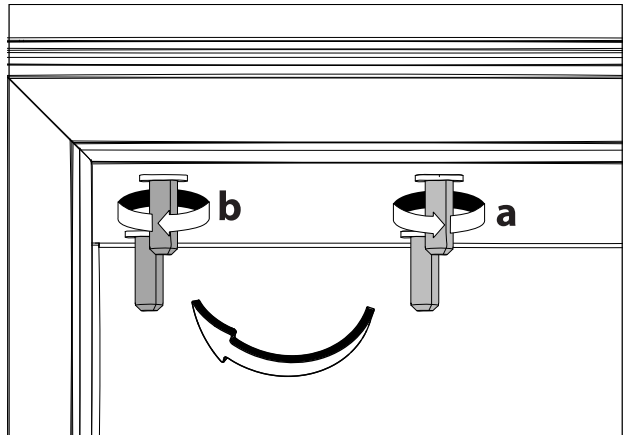

6.

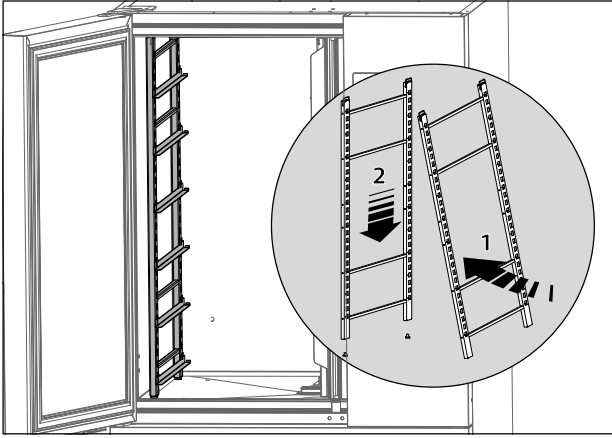

7.

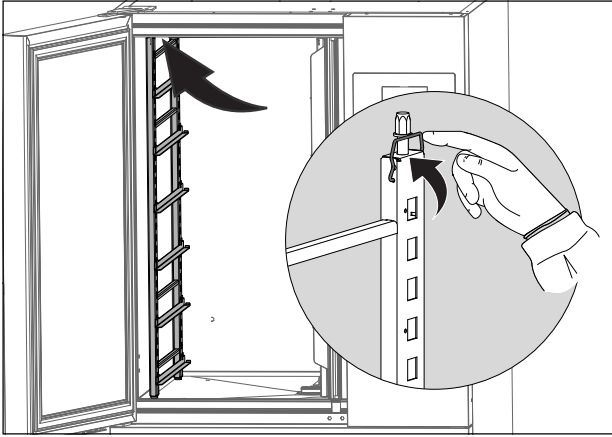

8.

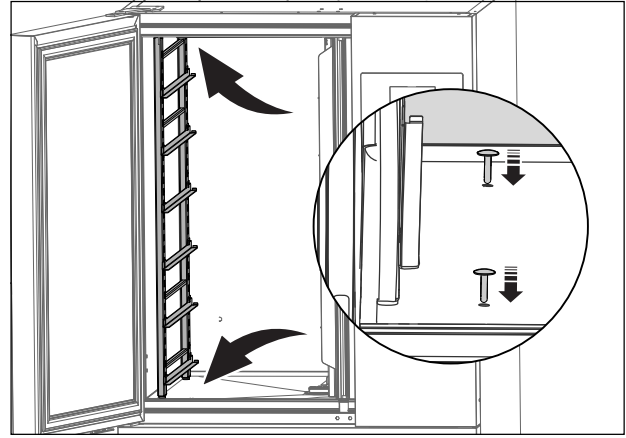

NOTE!

The tray supports are removable. It is possible to adjust their distance as necessary.

G APPLIANCE SETUP

G.1 Introduction

When the appliance is switched on for the first time, an automatic procedure(Wizard), checks if all the parameters are properly set.

Wizard helps the specialised personnel, step by step, to update all the required appliance settings.



IMPORTANT

- This setup is meant to be carried out **ONLY** by a specialised personnel.
- Always refer to the “service manual” to change or modify appliance settings.

H MACHINE DISPOSAL



WARNING

Refer to “*Warning and Safety Information*”.

H.1 Procedure regarding appliance disposal

At the end of the product's life-cycle, make sure it is not dispersed in the environment.

Different regulations are in force in the various countries, therefore comply with the provisions of the laws and competent bodies in the country where appliance disposal takes place.

Before disposing of the appliance, make sure to carefully check its physical condition, and in particular any parts of the structure that can give or break during dismantling.

The appliance's parts must be disposed in a differentiated way, according to their different characteristics (e. g. metals, oils, greases, plastic, rubber, etc.) remembering that the compressor contains lubricant oil and refrigerant fluid which can be

recycled, and that the refrigerator components are special waste assimilable with urban waste.

Depending on the model, the doors must be removed before dismantling the appliance.

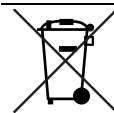

The symbol on the product indicates that this product should not be treated as domestic waste, but must be correctly disposed of in order to prevent any negative consequences for the environment and human health. For further information on the recycling of this product, contact the local dealer or agent, the Customer Care service or the local body responsible for waste disposal.



NOTE!

When dismantling the appliance, any marking, this manual and other documents concerning the appliance must be destroyed.

CE