

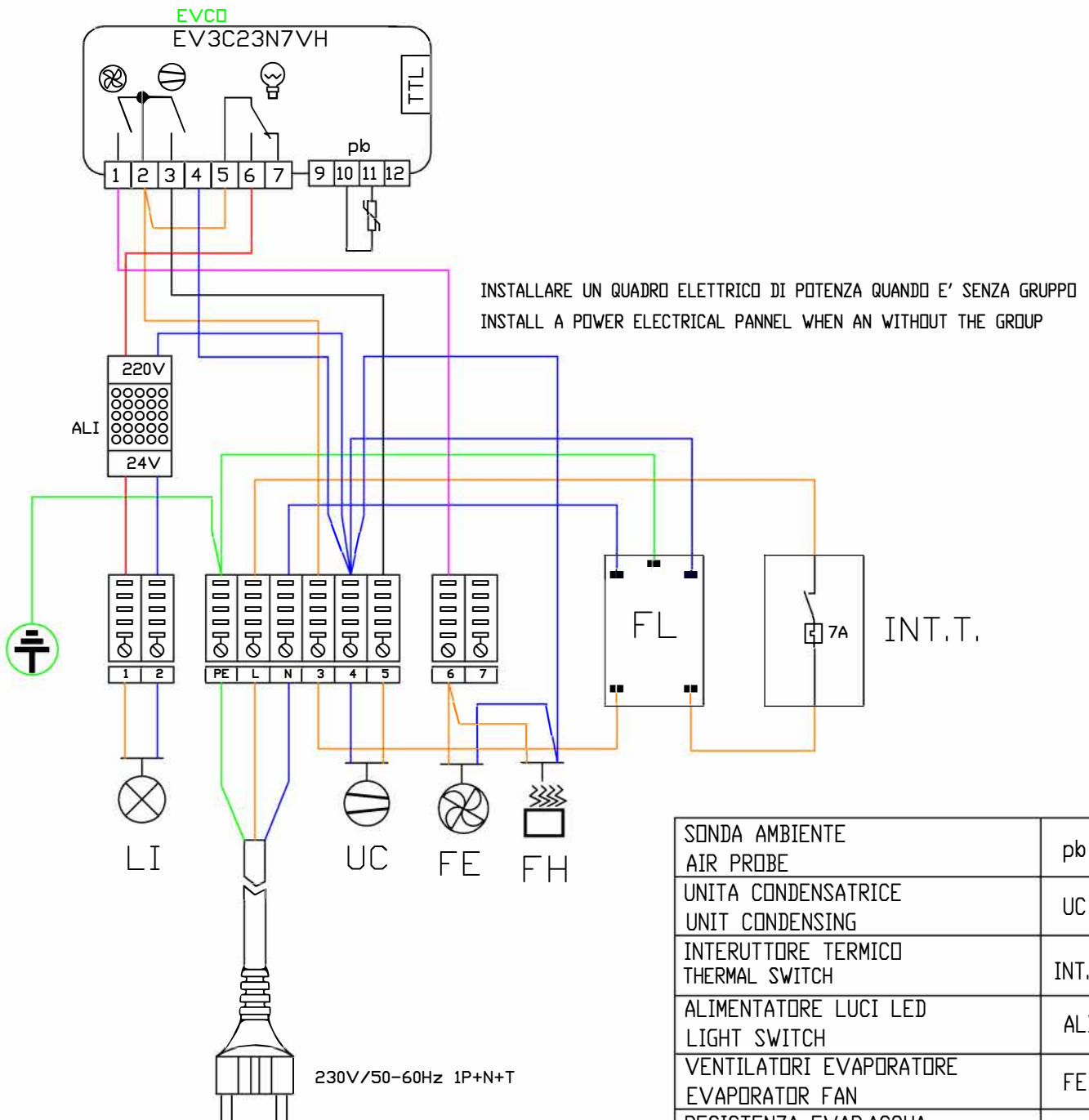



MOD : MD15/A7-R2B

Production code : OI150PSVGD110BH_1

08/2025



SONDA AMBIENTE AIR PROBE	pb
UNITA CONDENSATRICE UNIT CONDENSING	UC
INTERUTTORE TERMICO THERMAL SWITCH	INT.T.
ALIMENTATORE LUCI LED LIGHT SWITCH	ALI
VENTILATORI EVAPORATORE EVAPORATOR FAN	FE
RESISTENZA EVAP.ACQUA HEATER WATER	FH
LUCI LED LED LIGHT	LI
FILTRO ANTIDISTURBO SUPPLY FILTER	FL

Approved By:	Elettrical Schematic		Date
	Model	Modena Line	06/09/2022
	Details:	700-1000-1200-1500	
	Dettagli:	CON ILL.BARRE LED VERTICALE	

IL FRIGORIFERO DEVE ESSERE ALLACCIATO AD UN INTERRUPTORE DIFFERENZIALE ONNIPOLARE ADEGUATO ALLA POTENZA CON $i_{\Delta}=0,03A$ E COLLEGATO ALL'IMPIANTO DI MESSA A TERRA