

02/2021

Mod: EFP/6R-M

Production code: P07EN10034

Schemi elettrici

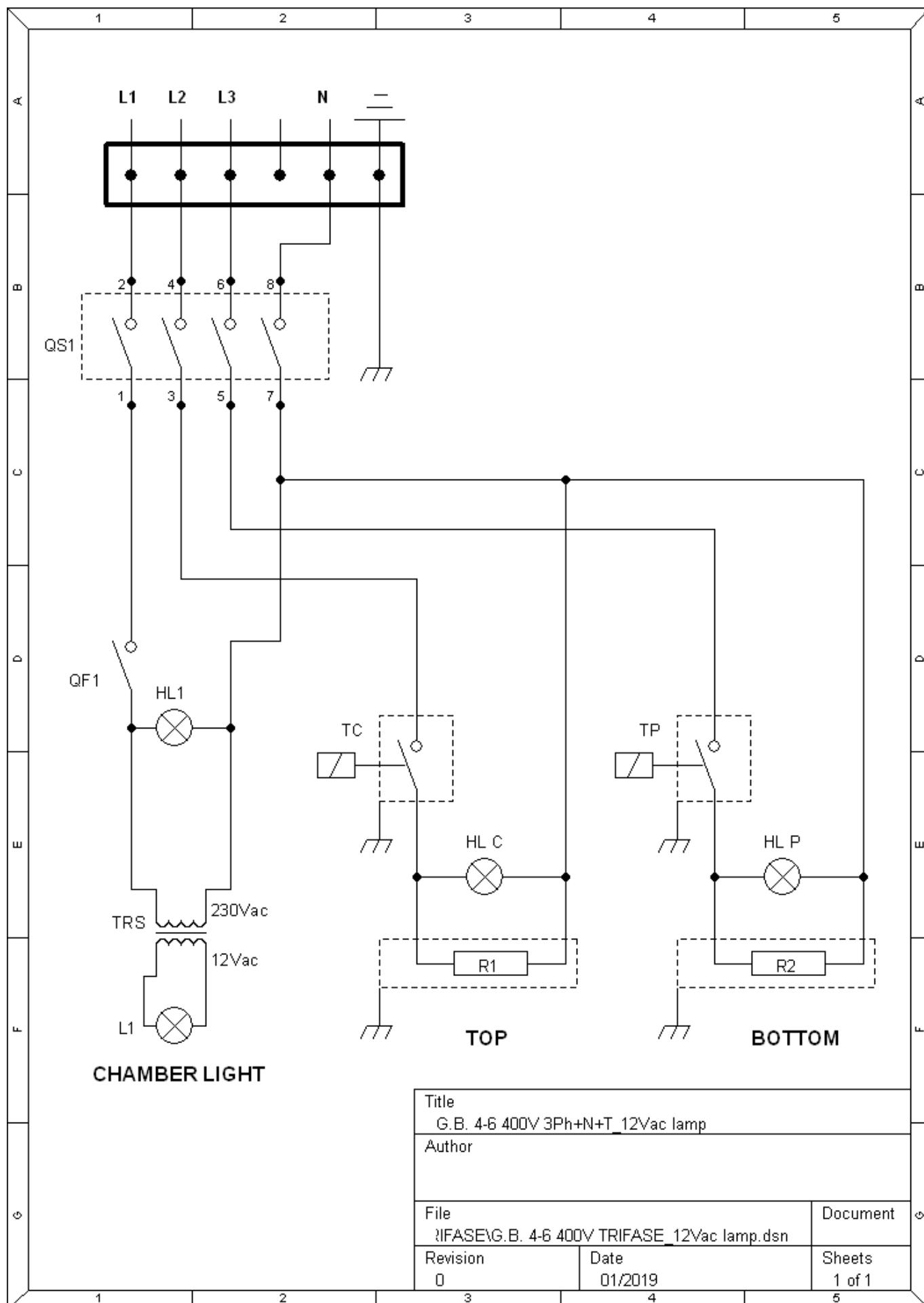

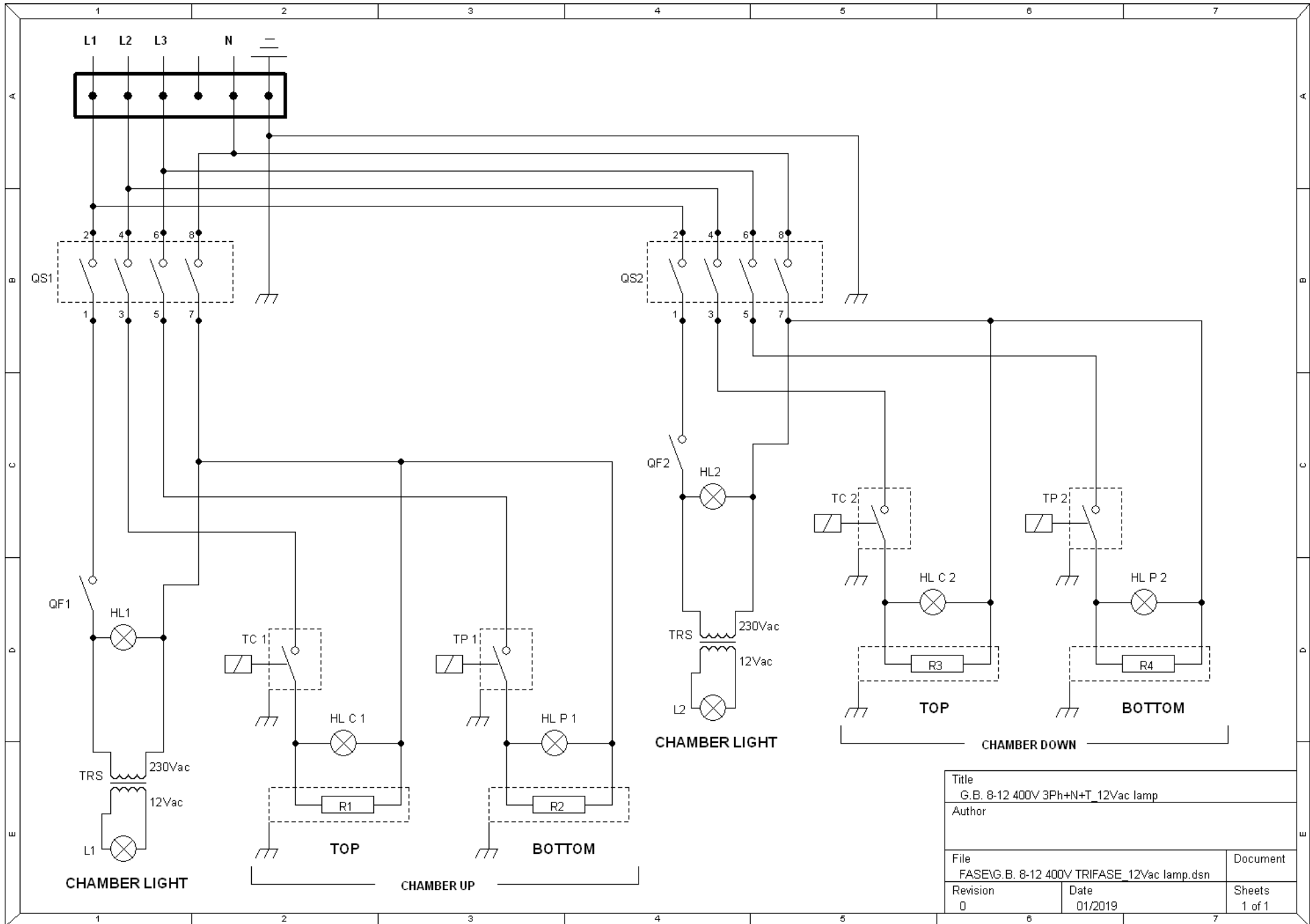

Title		G.B. 8-12 400V 3Ph+N+T_12Vac lamp	
Author			
File		Document	
FASE\G.B. 8-12 400V TRIFASE_12Vac lamp.dsn			
Revision	Date	Sheets	
0	01/2019	1 of 1	