

10/2021

Mod: EFP/6R-M

Production code: P07EN10034

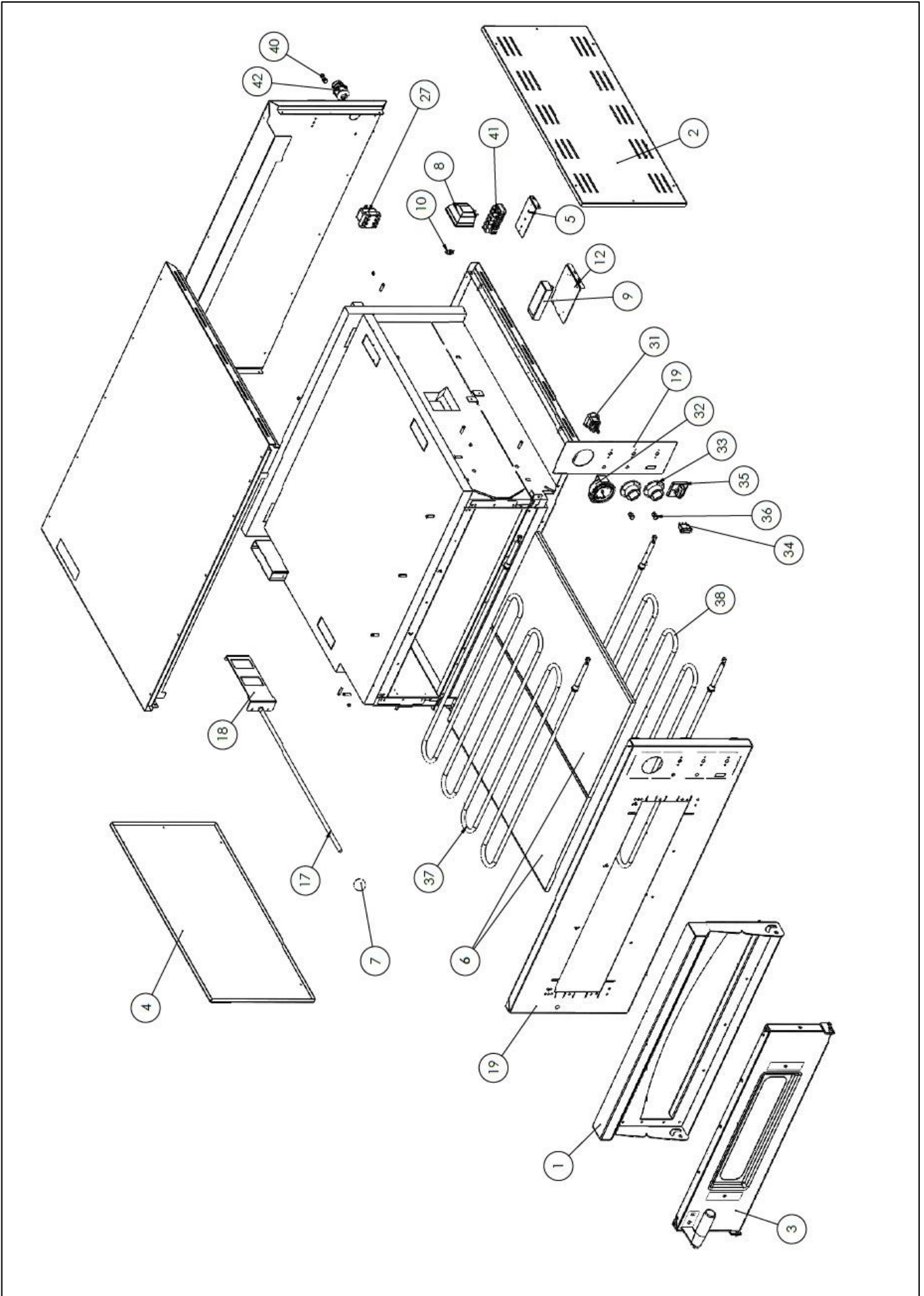

Pos.	Code	Description
1	S53PT55018	Frame door 4-6-8-12 MAX Diamond
2	S40FN55015	Right side panel 4-6L MAX Diamond
3	S35FN55066	Complete door 4-6-8-12 MAX Diamond
4	S40FN55013	Left side panel 4-6L MAX Diamond
5	S49IN55001	Terminal board support
6	A95OO65008	Refractory stone 700x350x14 mm
7	A90MP65001	Spheric knob PLX.30-M8-C9
8	A87IL73009	Complete lamholder 80X65 with lamp 12V 20W 450°C and glass
9	A87IL72012	Transformer 40VA 50/60Hz 230V±12V
10	A87IL72013	Halogen lamp 12V 20W G4 T=450°C
12	S49IN55011	Transformer support
17	A83CH55005	Fireplace closing rod M8x580
18	S50CF55006	Fireplace closing
19	S37FN55029	Painted facade 4-6 MAX Diamond
27	A88TX85001	Three phases safety thermostat
30	A93OL65126	Comands label Diamond 2019
31	A88TX77005	Single-phase thermostat Tmax=450°
32	A88TC83001	Analogue thermometer 0-500°C
33	S73FN55006	Grey knob thermostat Diamond
34	A87AZ69006	Red single-pole switch
35	A87AZ69004	Main switch
	A87AZ69011	Grey/black plate knob 48x48 for main switch
36	A87IL72005	Pilot light
37	A87RZ65005	Upper heating element 2800W-230V
38	A87RZ65074	Lower heating element 1900W-230V
40	A86EL48001	Equipotential connection
42	A86EL46004	Cable gland OBO 106 PG 21
	A86EL47003	Nut for cable gland OBO 106 PG 11

Pos.	Code	Description
1	S53PT55018	Frame door 4-6-8-12 MAX Diamond
2	S40FN55041	Right side panel 6-9 MAX Diamond
3	S35FN55066	Complete door 4-6-8-12 MAX Diamond
4	S40FN55043	Left side panel 6-9 MAX Diamond
5	S49IN55001	Terminal board support
6	A95OO65009	Refractory stone 1050x350x14 mm
7	A90MP65001	Spheric knob PLX.30-M8-C9
8	A87IL73009	Complete lamholder 80X65 with lamp 12V 20W 450°C and glass
9	A87IL72012	Transformer 40VA 50/60Hz 230V±12V
10	A87IL72013	Halogen lamp 12V 20W G4 T=450°C
12	S49IN55011	Transformer support
17	A83CH55005	Fireplace closing rod M8x580
18	S50CF55006	Fireplace closing
19	S37FN55029	Painted facade 4-6 MAX Diamond
27	A88TX85001	Three phases safety thermostat
30	A93OL65126	Comands label Diamond 2019
31	A88TX77005	Single-phase thermostat Tmax=450°
32	A88TC83001	Analogue thermometer 0-500°C
33	S73FN55006	Grey knob thermostat Diamond
34	A87AZ69006	Red single-pole switch
35	A87AZ69004	Main switch
	A87AZ69011	Grey/black plate knob 48x48 for main switch
36	A87IL72005	Pilot light
37	A87RZ65065	Upper heating element 3650W-230V
38	A87RZ65065	Lower heating element 3650W-230V
40	A86EL48001	Equipotential connection
42	A86EL46004	Cable gland OBO 106 PG 21
	A86EL47003	Nut for cable gland OBO 106 PG 11

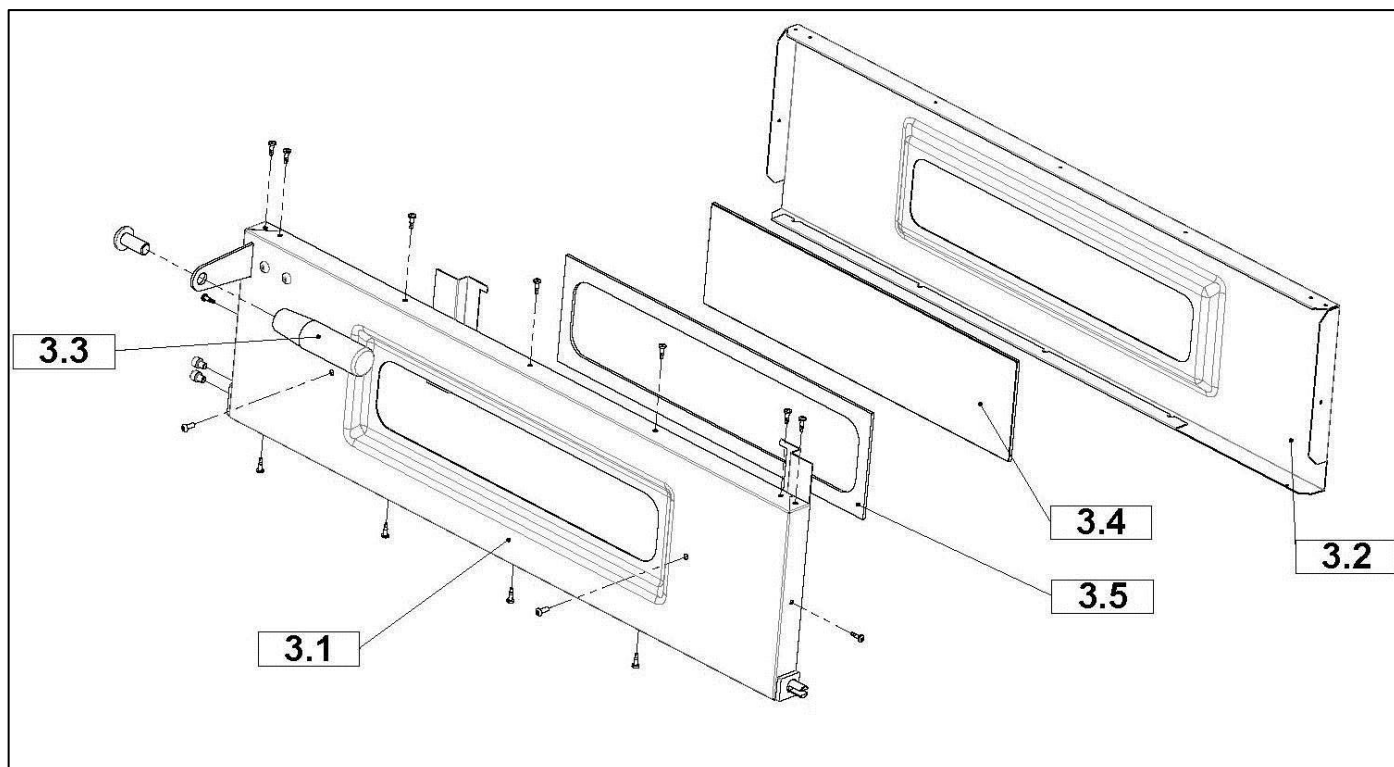

Pos.	Code	Description
3.1	S66PT55025	Entry door assembly 4-6-8-12 MAX
3.2	S34FN55016	Counterdoor assembly 4-6-8-12 MAX
3.3	A90MI65003	Elesa handle I 280/115 M12
3.4	A00PT55003	Entry glass ceramic plate
3.5	A94GU65002	Joint Entry

COMANDS PANEL

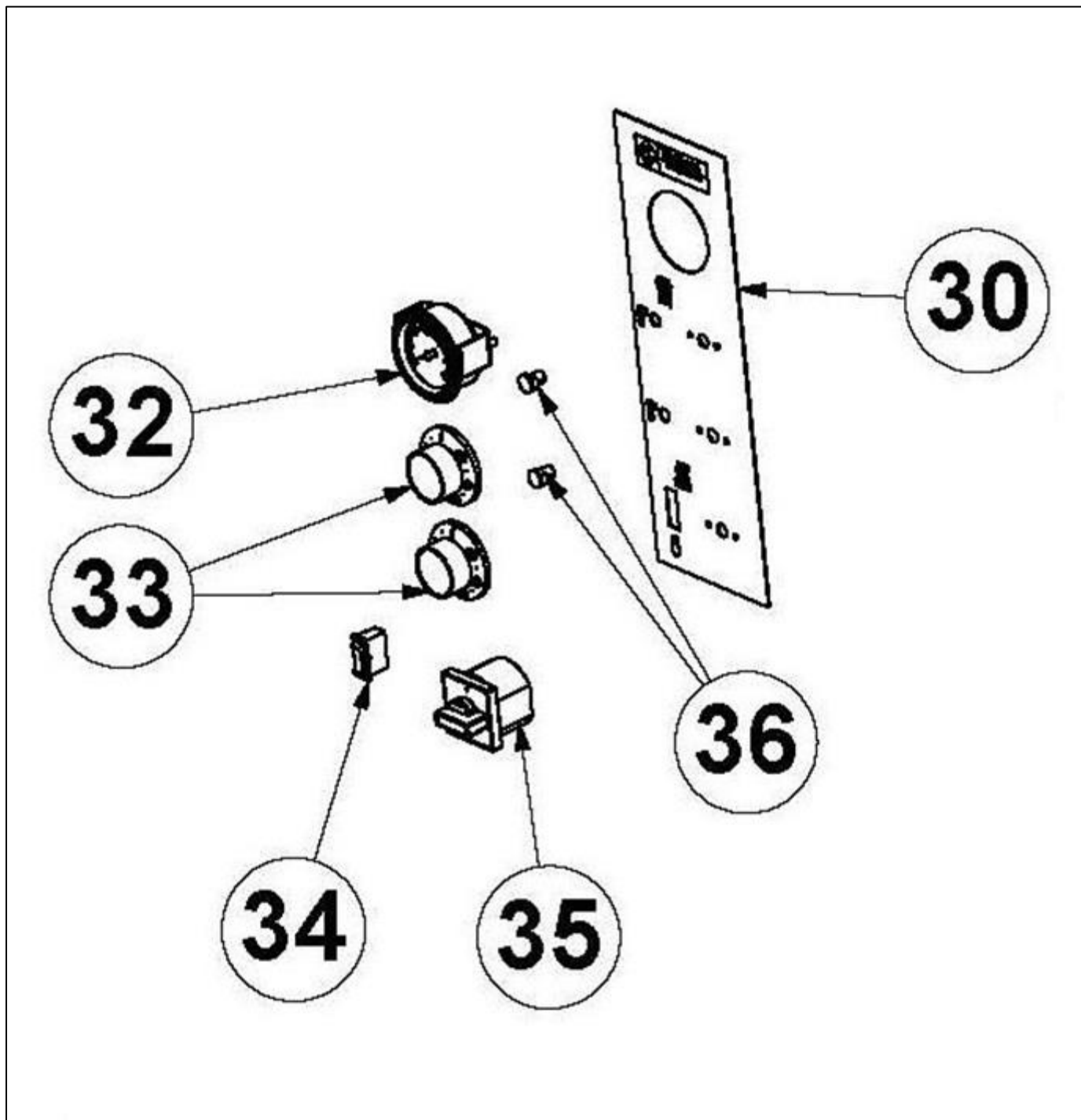

Pos.	Code	Description
30	A93OL65126	Comands label Diamond 2019
31	A88TX77005	Single-phase thermostat Tmax=450°
32	A88TC83001	Analogue thermometer 0-500°C
33	S73FN55006	Grey knob thermostat Diamond
34	A87AZ69006	Red single-pole switch
35	A87AZ69004	Main switch
	A87AZ69011	Grey/black plate knob 48x48 for main switch
36	A87IL72005	Pilot light