

02/2021

Mod: CGD/2-DG--230/3-

Production code: CR835/2CD-HL(230/3)

Données techniques du four **Caravaggio CR 5** | double

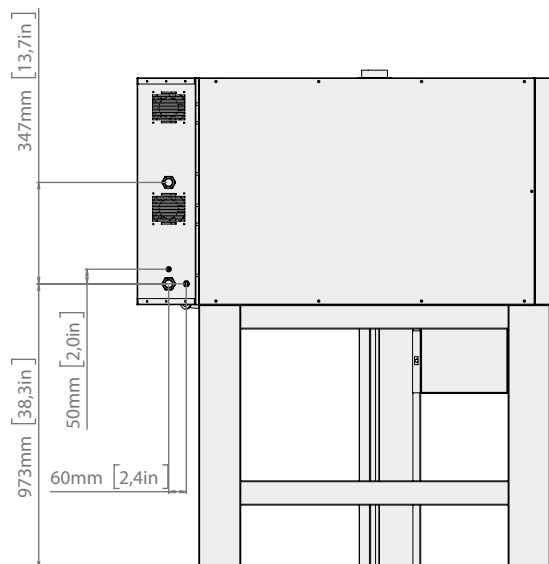
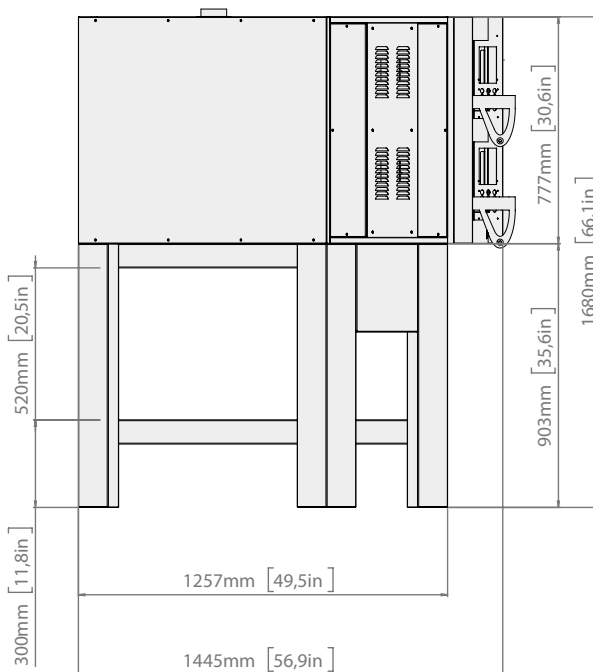
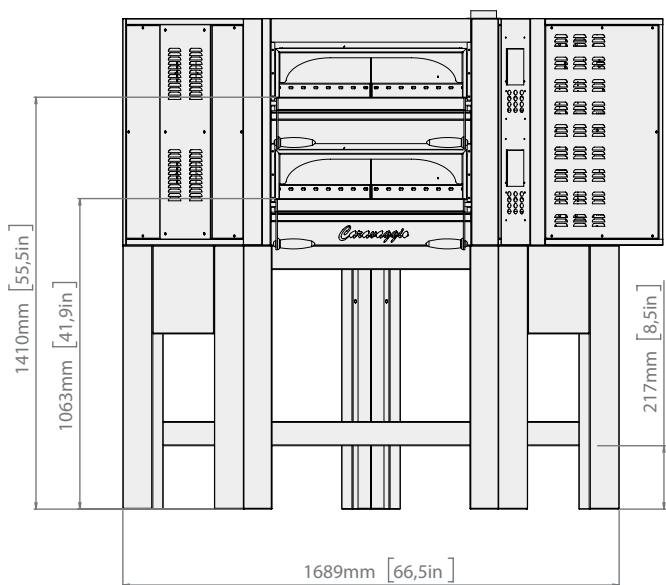

*poids du four **CR 5 double***
450 kg - 992 lb

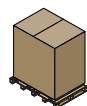

*poids emballage +
four complet **CR 5 double***
494 kg - 1089 lb

*dimensions
emballage du four **CR 5 double***
1370x1450x960 [53.94x53.94x 7.8 in.]

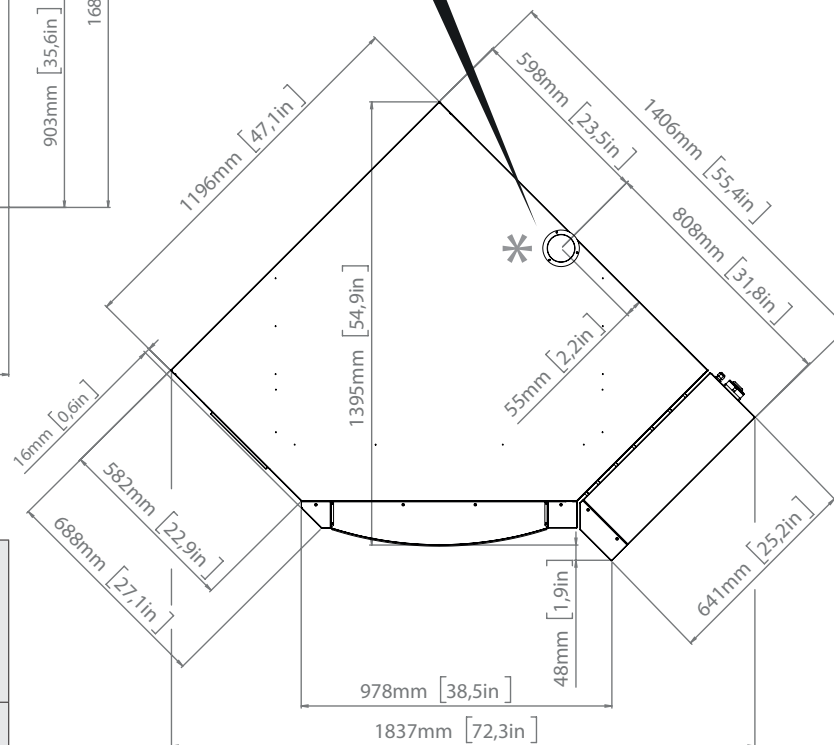
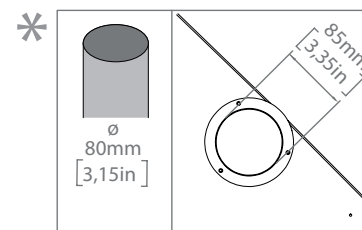

Données techniques du four **Caravaggio CR 5** | capacité

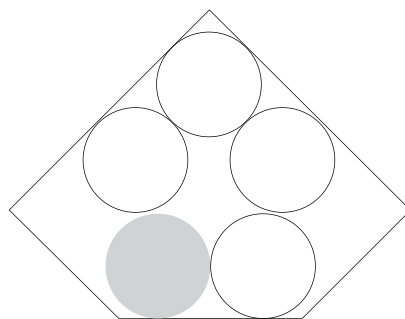
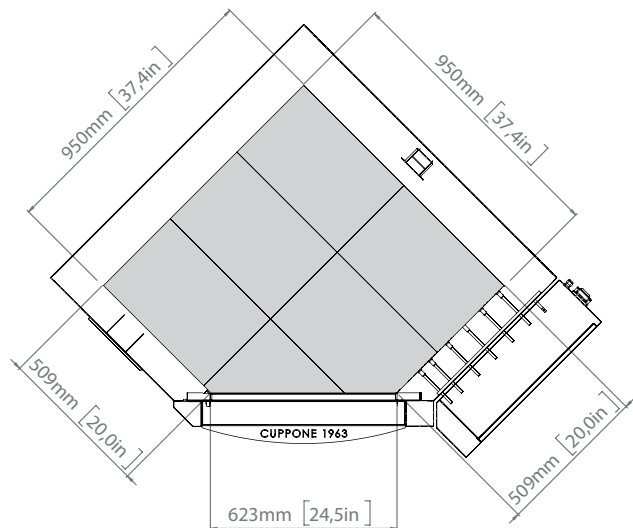

PIZZA Ø 35 cm [Ø 13.78 in.]

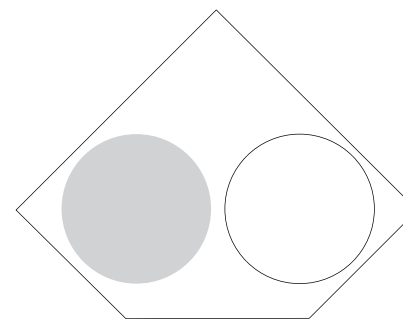

PIZZA Ø 50 cm [Ø 19.69 in.]

	Ø PIZZAS	PRODUCTIVITÉ HORAIRE	FOURNÉES
●	Ø 35 cm [Ø 13.78 in.]	50-55 pizzas	10-11
●	Ø 50 cm [Ø 19.69 in.]	18-20 pizzas	9-10

ALIGNEMENT DU FOUR AVEC LE SUPPORT

Faire coïncider les angles du four avec ceux du support (voir **A**, **B** et **C**)

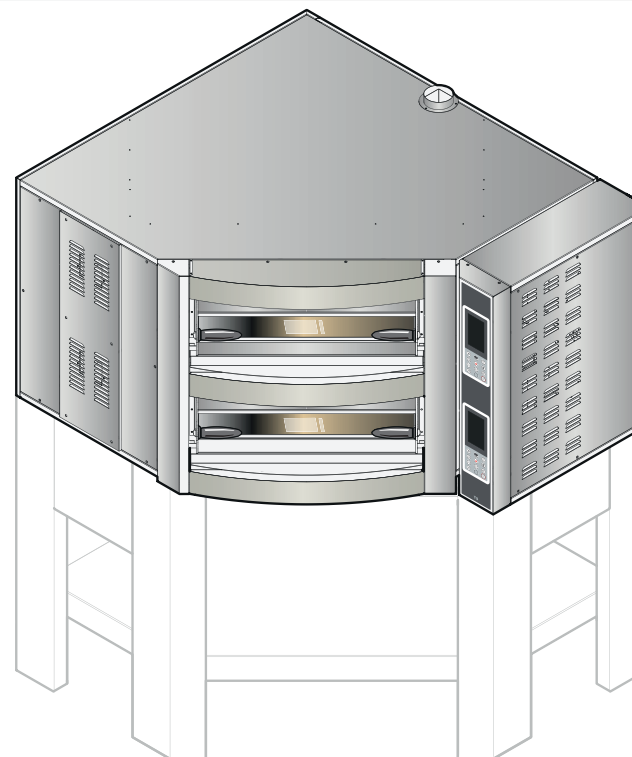
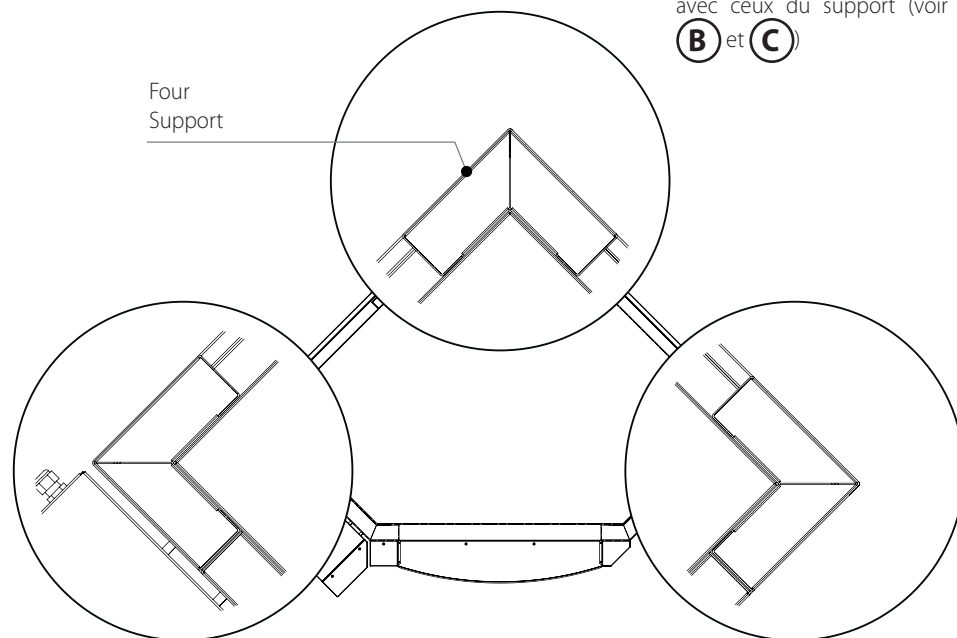

Données techniques du four **Caravaggio CR 8** | double

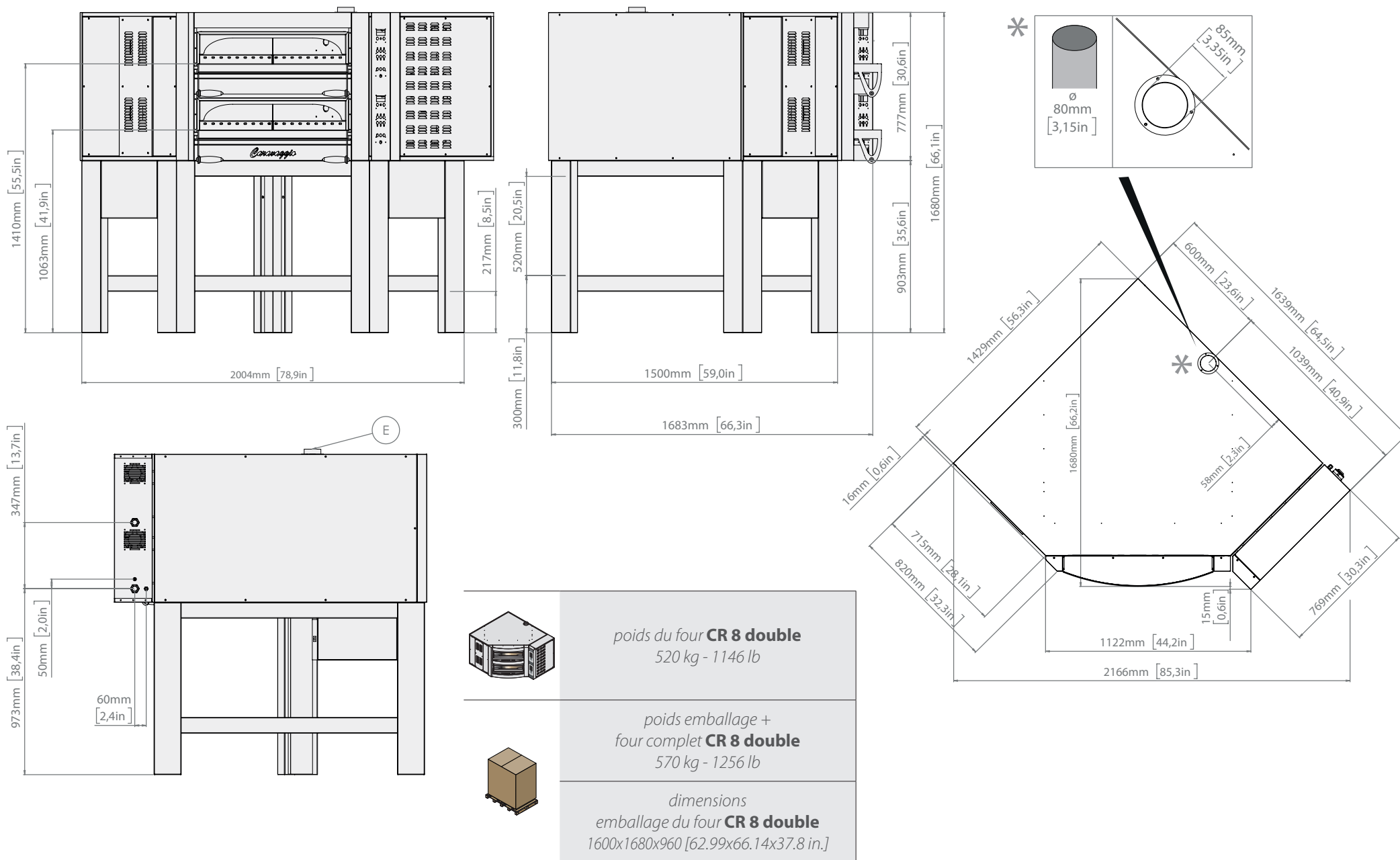

Données techniques du four **Caravaggio CR 8** | capacité

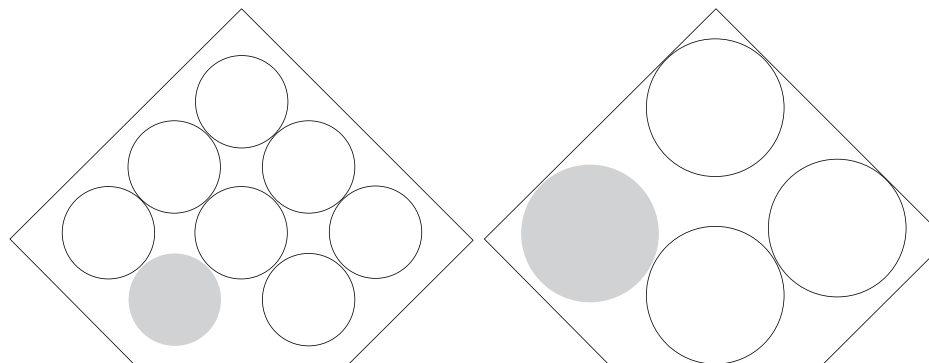
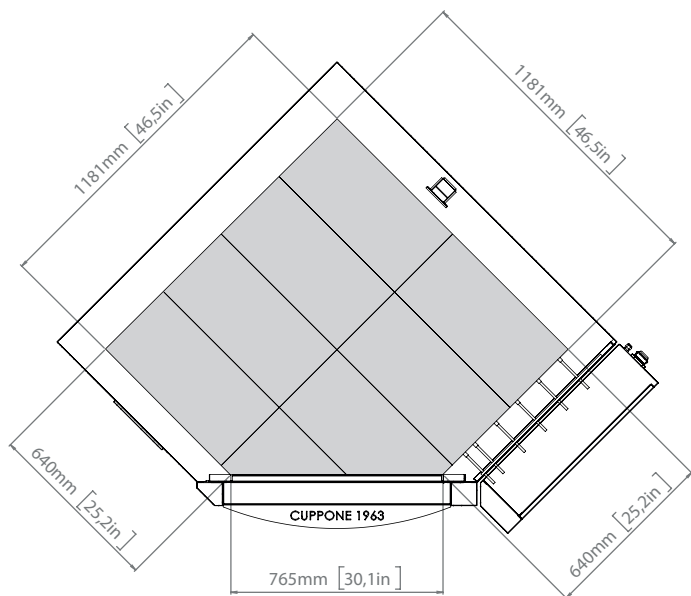

PIZZA Ø 35 cm [Ø 13.78 in.]

PIZZA Ø 50 cm [Ø 19.69 in.]

	Ø PIZZAS	PRODUCTIVITÉ HORAIRE	FOURNÉES
●	Ø 35 cm [Ø 13.78 in.]	80-88 pizzas	10-11
●	Ø 50 cm [Ø 19.69 in.]	36-40 pizzas	9-10

ALIGNEMENT DU FOUR AVEC LE SUPPORT

